

회로 이론/실습

12. 직렬 RL 회로

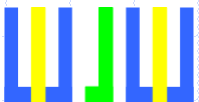

12. 직렬 RL 회로

12-1. 목적 및 배경

12-2. 소요 부품 및 장비

12-3. 유용한 공식

12-4. 주파수에 따른 임피던스

12-5. 위상의 변화

12-6. 전압과 전류의 위상

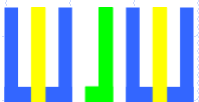

12-1. 목적 및 배경

- ✓ 직렬로 연결된 RL 회로의 특성을 이해한다.
- ✓ 주파수에 따른 임피던스의 변화를 확인한다.
- ✓ 주파수에 따른 위상의 변화를 확인한다.
- ✓ 전압과 전류의 위상변화를 확인한다.

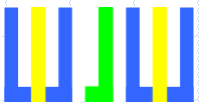

12-2. 소요 부품 및 장비

✓ 부품

- ✓ 저항 (1/4W) : 10 Ω , 1k Ω
- ✓ 인덕터 : 10mH

✓ 장비

- ✓ 브레드 보드
- ✓ 디지털 멀티미터 (Digital Multi-Meter)
- ✓ 직류 전원 공급 장치 (DC Power Supply)
- ✓ 오실로스코프 (Oscilloscope)
- ✓ 신호 발생기 (Function Generator)

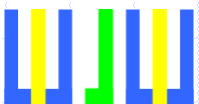

12-3. 유용한 공식

✓ 직렬 RL 회로의 임피던스

$$Z = R + j2\pi fL = R + jX_L = \sqrt{R^2 + X_L^2} \angle \tan^{-1}\left(\frac{X_L}{R}\right)$$

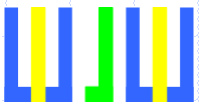

12-4. 주파수에 따른 임피던스

- 다음과 같이 회로를 연결하고, 신호 발생기를 조절하여 주파수 1kHz, 10Vpp 의 정현파가 나오도록 한다.

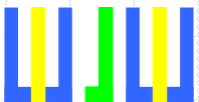
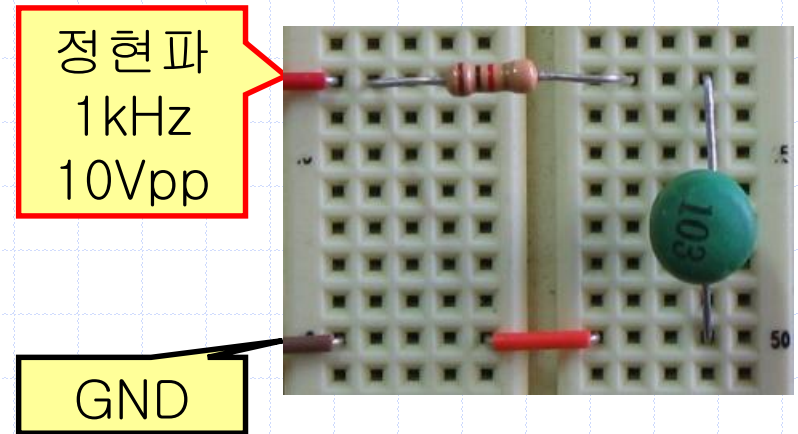
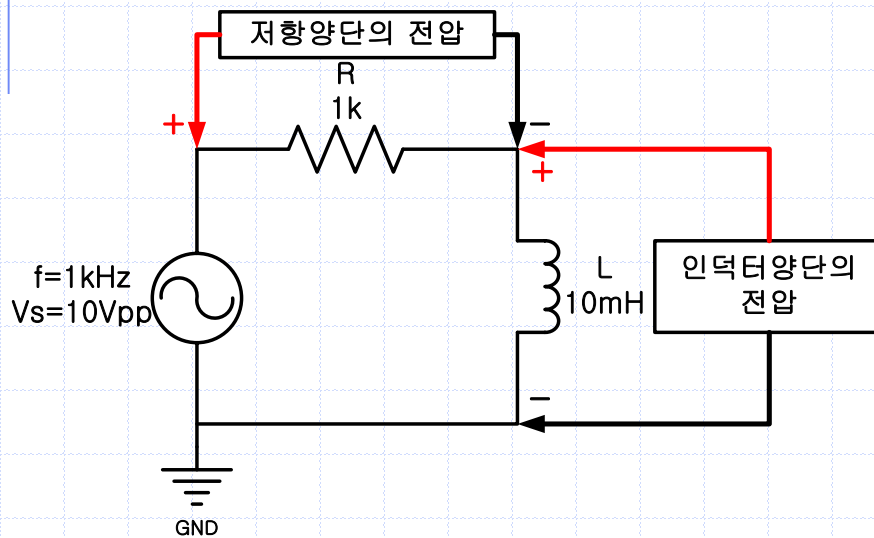

12-4. 주파수에 따른 임피던스

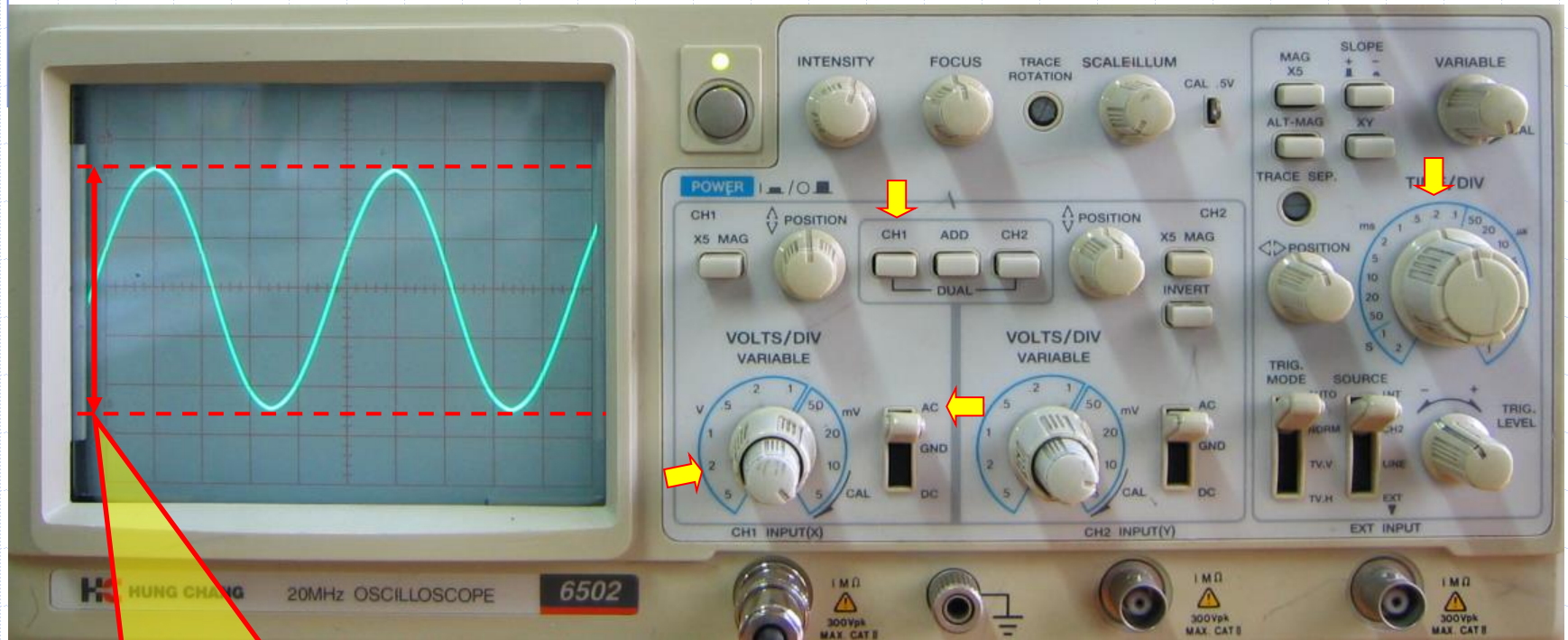

$$5\text{칸} \times 2\text{V/DIV} = 10\text{Vpp}$$

12-4. 주파수에 따른 임피던스

- ✓ 오실로스코프의 CH 1 을 이용하여 저항 양단의 전압을 측정한다.

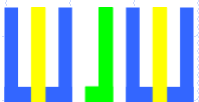
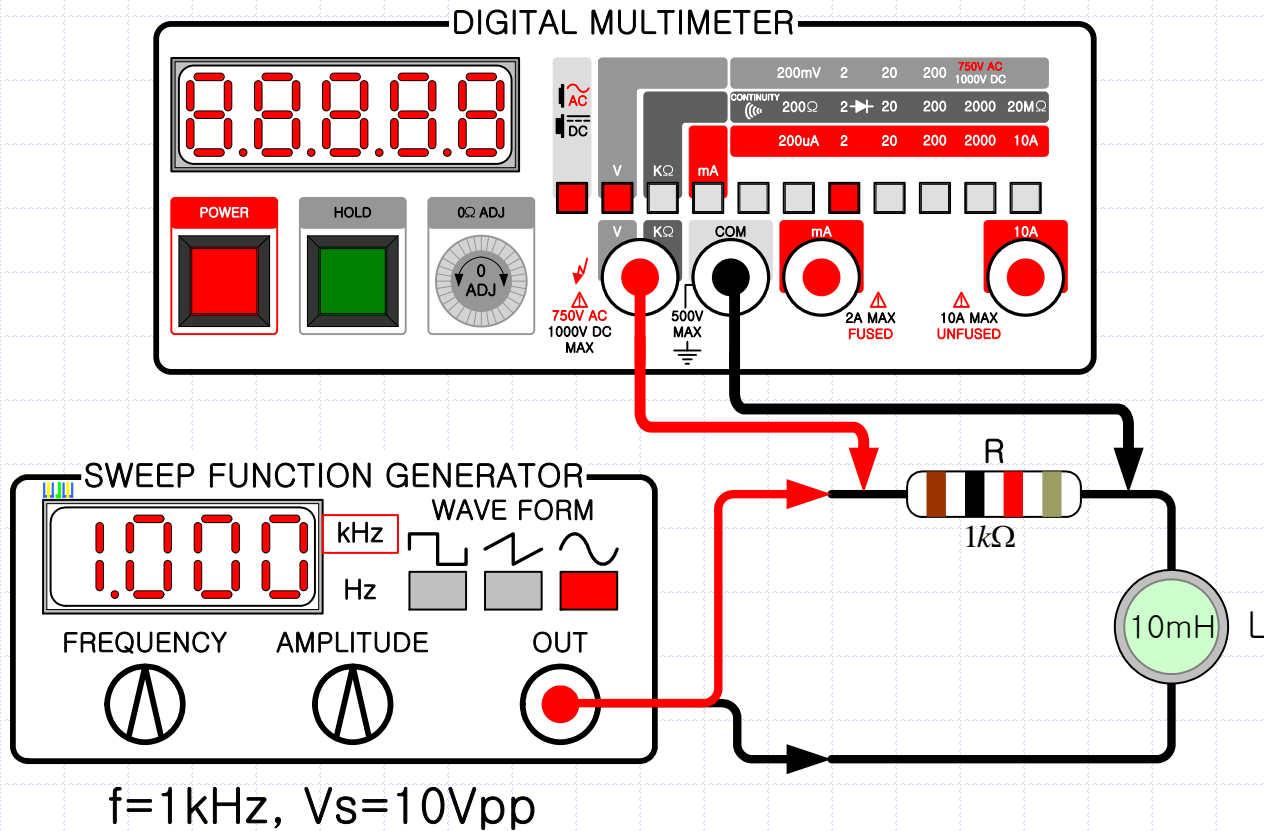

12-4. 주파수에 따른 임피던스

✓ 주파수 : 1kHz

$$V_{R(rms)} = 3.215V$$

$$V_{R(p-p)} = 3.215V \times 2 \times 1.414 = 9.09V_{pp}$$



$$I_T(\text{실험}) = \frac{V_R}{R} = \frac{9.09V}{1k\Omega} = 9.09mA_{pp}$$

정현파
1kHz
10Vpp

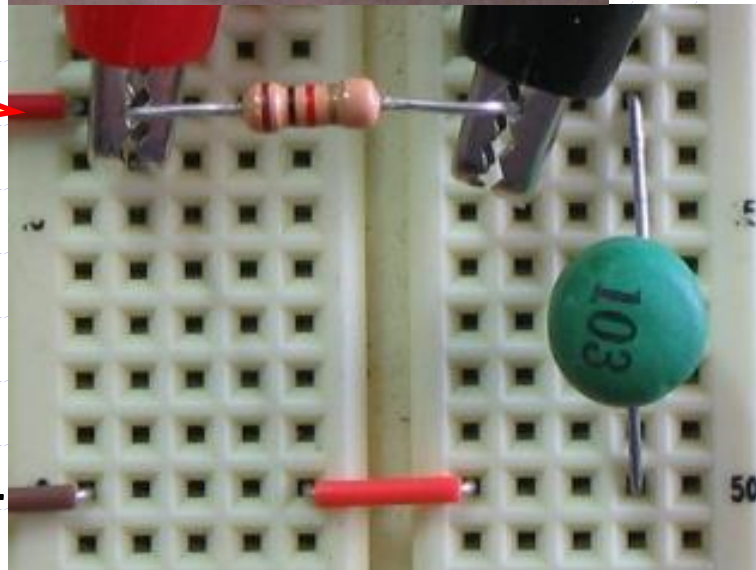

GND

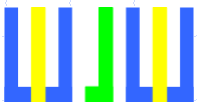

12-4. 주파수에 따른 임피던스

- ✓ 오실로스코프의 CH 1 을 이용하여 인덕터 양단의 전압을 측정한다.

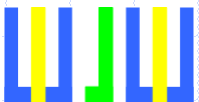
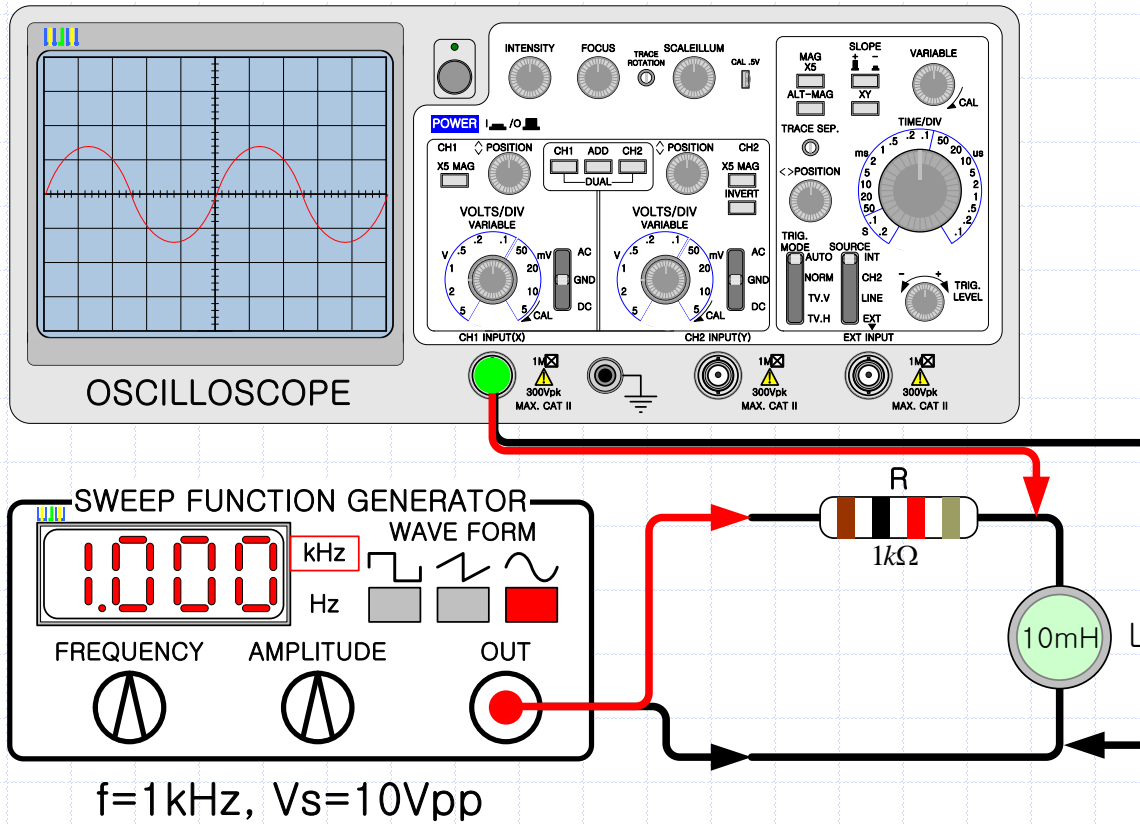

12-4. 주파수에 따른 임피던스

✓ 주파수 : 1kHz

$V_c : 6.4\text{칸} \times 0.1\text{V/DIV} = 0.64\text{V}_{pp}$

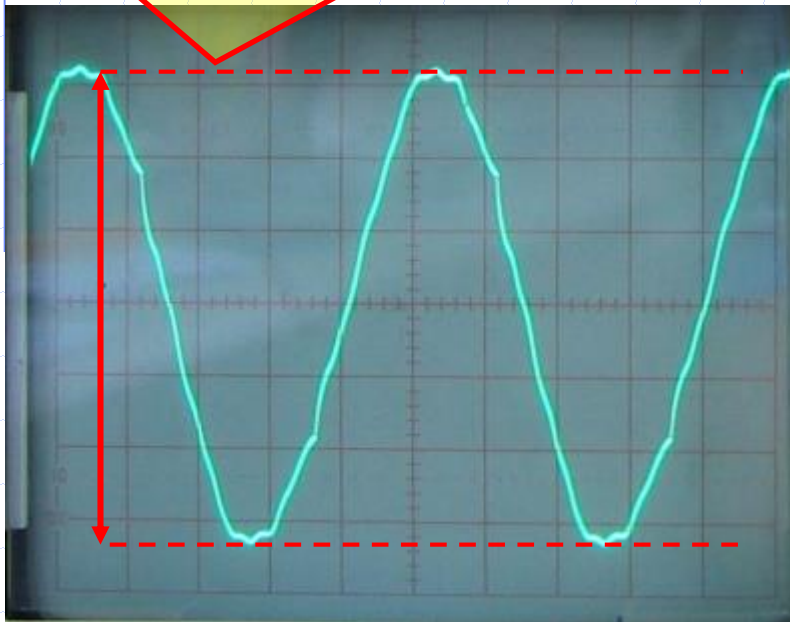

0.1V/DIV, 20uS/DIV

정현파
500Hz
10Vpp

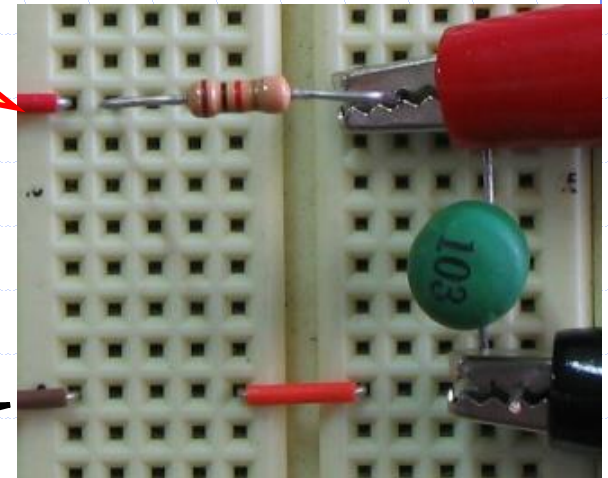

GND

$$X_L(\text{실험}) = \frac{V_L}{I} = \frac{0.64V_{PP}}{9.09mA_{PP}} = 70.41\Omega$$

$$|Z|(\text{실험}) = \frac{V_S}{I} = \frac{10V_{PP}}{9.09mA_{PP}} = 1100.11\Omega$$

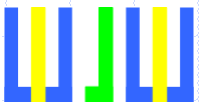

12-4. 주파수에 따른 임피던스

✓ 주파수 : 2kHz, 10Vpp

$$V_{R(rms)} = 3.156V$$

$$V_{R(p-p)} = 3.156V \times 2 \times 1.414 \\ = 8.925V_{pp}$$



$$V_L : 6\text{칸} \times 0.2V/DIV = 1.2V_{pp}$$

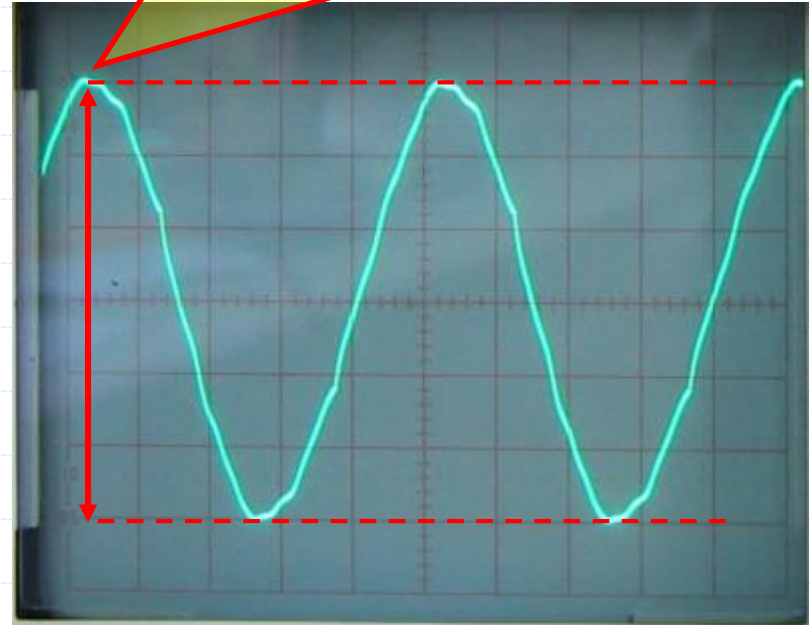

0.2V/DIV, 0.1mS/DIV

$$X_L(\text{실험}) = \frac{V_L}{I} = \frac{1.2V_{pp}}{8.925mA_{pp}} = 134.45\Omega$$

$$|Z|(\text{실험}) = \frac{V_S}{I} = \frac{10V_{pp}}{8.925mA_{pp}} = 1120.45\Omega$$

$$I_T(\text{실험}) = \frac{V_R}{R} = \frac{8.925V_{pp}}{1k\Omega} = 8.925mA_{pp}$$

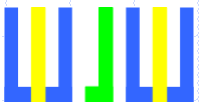

12-4. 주파수에 따른 임피던스

✓ 주파수 : 5kHz, 10Vpp

$$V_{R(rms)} = 2.939V$$

$$V_{R(p-p)} = 2.939V \times 2 \times 1.414$$

$$= 8.311V_{pp}$$



$$V_L : 5.7\text{칸} \times 0.5V/DIV = 2.85V_{pp}$$

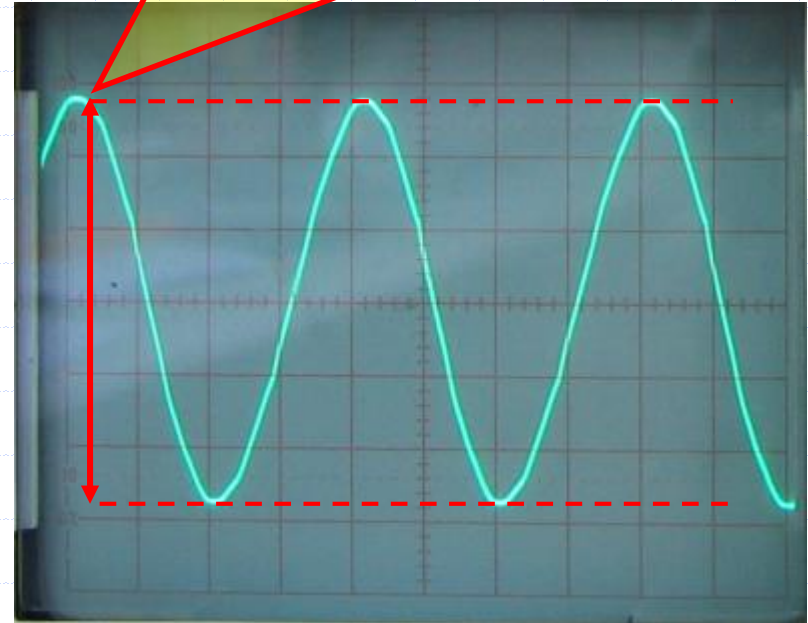

0.5V/DIV, 0.1mS/DIV

$$X_L(\text{실험}) = \frac{V_L}{I} = \frac{2.85V_{pp}}{8.311mA_{pp}} = 342.92\Omega$$

$$|Z|(\text{실험}) = \frac{V_S}{I} = \frac{10V_{pp}}{8.311mA_{pp}} = 1203.22\Omega$$

$$I_T(\text{실험}) = \frac{V_R}{R} = \frac{8.311V_{pp}}{1k\Omega} = 8.311mA_{pp}$$

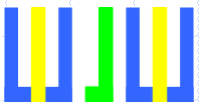

12-4. 주파수에 따른 임피던스

✓ 주파수 : 10kHz, 10Vpp

$$V_{R(rms)} = 2.47V$$

$$V_{R(p-p)} = 2.47V \times 2 \times 1.414$$

$$= 6.985V_{pp}$$



$$V_L : 4.9칸 \times 1V/DIV = 4.9V_{pp}$$

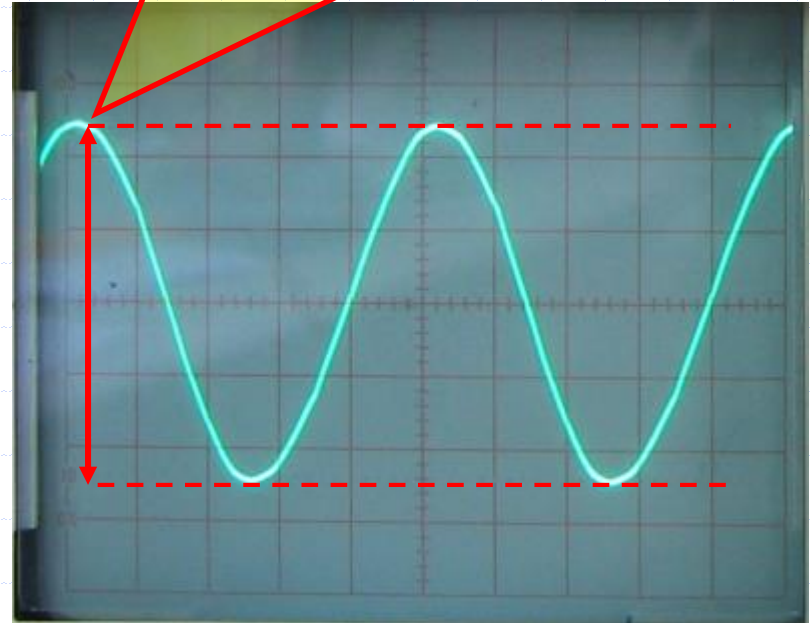

1V/DIV, 20uS/DIV

$$X_L(\text{실험}) = \frac{V_L}{I} = \frac{4.9V_{pp}}{6.985mA_{pp}} = 701.50\Omega$$

$$|Z|(\text{실험}) = \frac{V_S}{I} = \frac{10V_{pp}}{6.985mA_{pp}} = 1431.64\Omega$$

$$I_T(\text{실험}) = \frac{V_R}{R} = \frac{6.985V_{pp}}{1k\Omega} = 6.985mA_{pp}$$

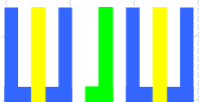

12-4. 주파수에 따른 임피던스

✓ 주파수 : 15kHz, 10Vpp

$$V_{R(rms)} = 2.074V$$

$$V_{R(p-p)} = 2.074V \times 2 \times 1.414$$

$$= 5.865V_{pp}$$



$$V_L : 6.5 \text{칸} \times 1V/DIV = 6.5V_{pp}$$

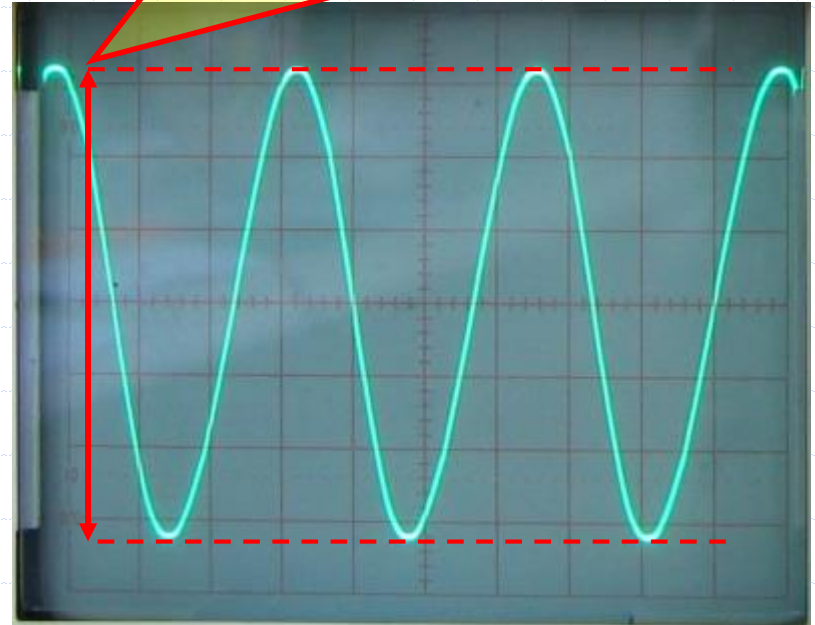

1V/DIV, 20uS/DIV

$$X_L(\text{실험}) = \frac{V_L}{I} = \frac{6.5V_{pp}}{5.865mA_{pp}} = 1108.27\Omega$$

$$|Z|(\text{실험}) = \frac{V_S}{I} = \frac{10V_{pp}}{5.865mA_{pp}} = 1705.03\Omega$$

$$I_T(\text{실험}) = \frac{V_R}{R} = \frac{5.865V_{pp}}{1k\Omega} = 5.865mA_{pp}$$

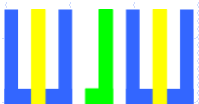

12-4. 주파수에 따른 임피던스

✓ 주파수 : 20kHz, 10Vpp

$$V_{R(rms)} = 1.793V$$

$$V_{R(p-p)} = 1.793V \times 2 \times 1.414$$

$$= 5.07V_{pp}$$



$$V_L : 7.7칸 \times 1V/DIV = 7.7V_{pp}$$

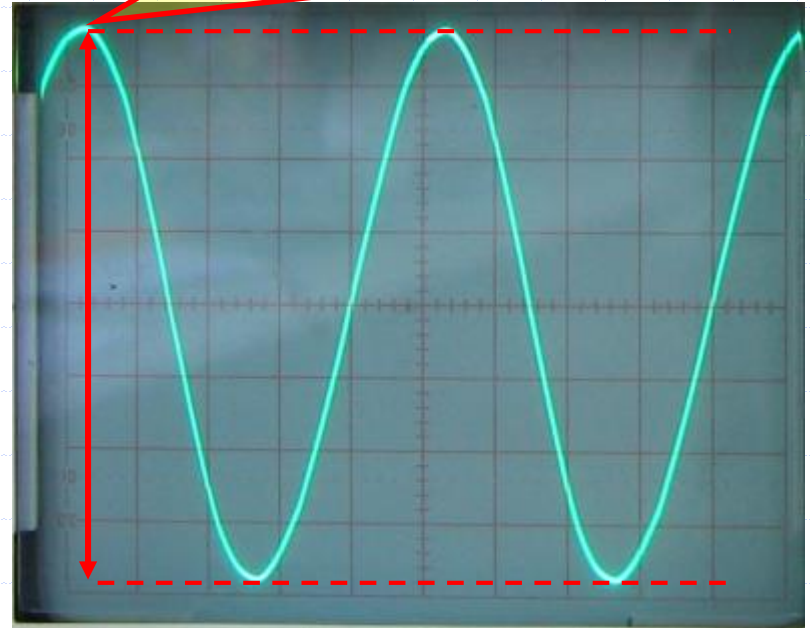

1V/DIV, 10uS/DIV

$$X_L(\text{실험}) = \frac{V_L}{I} = \frac{7.7V_{pp}}{5.07mA_{pp}} = 1518.74\Omega$$

$$|Z|(\text{실험}) = \frac{V_S}{I} = \frac{10V_{pp}}{5.07mA_{pp}} = 1972.39\Omega$$

$$I_T(\text{실험}) = \frac{V_R}{R} = \frac{5.07V_{pp}}{1k\Omega} = 5.07mA_{pp}$$

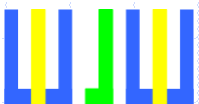

12-4. 주파수에 따른 임피던스

주파수	VR (Vpp)		VL (Vpp)		I (mA)		XL (Ω)		Z (Ω)	
	이론	실험	이론	실험	이론	실험	이론	실험	이론	실험
1,000	9.98	9.090	0.63	0.64	9.98	9.090	62.83	70.41	1001.97	1100.10
2,000	9.92	8.925	1.24	1.20	9.92	8.925	125.66	134.45	1007.86	1120.45
5,000	9.54	8.311	3.00	2.85	9.54	8.311	314.16	342.92	1048.19	1203.22
10,000	8.47	6.985	5.32	4.90	8.47	6.985	628.32	701.50	1181.01	1430.64
15,000	7.28	5.865	6.86	6.50	7.28	5.865	942.48	1108.27	1374.14	1705.03
20,000	6.23	5.070	7.82	7.70	6.23	5.070	1256.64	1518.74	1605.97	1972.39

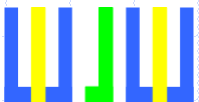

12-5. 위상의 변화

- 다음과 같이 회로를 연결하고, 신호 발생기를 조절하여 주파수 10kHz, 10Vpp 의 정현파가 나오도록 한다.

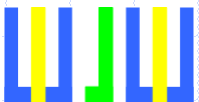
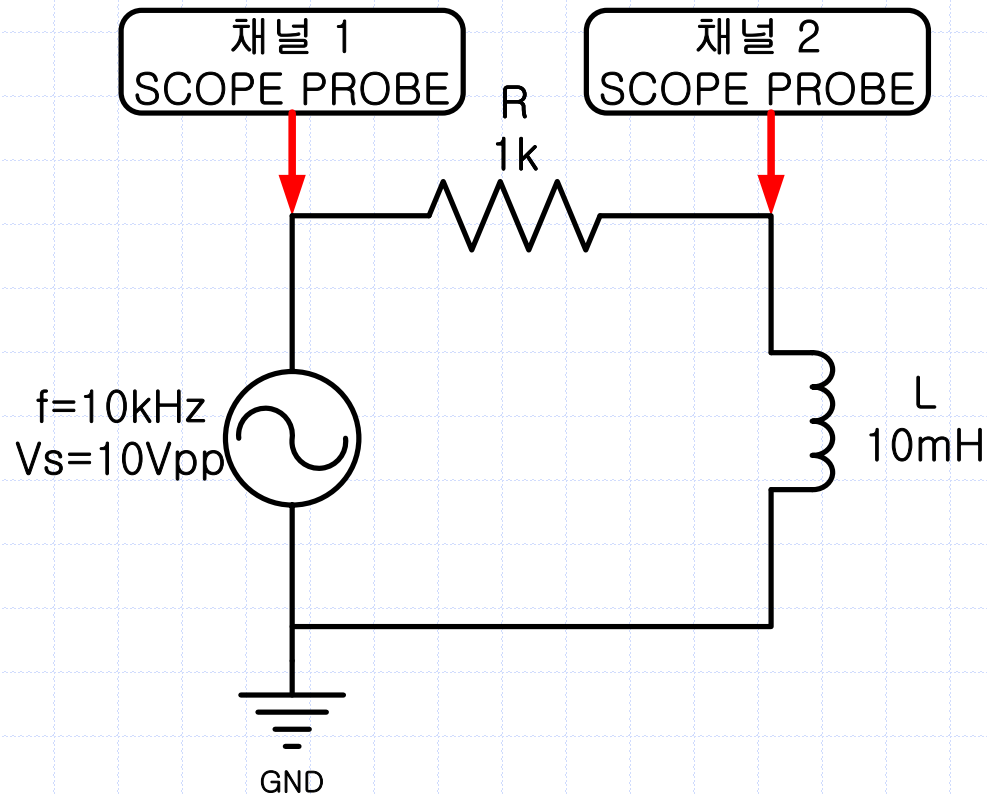

12-5. 위상의 변화

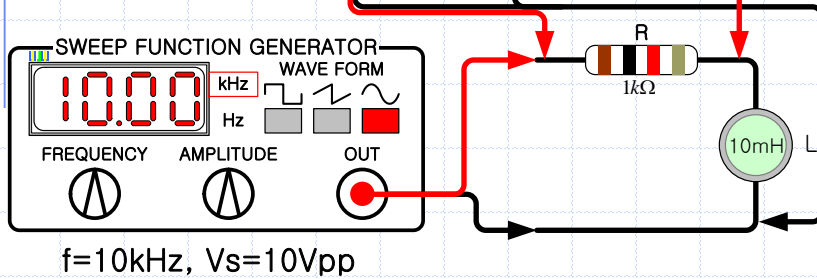
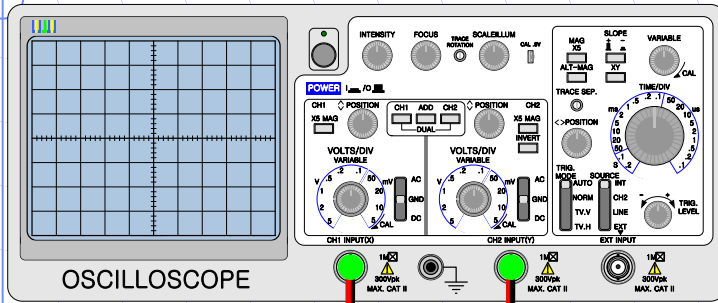

CH 1

CH 2

신호 발생기
Function Generator

정현파
10kHz
10Vpp

GND

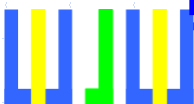
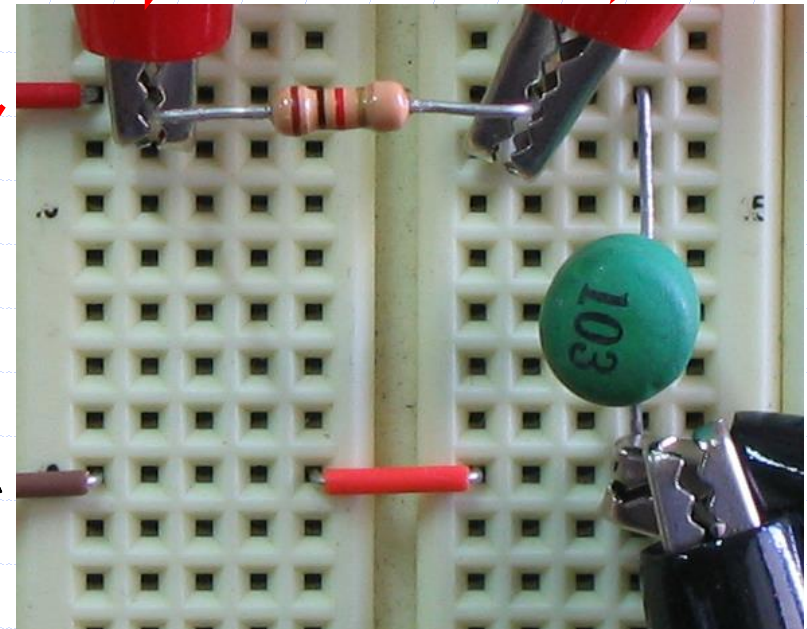

12-5. 위상의 변화

10kHz



10Vpp

CH 1 : 전압 파형

CH 2 : 전압 파형

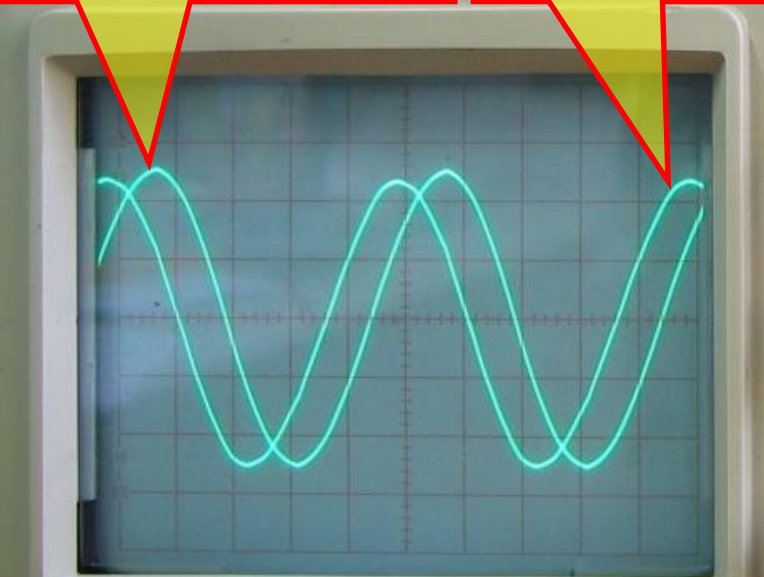

CH 1 : 2V/DIV, CH 2 : 1V/DIV
Time : 50uS/DIV

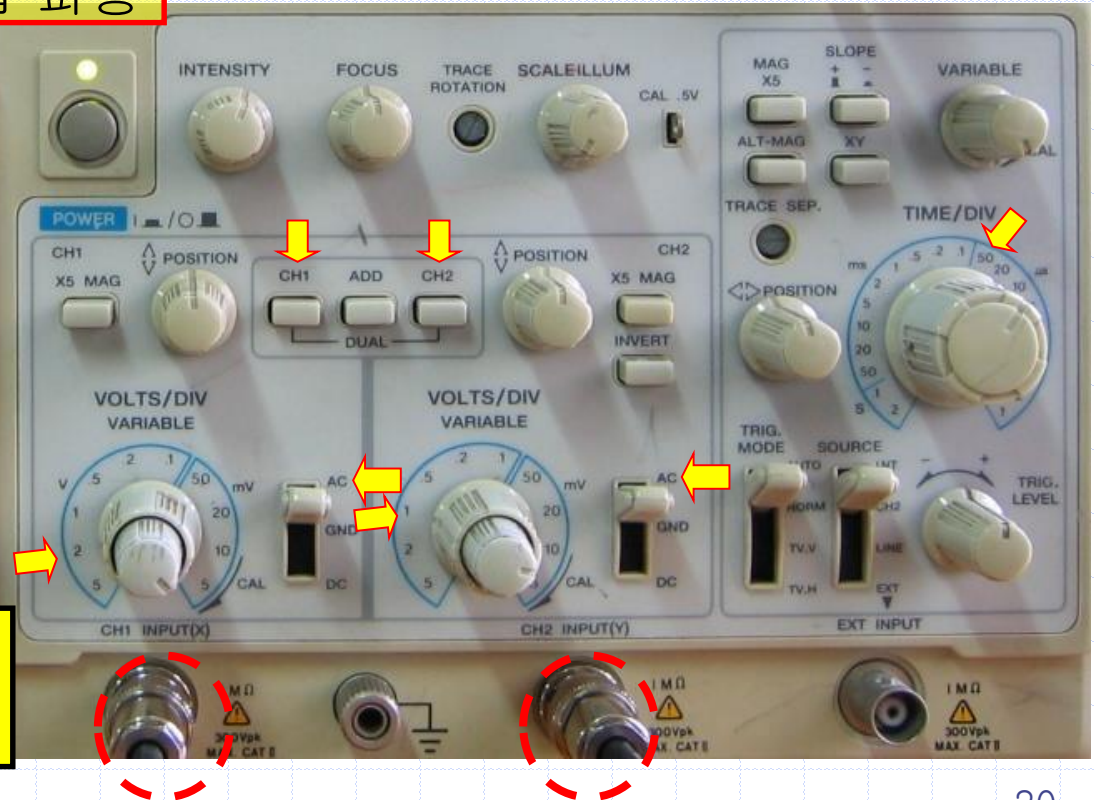

12-5. 위상의 변화

✓ 위상차를 측정하라. (주파수 : 10kHz)

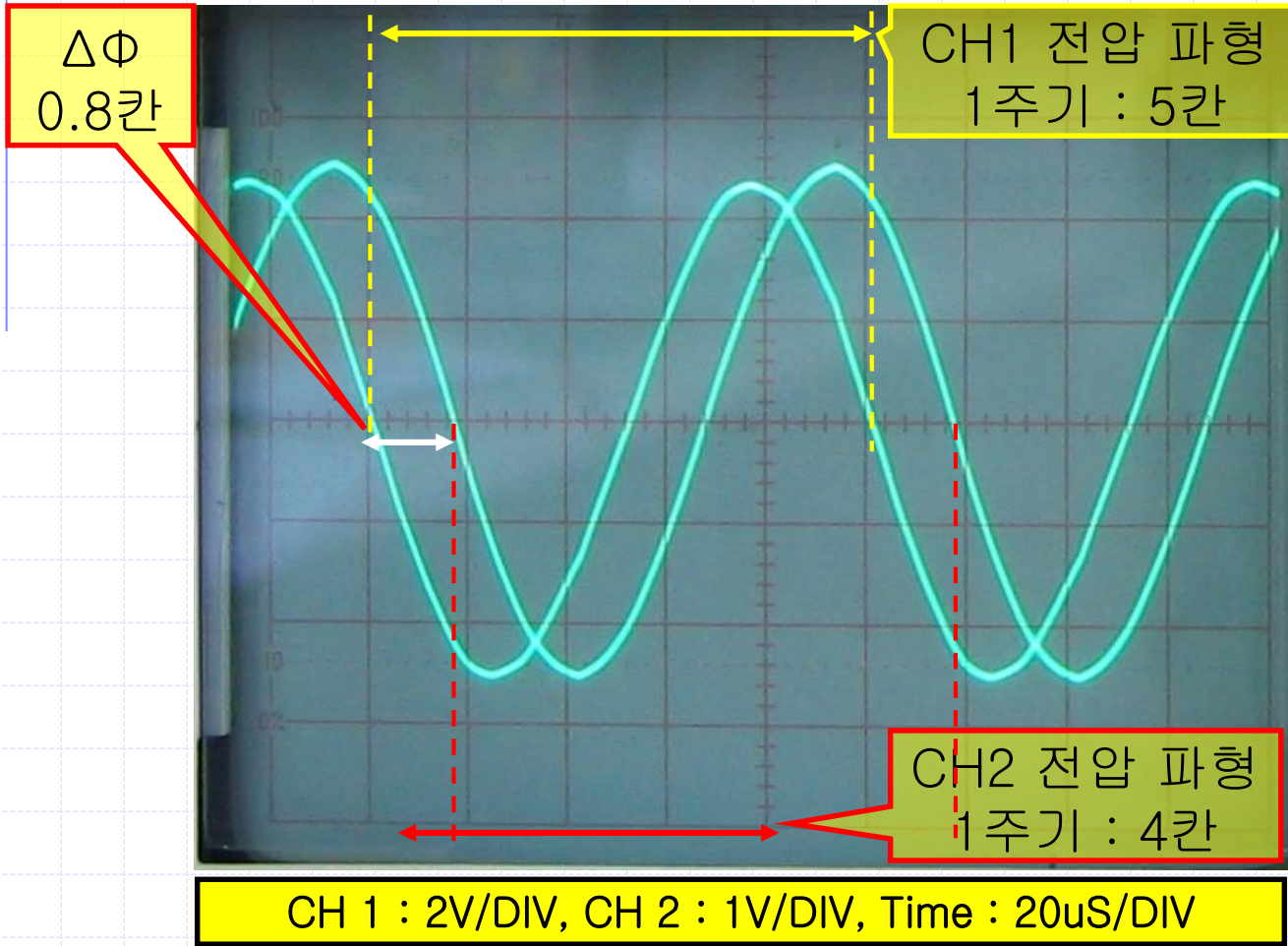

$$1T = 5\text{칸} \times 20\mu\text{Sec} = 100\mu\text{Sec}$$

$$\Delta t = 0.8\text{칸} \times 20\mu\text{Sec} = 16\mu\text{Sec}$$

$$100\mu\text{Sec} : 16\mu\text{Sec} = 360^\circ : \Delta\theta$$

$$\Delta\theta = 57.6^\circ$$

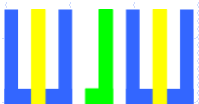

12-5. 위상의 변화

✓ 위상차를 측정하라. (주파수 : 15kHz)

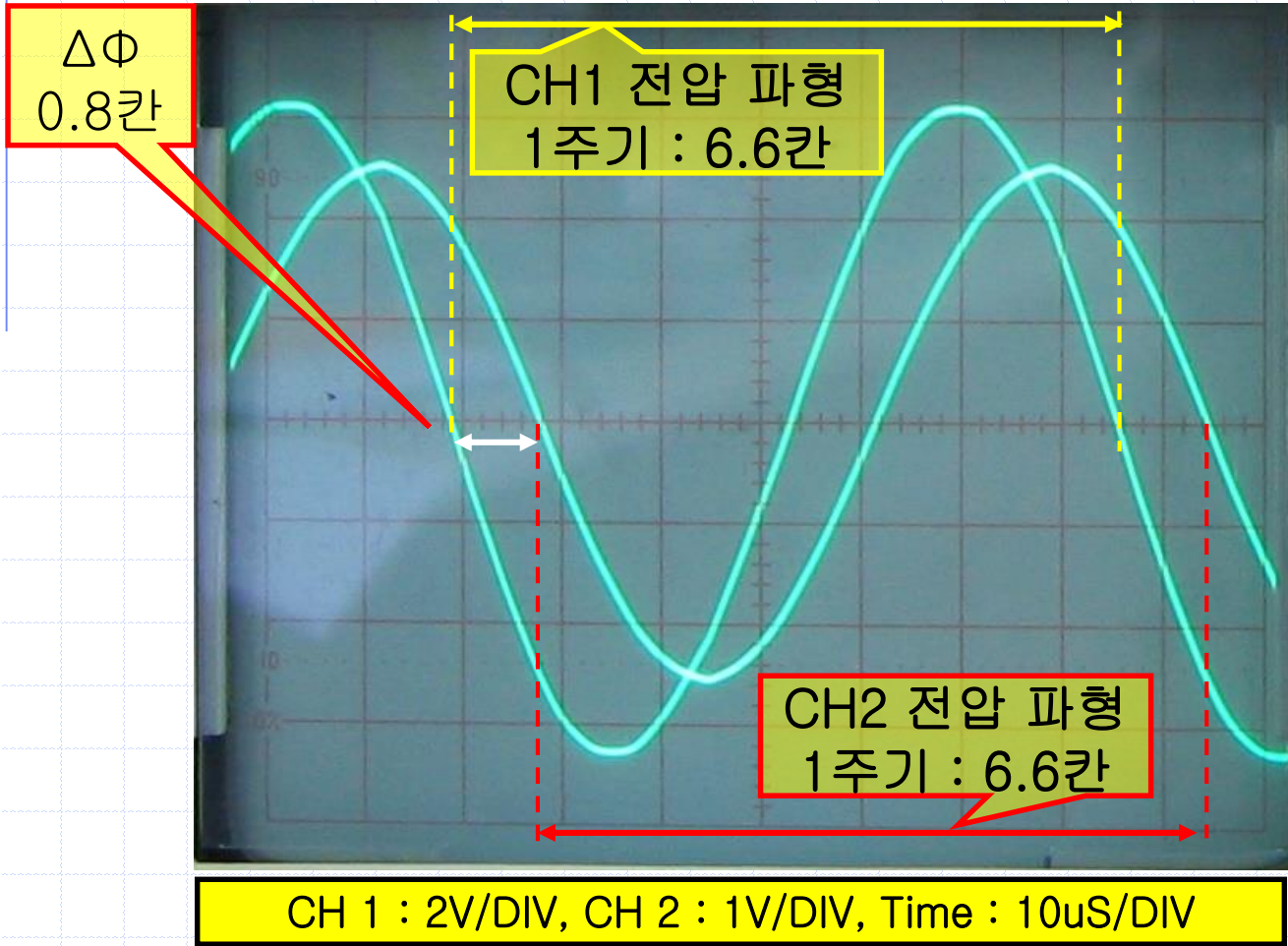

$$1T = 6.6\text{칸} \times 10\mu\text{Sec} = 66\mu\text{Sec}$$

$$\Delta t = 0.8\text{칸} \times 10\mu\text{Sec} = 8\mu\text{Sec}$$

$$66\mu\text{Sec} : 8\mu\text{Sec} = 360^\circ : \Delta\theta$$

$$\Delta\theta = 43.6^\circ$$

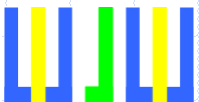

12-5. 위상의 변화

✓ 위상차를 측정하라. (주파수 : 20kHz)

$\Delta\phi$
0.5칸

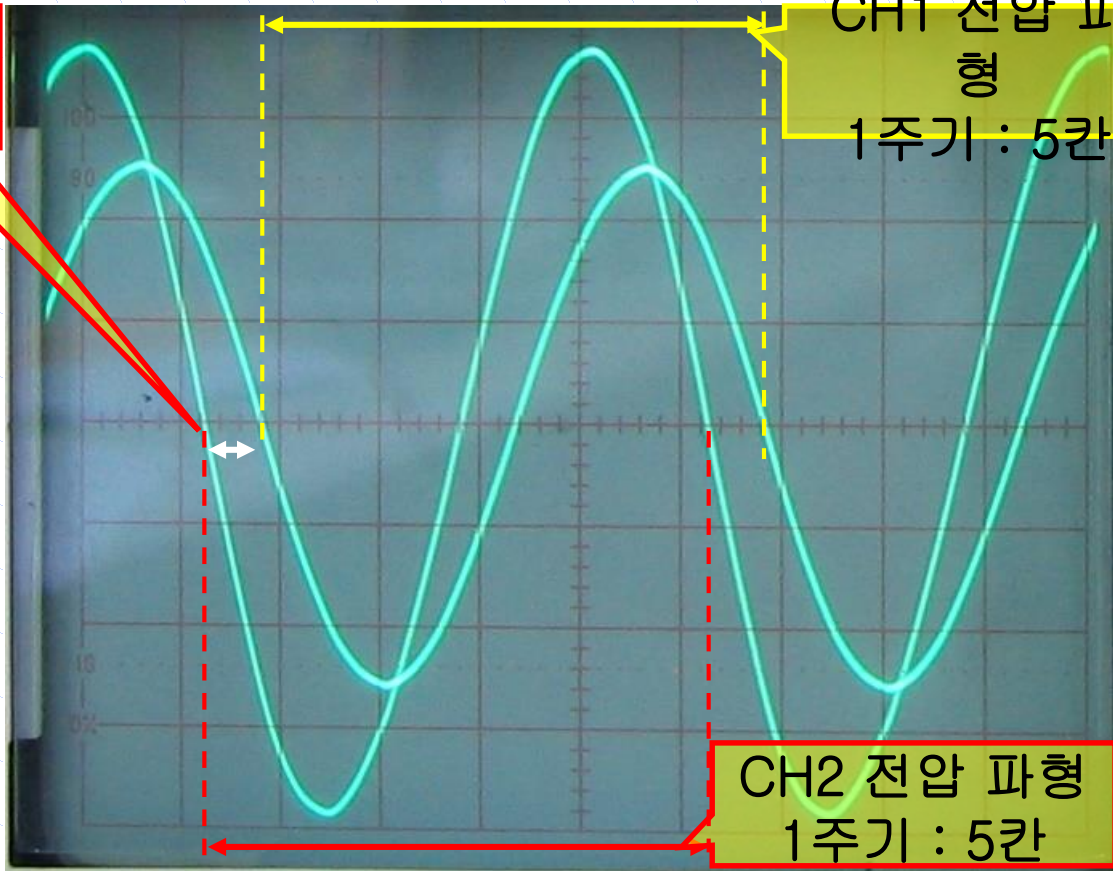

CH1 전압 파형
1주기 : 5칸

$$T = 5\text{칸} \times 10\mu\text{Sec} = 50\mu\text{Sec}$$

$$\Delta t = 0.5\text{칸} \times 10\mu\text{Sec} = 5\mu\text{Sec}$$

$$50\mu\text{Sec} : 5\mu\text{Sec} = 360^\circ : \Delta\theta$$

$$\Delta\theta = 36^\circ$$

CH2 전압 파형
1주기 : 5칸

CH 1 : 2V/DIV, CH 2 : 1V/DIV, Time : 10uS/DIV

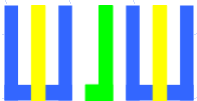

12-5. 위상의 변화

주파수	위상차 (도)		
	실험 9.	실험 10.	계산값
1 kHz		4.03	3.6
2 kHz		7.66	7.2
5 kHz		18.93	17.4
10 kHz	32.4	35.05	32.1
15 kHz	46.4	47.94	43.3
20 kHz	54.0	56.64	51.5

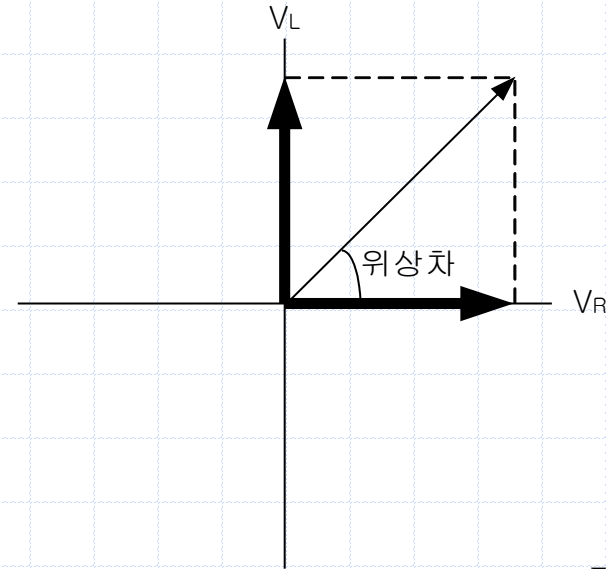

$$\text{위상차(실험10.)} = \tan^{-1}\left(\frac{V_L}{V_R}\right)$$

$$\text{위상차(계산값)} = \tan^{-1}\left(\frac{X_L}{R}\right)$$

$$X_L = \frac{1}{2\pi fL}$$

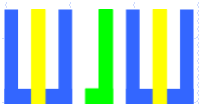

12-6. 전압과 전류의 위상

- 다음과 같이 회로를 연결하고, 신호 발생기를 조절하여 주파수 5kHz, 10Vpp 의 정현파가 나오도록 한다.

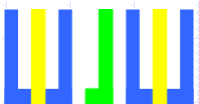
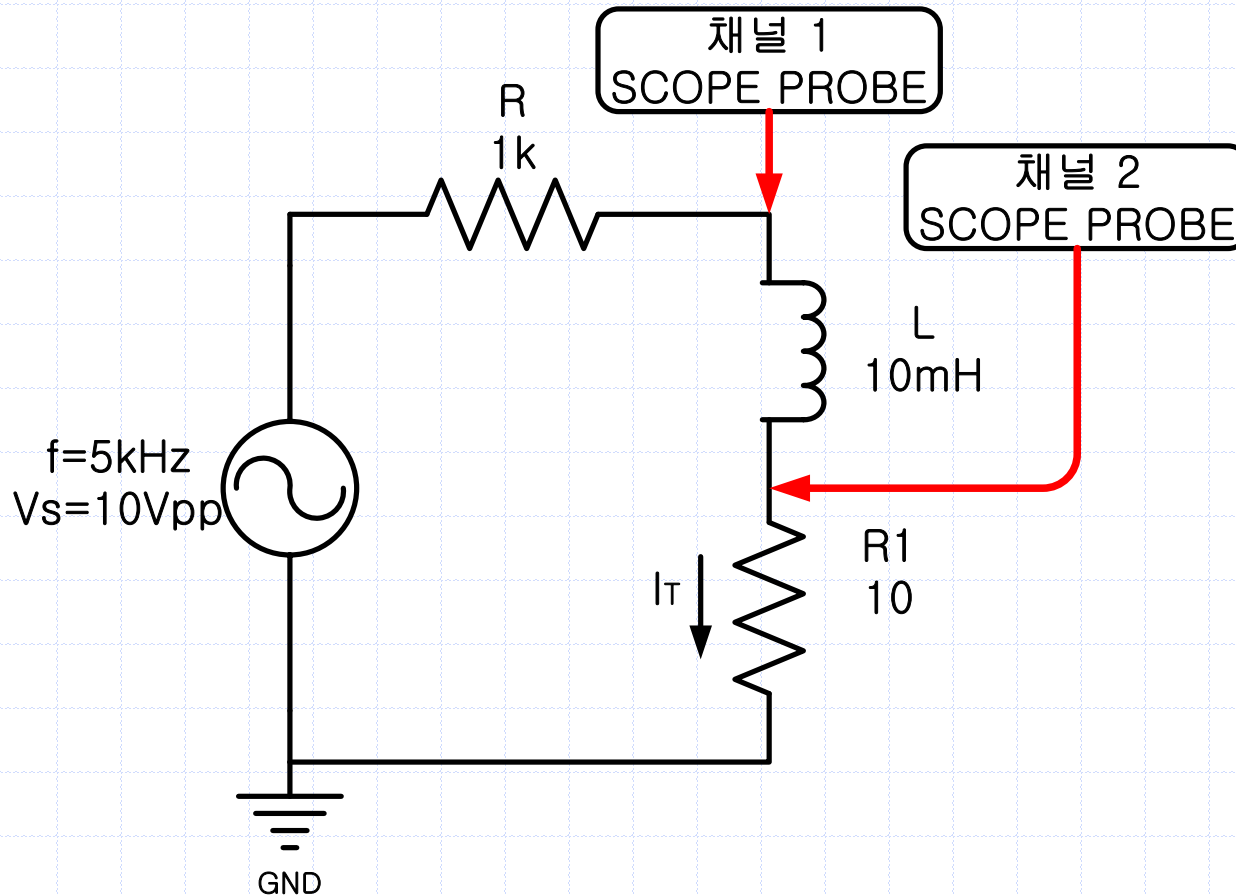

12-6. 전압과 전류의 위상

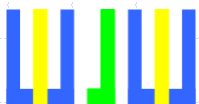
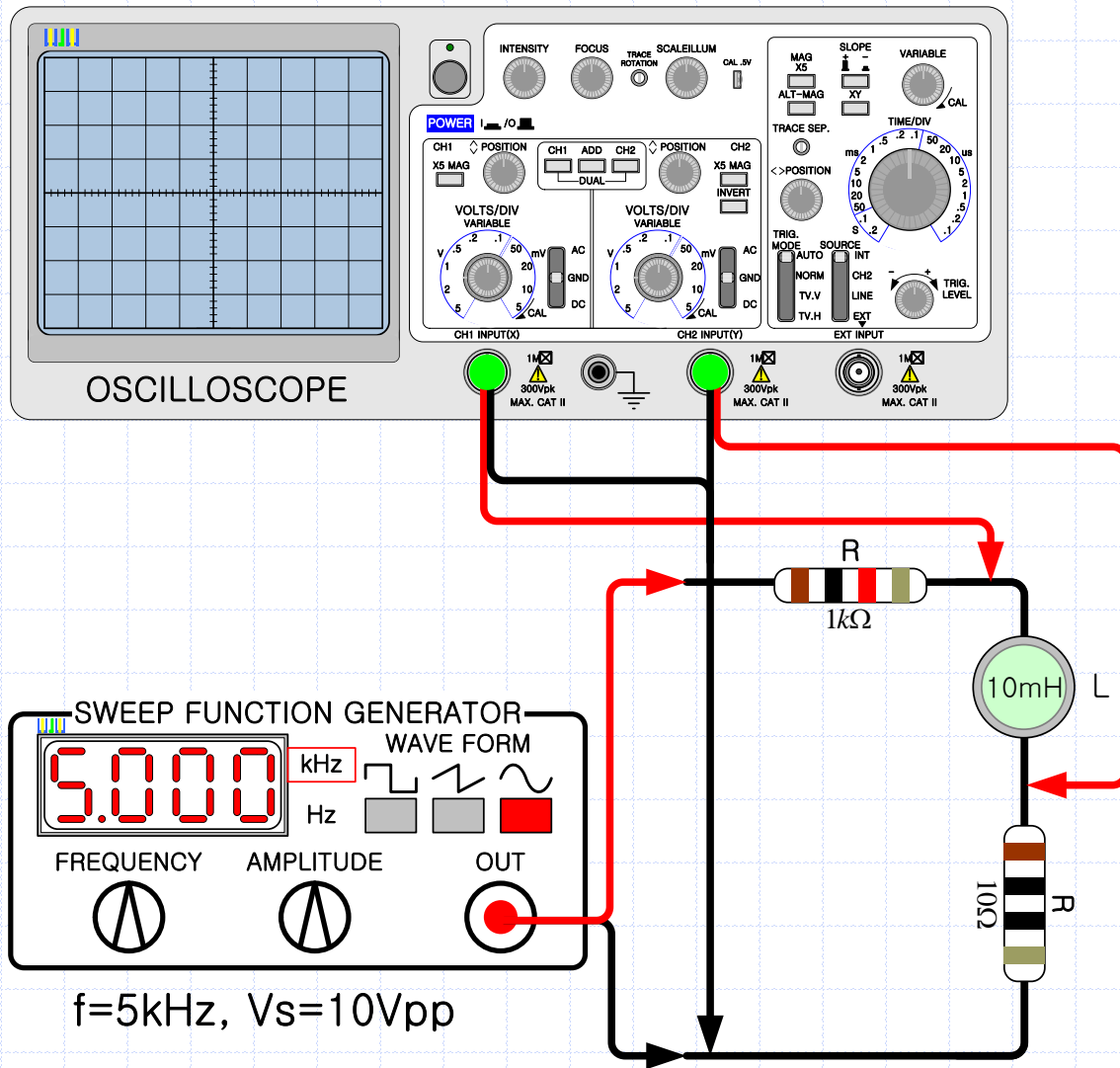

12-6. 전압과 전류의 위상

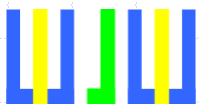
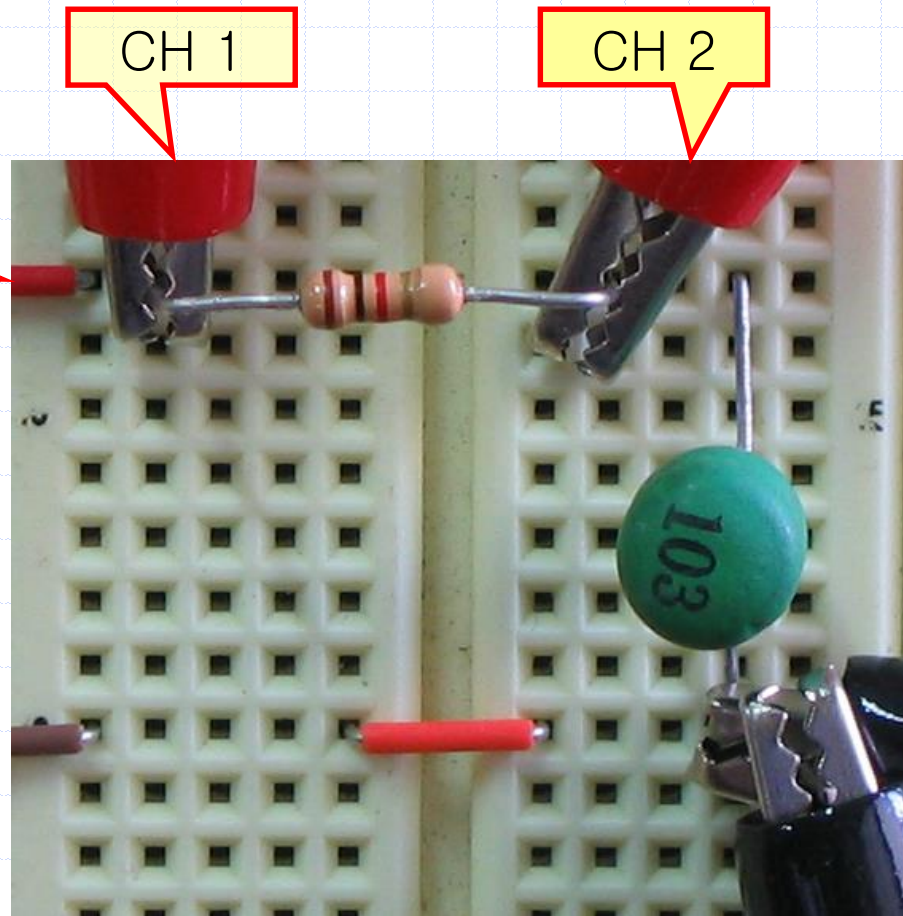
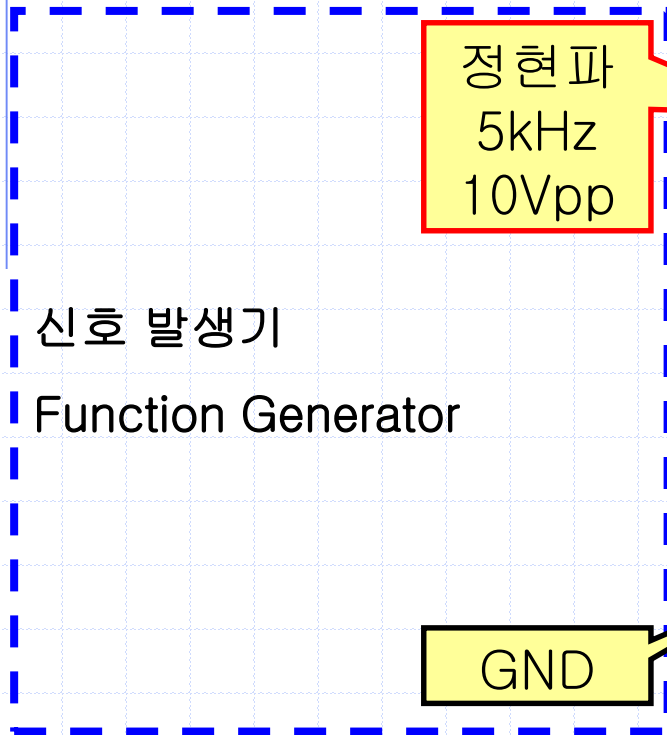

12-6. 전압과 전류의 위상

✓ 위상차를 측정하라. (주파수 : 5kHz)

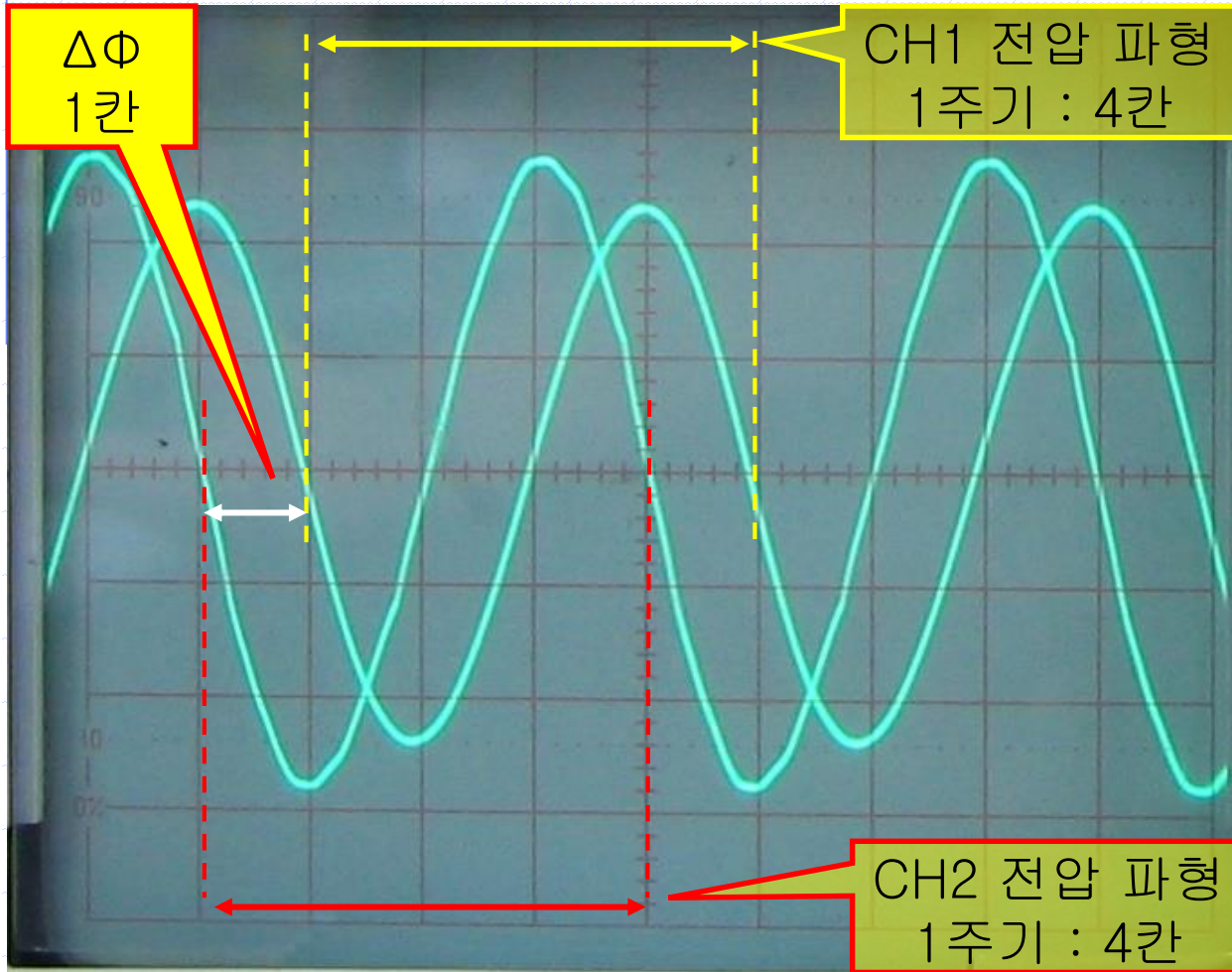

$$1T = 4\text{칸} \times 50\mu\text{Sec} = 200\mu\text{Sec}$$

$$\Delta t = 1\text{칸} \times 50\mu\text{Sec} = 50\mu\text{Sec}$$

$$200\mu\text{Sec} : 50\mu\text{Sec} = 360^\circ : \Delta\theta$$

$$\Delta\theta = 90^\circ$$

CH 1 : 0.5V/DIV, CH 2 : 20mV/DIV, Time : 50uS/DIV

12-6. 전압과 전류의 위상

✓ 위상차를 측정하라. (주파수 : 10kHz)

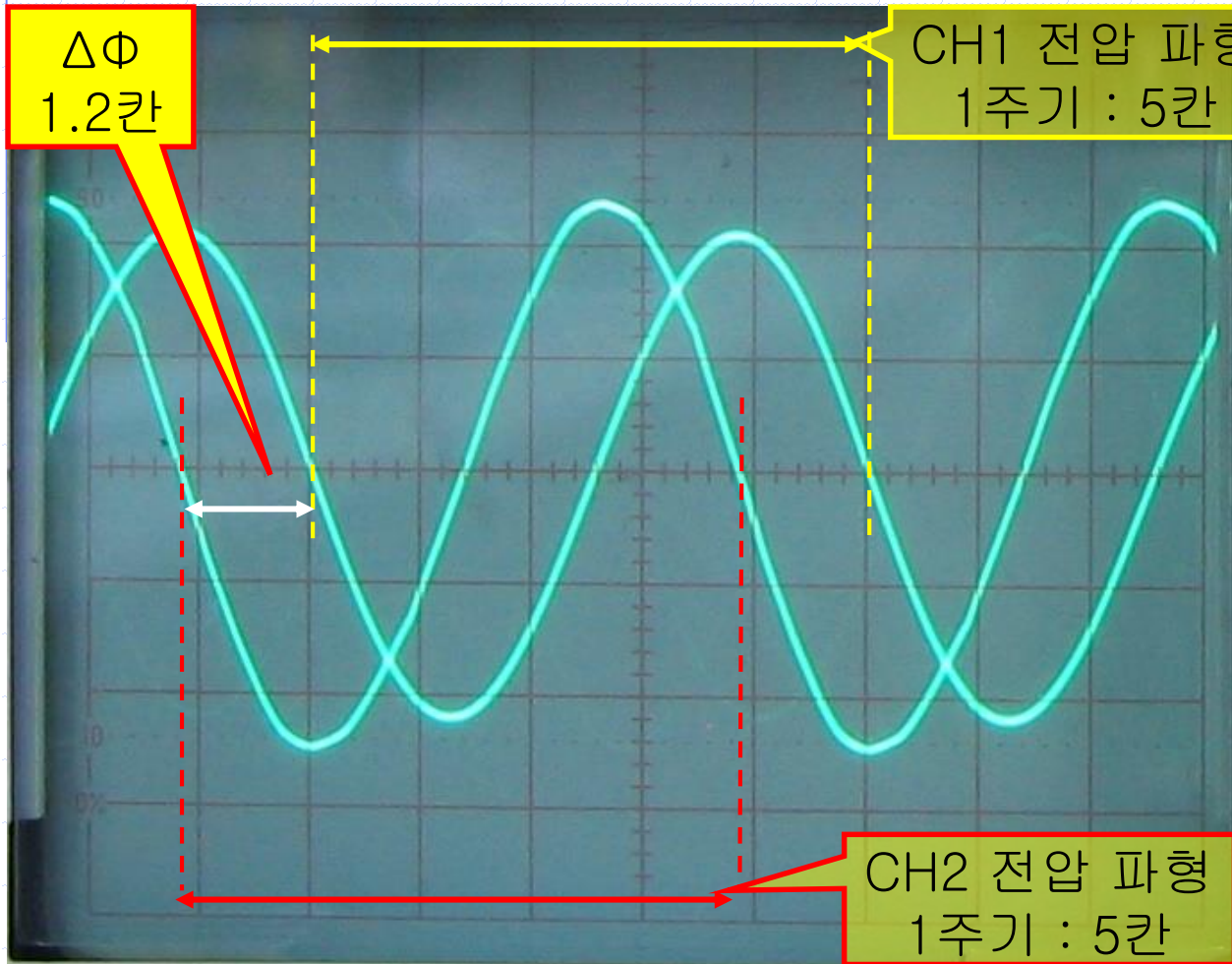

$$1T = 5\text{칸} \times 20\mu\text{Sec} = 100\mu\text{Sec}$$

$$\Delta t = 1.2\text{칸} \times 20\mu\text{Sec} = 24\mu\text{Sec}$$

$$100\mu\text{Sec} : 24\mu\text{Sec} = 360^\circ : \Delta\theta$$

$$\Delta\theta = 86.4^\circ$$

CH 1 : 1V/DIV, CH 2 : 10mV/DIV, Time : 20uS/DIV

12-6. 전압과 전류의 위상

✓ 위상차를 측정하라. (주파수 : 15kHz)

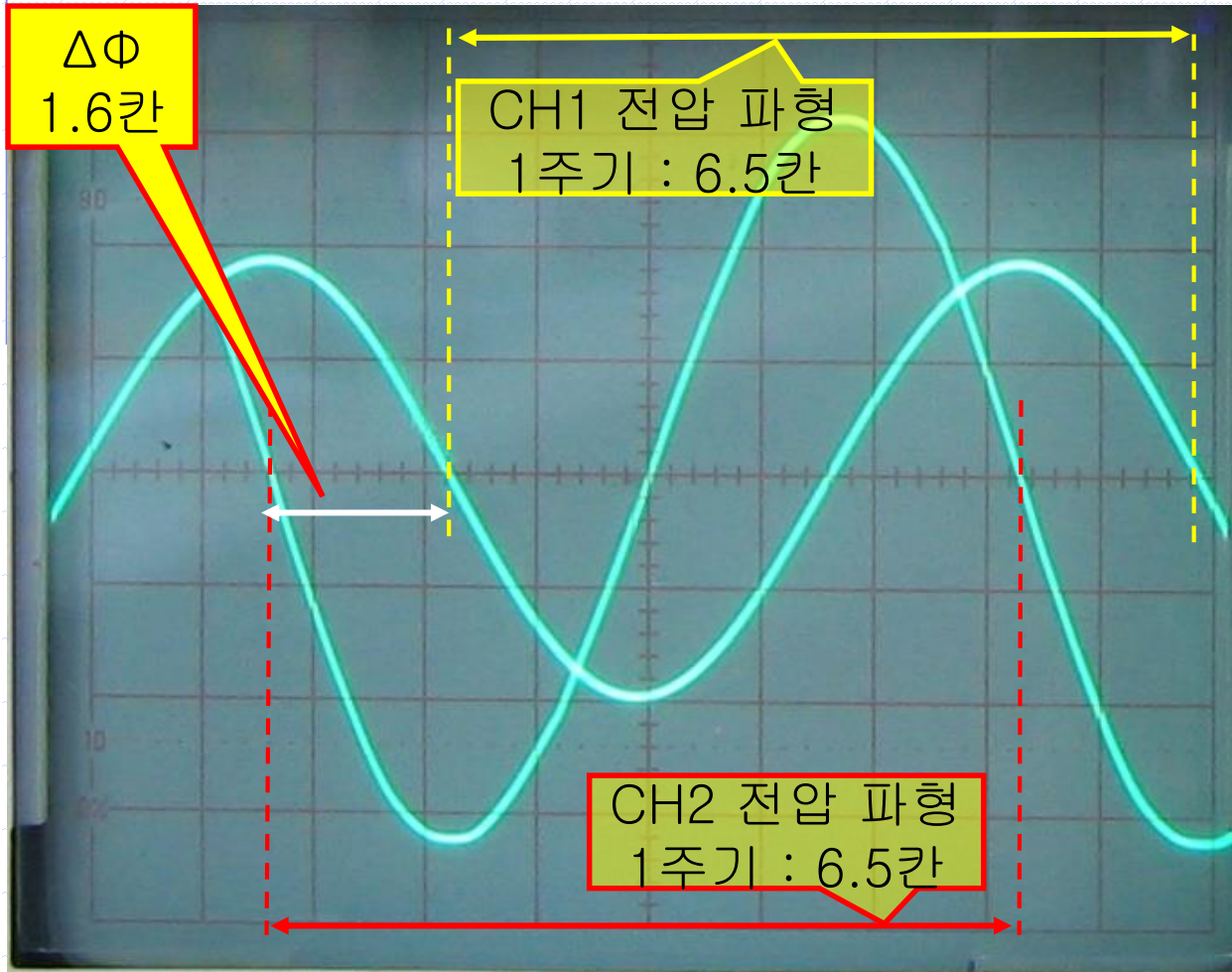

$$1T = 6.5\text{칸} \times 10\mu\text{Sec} = 65\mu\text{Sec}$$

$$\Delta t = 1.6\text{칸} \times 10\mu\text{Sec} = 1.6\mu\text{Sec}$$

$$65\mu\text{Sec} : 1.6\mu\text{Sec} = 360^\circ : \Delta\theta$$

$$\Delta\theta = 88.62^\circ$$

CH 1 : 1V/DIV, CH 2 : 10mV/DIV, Time : 10uS/DIV

12-6. 전압과 전류의 위상

✓ 위상차를 측정하라. (주파수 : 20kHz)



$$1T = 5\text{칸} \times 10\mu\text{Sec} = 50\mu\text{Sec}$$

$$\Delta t = 1.2\text{칸} \times 10\mu\text{Sec} = 12\mu\text{Sec}$$

$$50\mu\text{Sec} : 12\mu\text{Sec} = 360^\circ : \Delta\theta$$

$$\Delta\theta = 86.4^\circ$$

CH 1 : 1V/DIV, CH 2 : 10mV/DIV, Time : 10uS/DIV

12-6. 전압과 전류의 위상

주파수	실험 9.	계산값
5 kHz	90 도	90 도
10 kHz	86.4 도	90 도
15 kHz	88.62 도	90 도
20 kHz	86.4 도	90 도

