

회로 이론/실습

16. 수동 필터

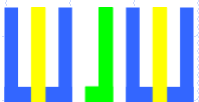

16. 수동 필터

16-1. 목적 및 배경

16-2. 소요 부품 및 장비

16-3. 유용한 공식

LPF, HPF, BPF, BRN (BSF)

16-4. RC Low Pass Filter

16-5. RL Low Pass Filter

16-6. RC High Pass Filter

16-7. RL High Pass Filter

16-8. Band Pass Filter

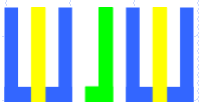

16-1. 목적 및 배경

- ✓ 필터의 종류와 특성을 이해한다.
- ✓ RC, RL 구조의 LPF 의 특성을 이해한다.
- ✓ RC, RL 구조의 HPF 의 특성을 이해한다.
- ✓ BPF 의 특성을 이해한다.

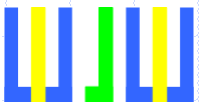

16-2. 소요 부품 및 장비

✓ 부품

- ✓ 저항 (1/4W) : $1\text{k}\Omega$
- ✓ 캐패시터 : $0.1\mu\text{F}$, $0.0022\mu\text{F}$
- ✓ 인덕터 : 1mH , 10mH

✓ 장비

- ✓ 브레드 보드
- ✓ 디지털 멀티미터 (Digital Multi-Meter)
- ✓ 오실로스코프 (Oscilloscope)
- ✓ 신호 발생기 (Function Generator)

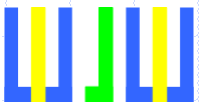

16-3. 유용한 공식

✓ LPF (Low Pass Filter) : 저역 통과 필터

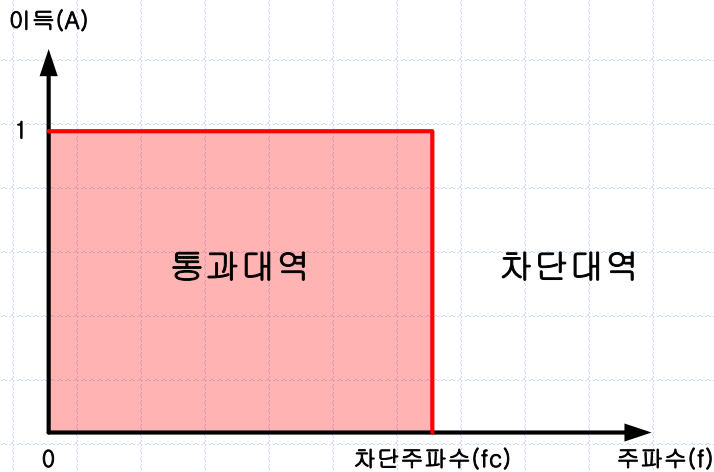

이상적인 Low Pass Filter (LPF)

차단 주파수 이하는 통과

차단 주파수 이상은 차단

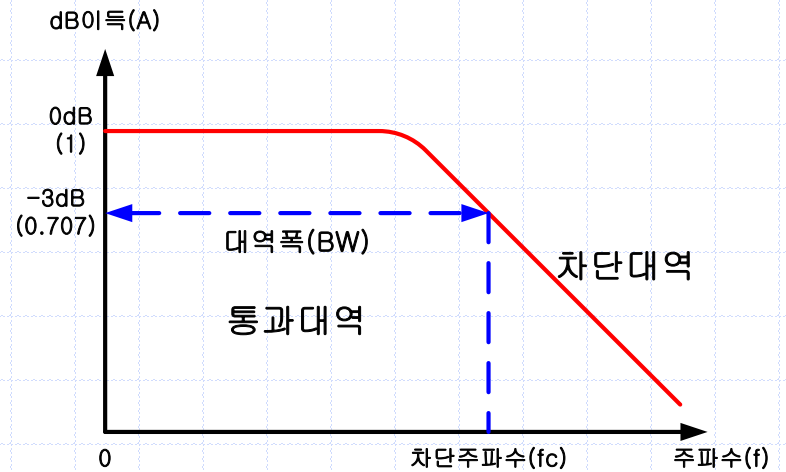

실제 Low Pass Filter (LPF)

최대 크기의 -3dB (0.707) 지점을

통과 대역으로 인정

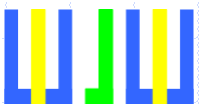

16-3. 유용한 공식

✓ HPF (High Pass Filter) : 고역 통과 필터

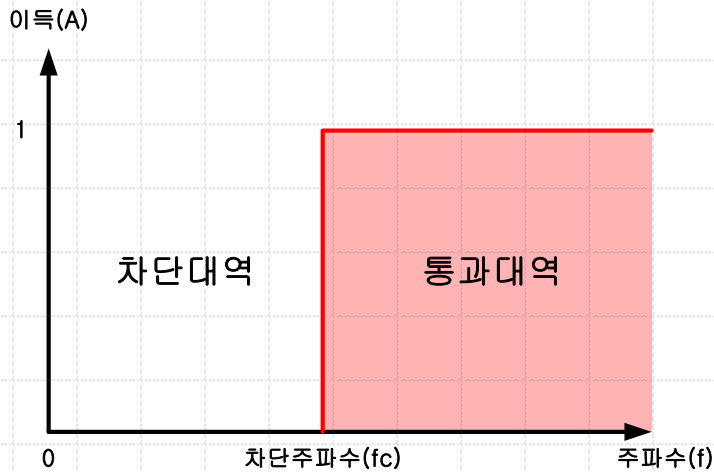

이상적인 High Pass Filter (HPF)

차단 주파수 이상은 통과

차단 주파수 이하는 차단

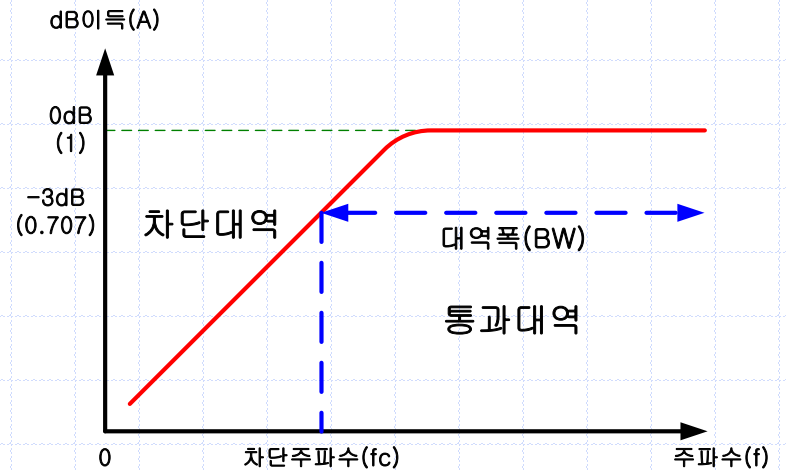

실제 High Pass Filter (HPF)

최대 크기의 -3dB (0.707) 지점을

통과 대역으로 인정

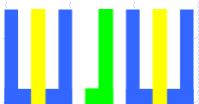

16-3. 유용한 공식

✓ BPF (Band Pass Filter) : 대역 통과 필터

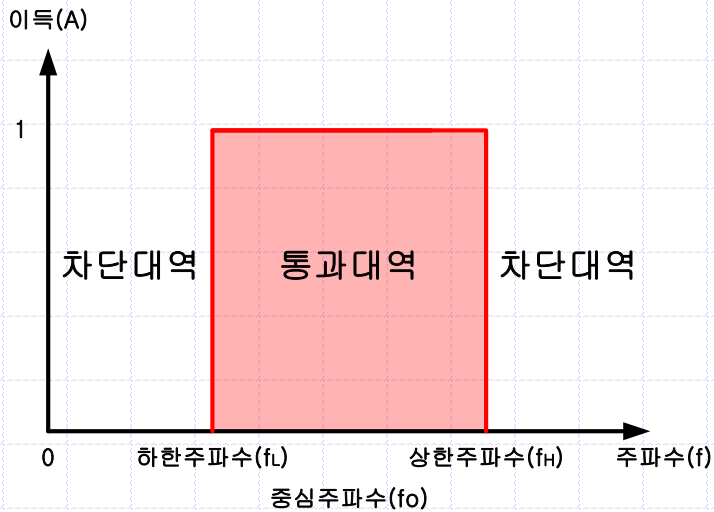

이상적인 Band Pass Filter (BPF)
하한과 상한 주파수 사이는 통과
그 외의 주파수는 차단

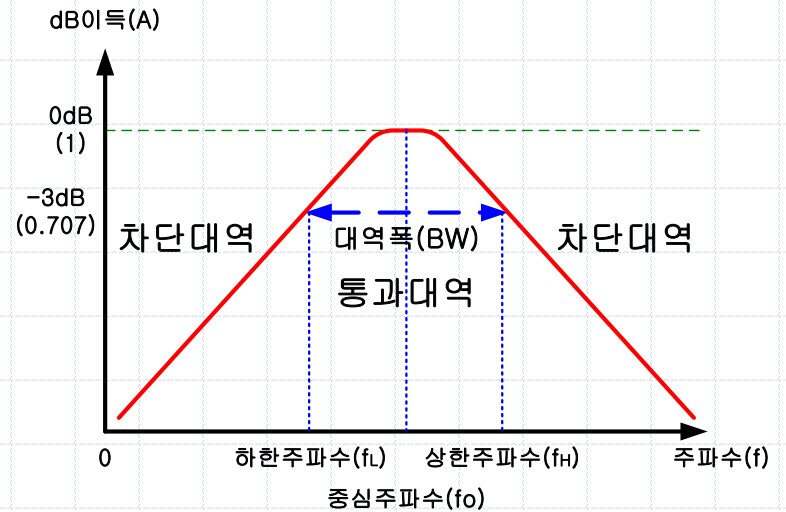

실제 Band Pass Filter (BPF)
최대 크기의 -3dB (0.707) 지점을
통과 대역으로 인정

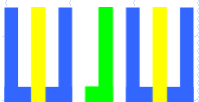

16-3. 유용한 공식

✓ BRF(Band Reject Filter)

BSF(Band Stop Filter) : 대역 차단 필터

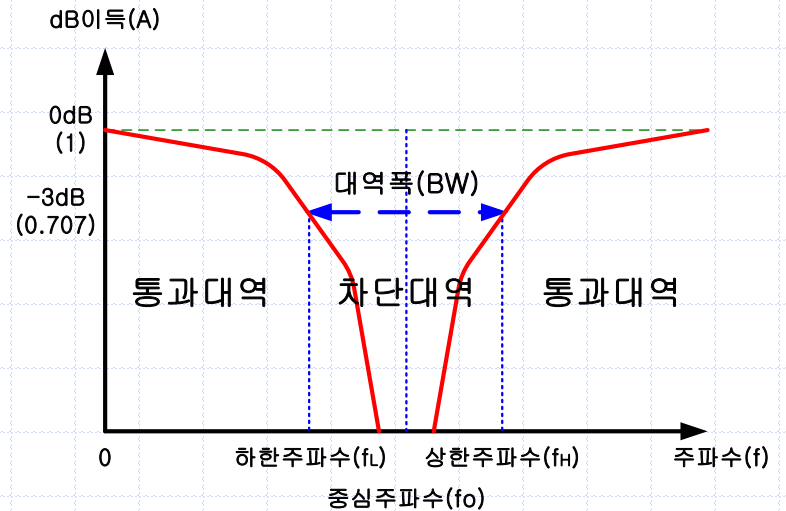
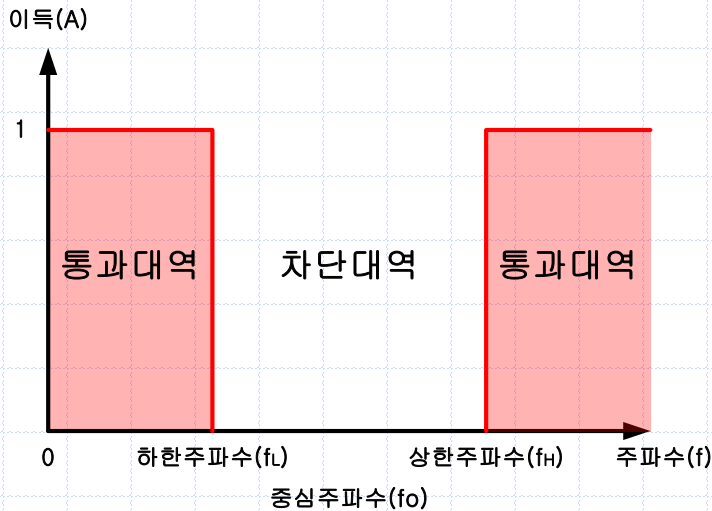

이상적인 Band Reject Filter (BRF) 실제 Band Reject Filter (BRF)

하한과 상한 주파수 사이는 차단

최대 크기의 -3dB (0.707) 지점을

그 외의 주파수는 통과

차단 대역으로 인정

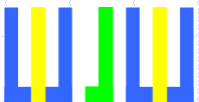

16-4. RC Low Pass Filter-LPF

- 다음과 같이 회로를 연결하고, 신호발생기를 조절하여 주파수 500Hz, 10Vpp 의 정현파가 나오도록 한다.

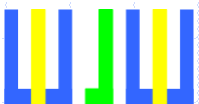
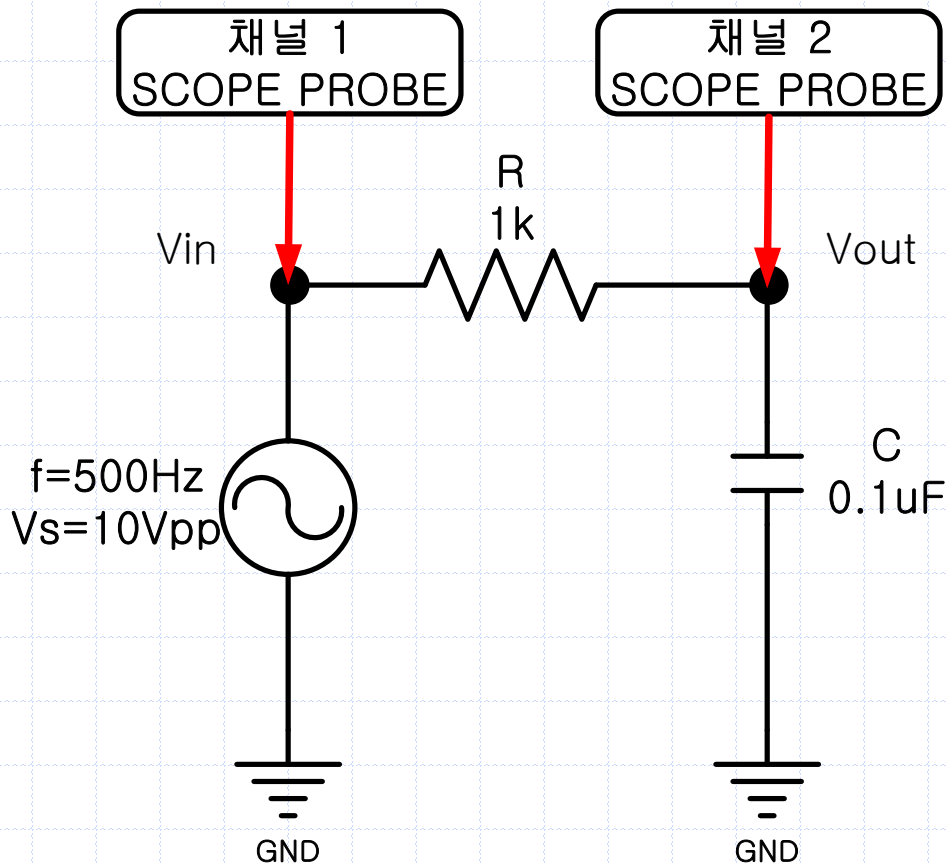

16-4. RC Low Pass Filter-LPF

- ✓ 다음과 같이 회로를 연결하고, 신호발생기를 조절하여 주파수 500Hz, 10Vpp 의 정현파가 나오도록 한다.

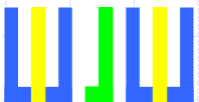
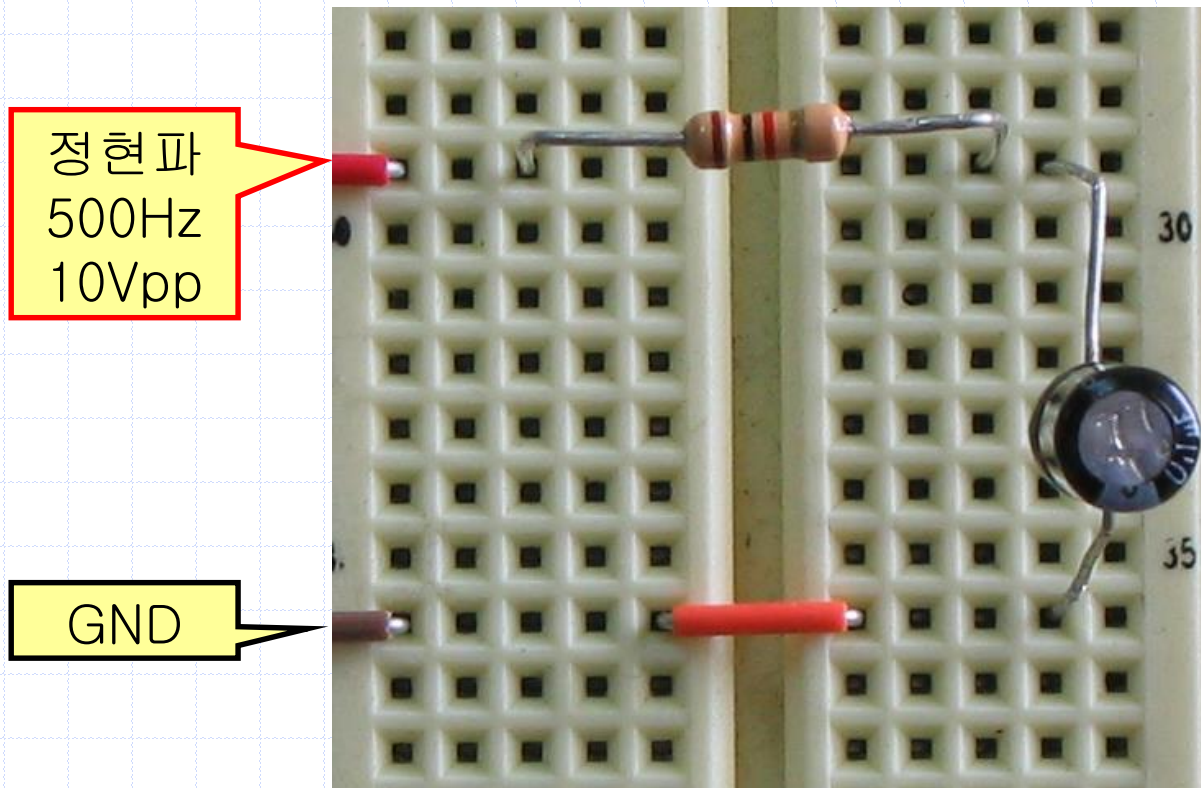

16-4. RC Low Pass Filter-LPF

- ✓ 오실로스코프의 CH 1 을 이용하여 입력 전압(V_{in})을 측정하고, CH 2는 출력 전압(V_{out})을 측정한다.

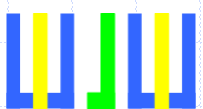
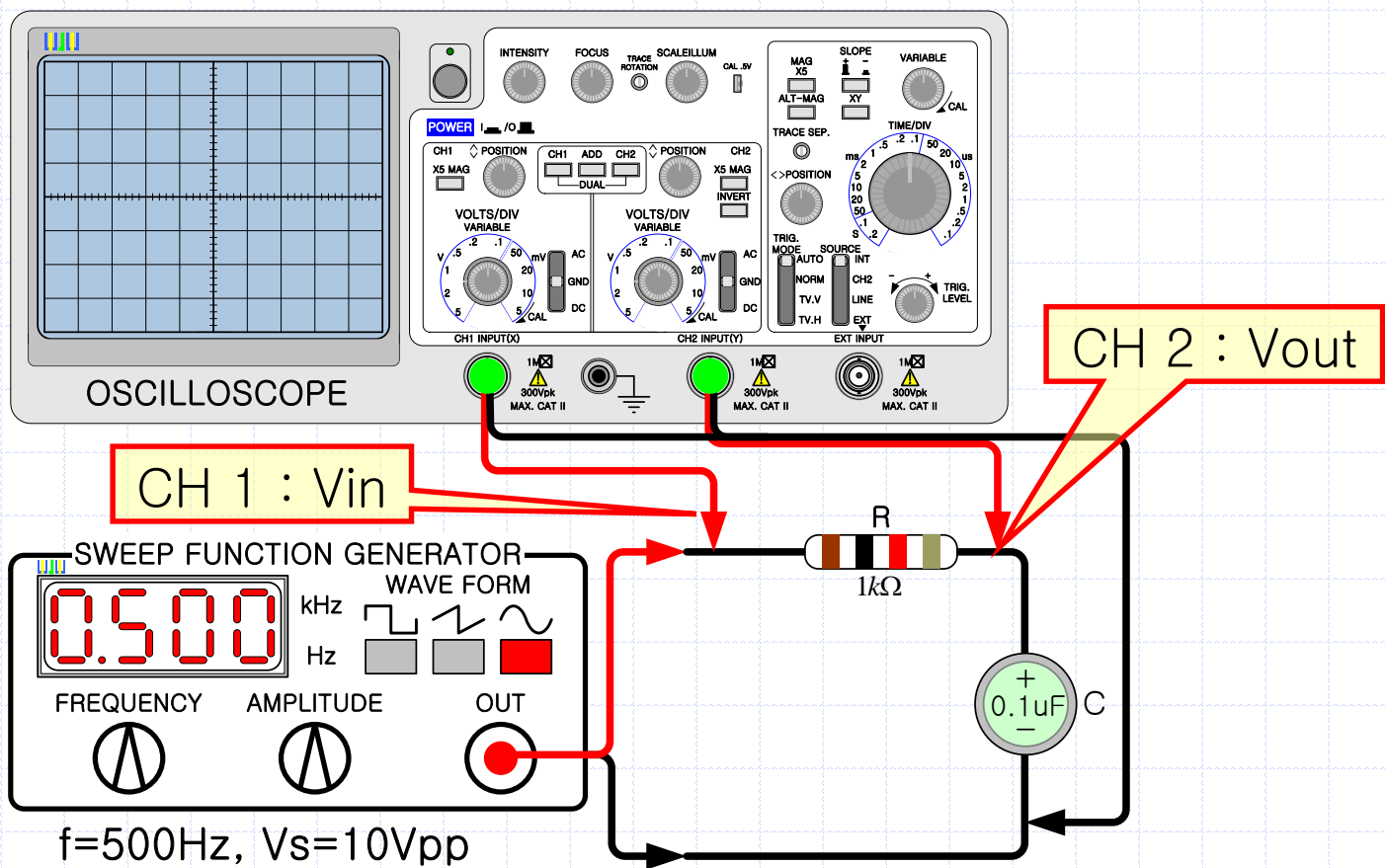

16-4. RC Low Pass Filter-LPF

✓ 주파수 : 500Hz

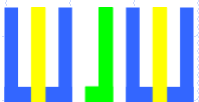
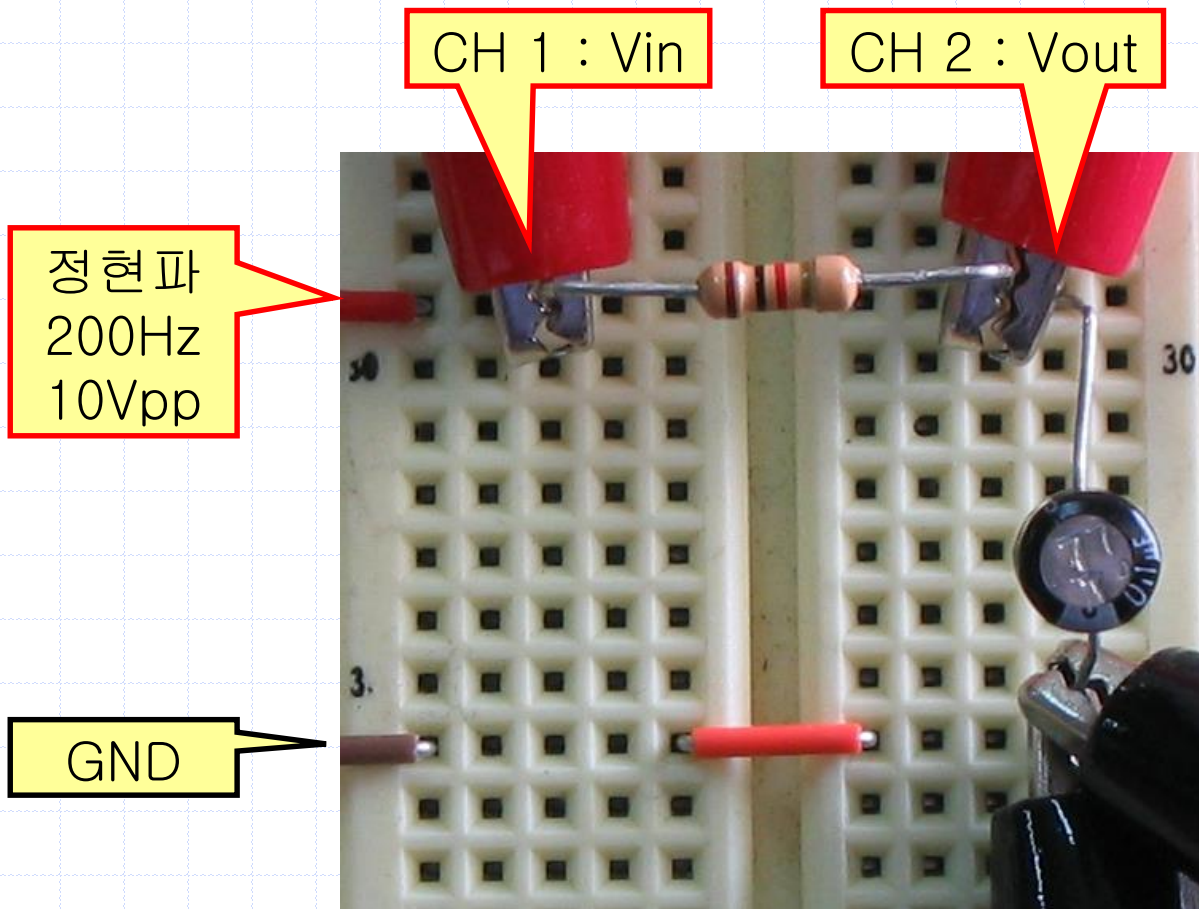

16-4. RC Low Pass Filter-LPF

✓ 주파수 : 500Hz

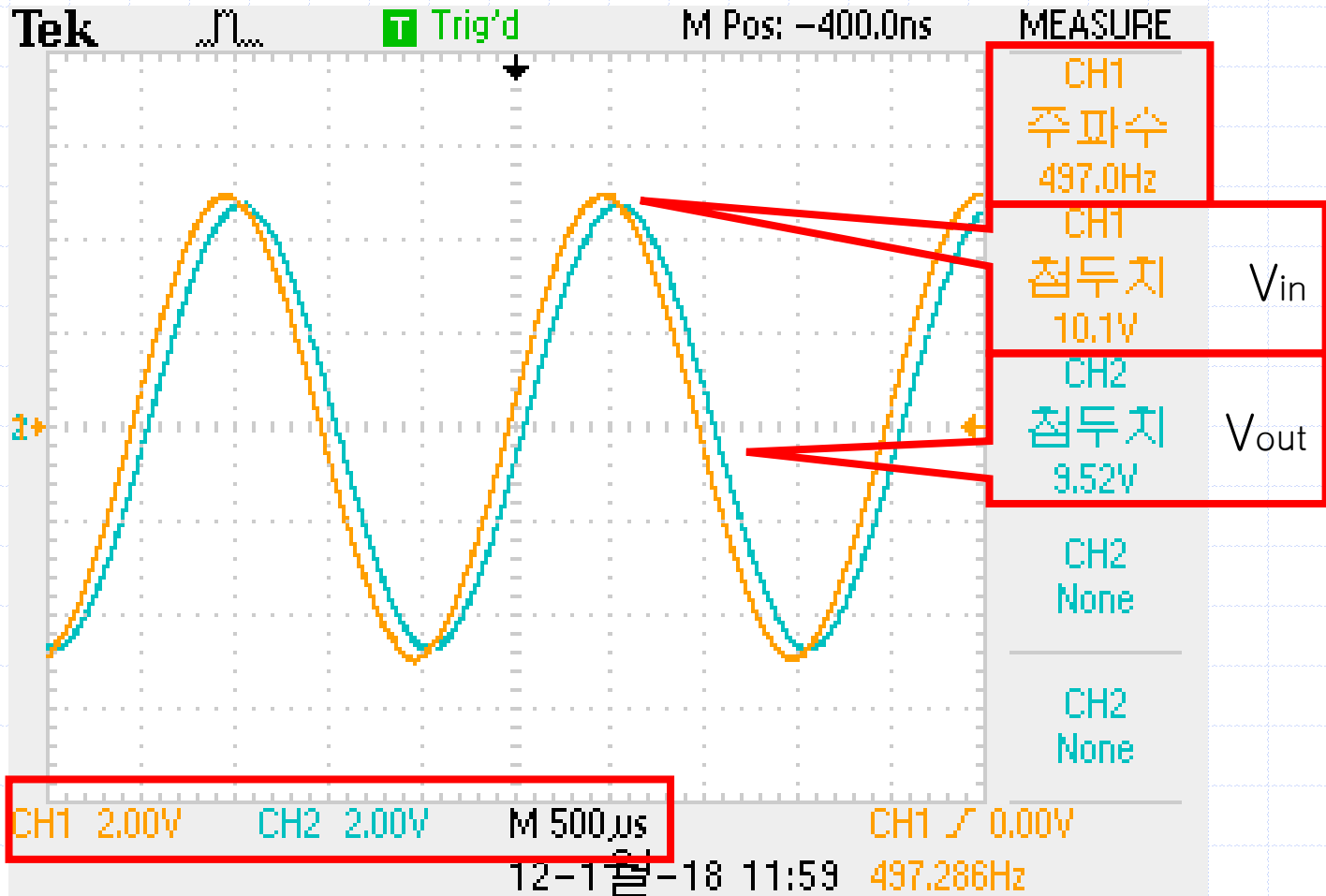

CH 1 : 2V/DIV, CH 2 : 2V/DIV, Time : 500uS/DIV

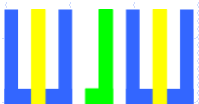

16-4. RC Low Pass Filter-LPF

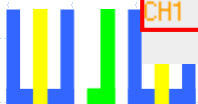
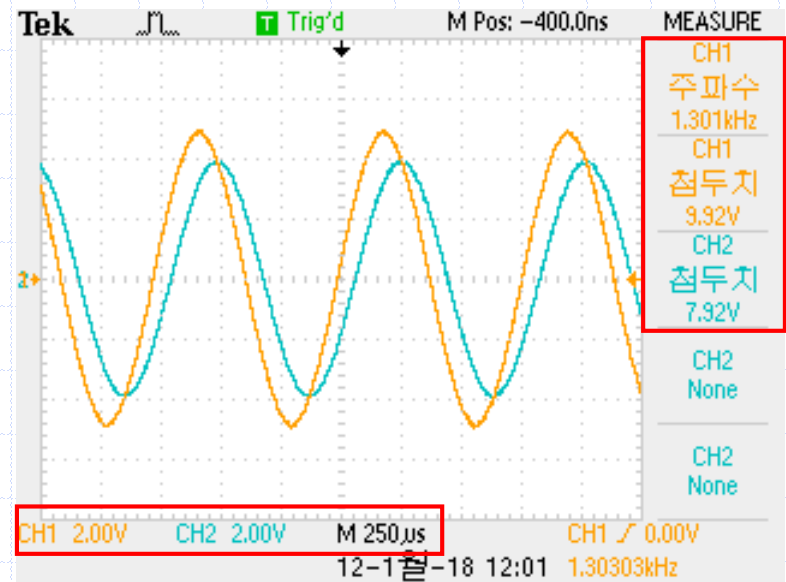
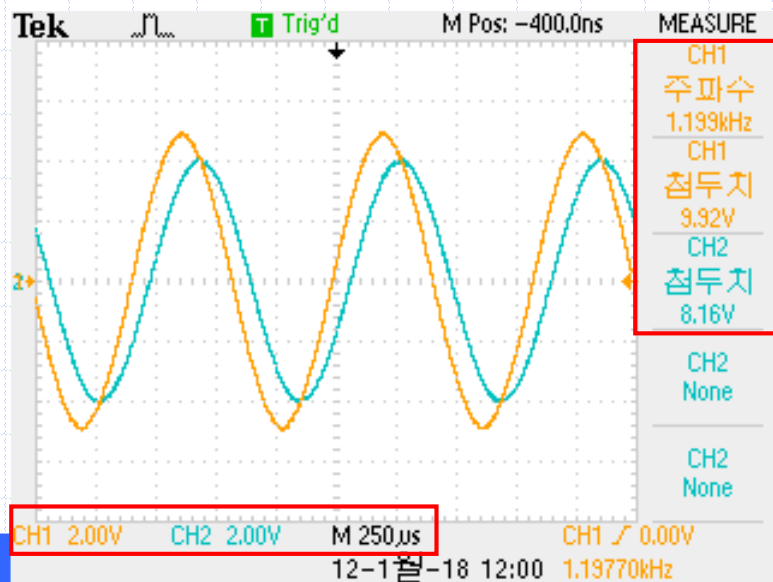
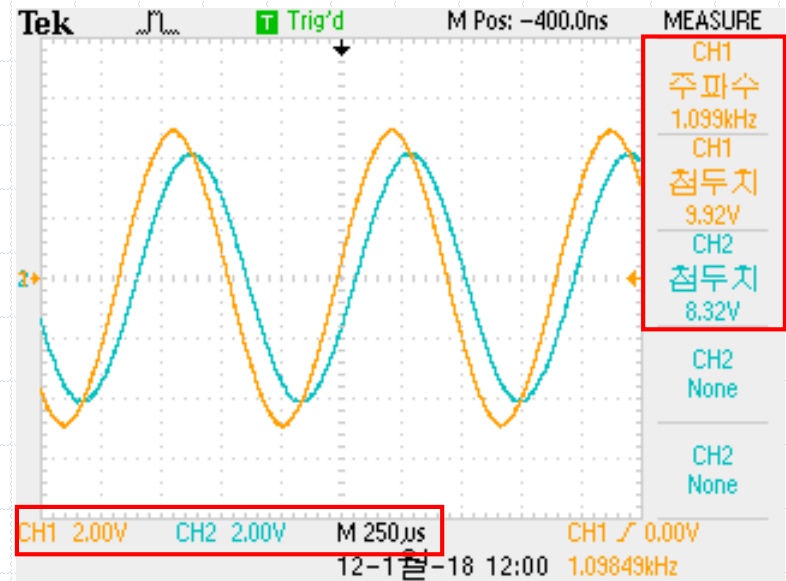
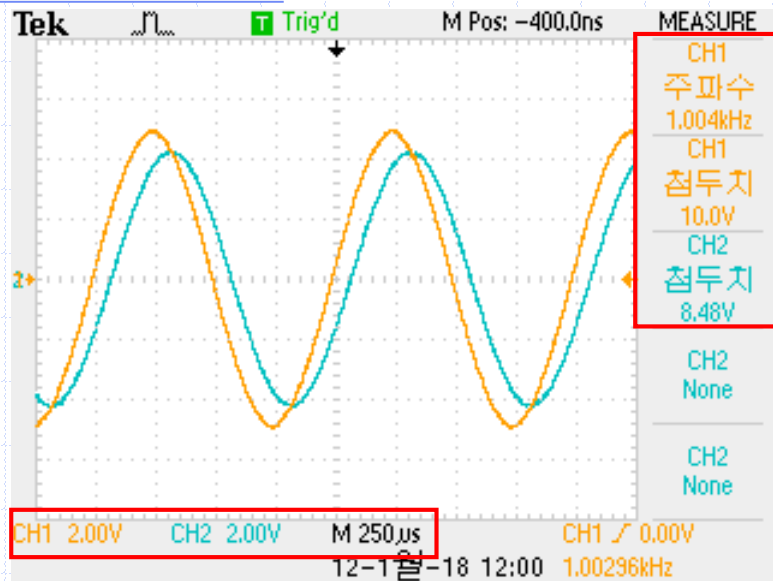

16-4. RC Low Pass Filter-LPF

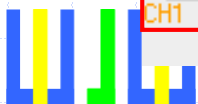
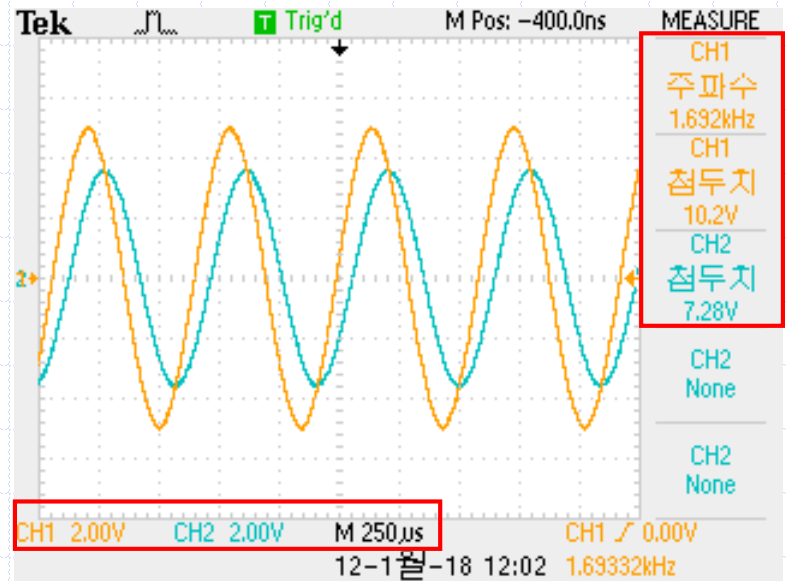
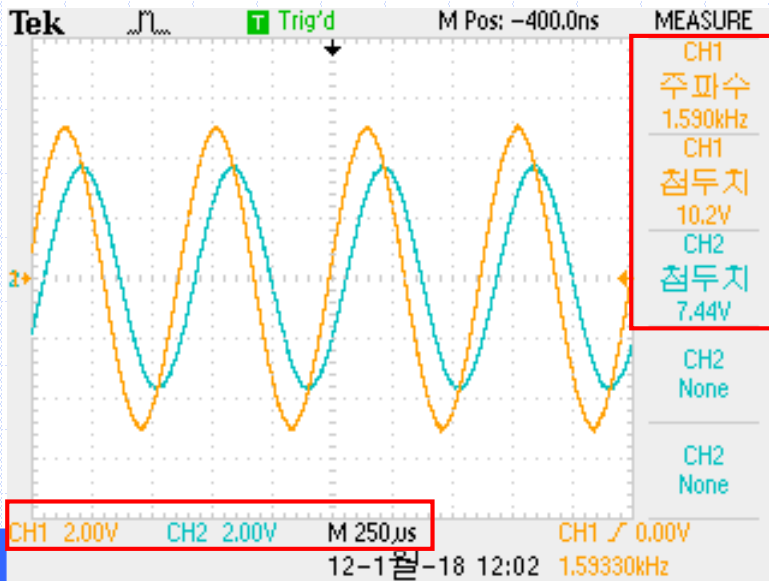
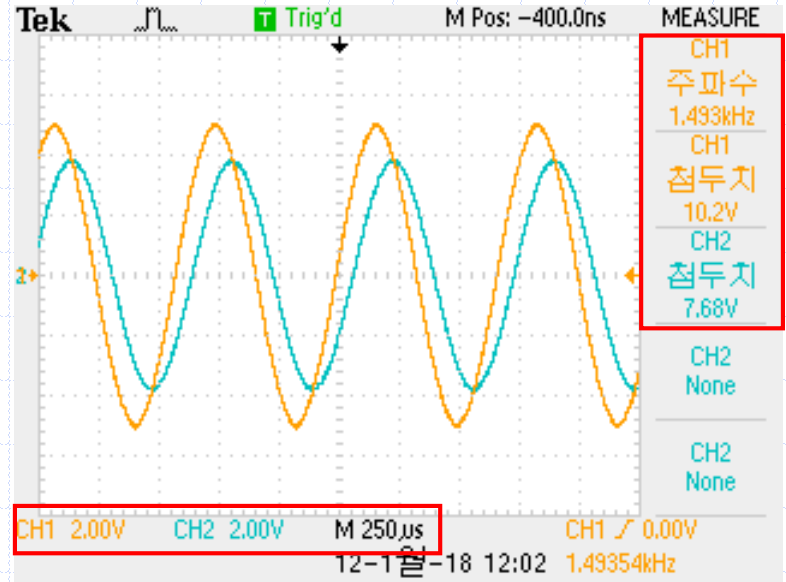
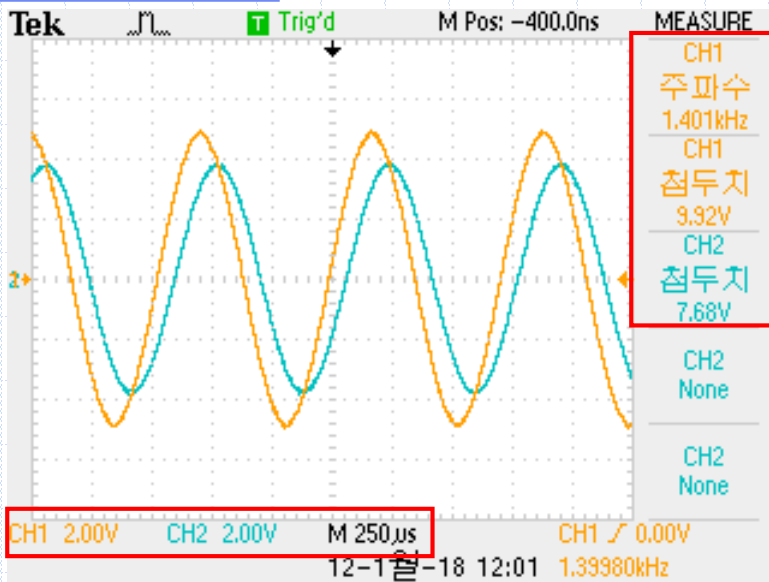

16-4. RC Low Pass Filter-LPF

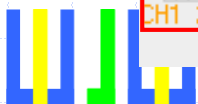
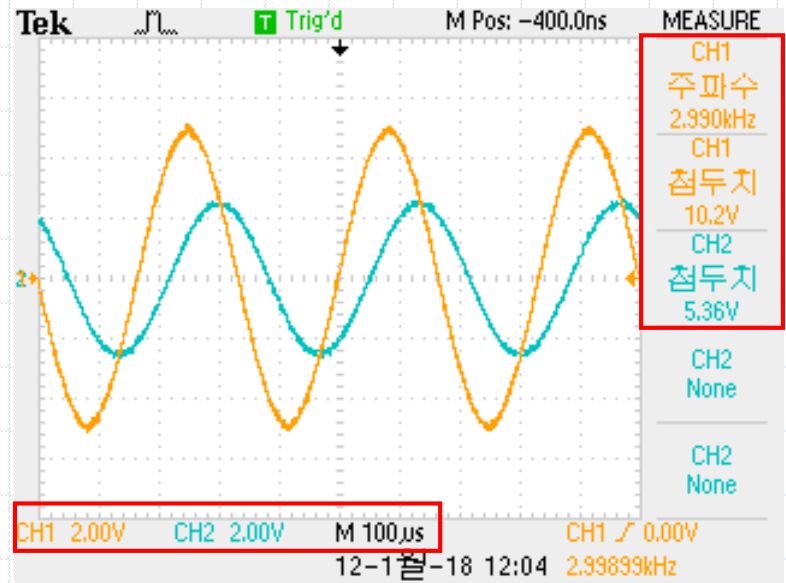
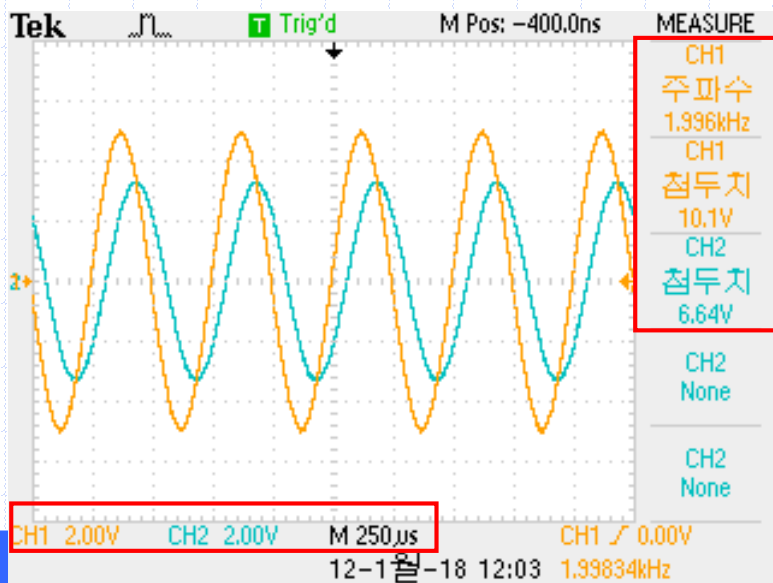
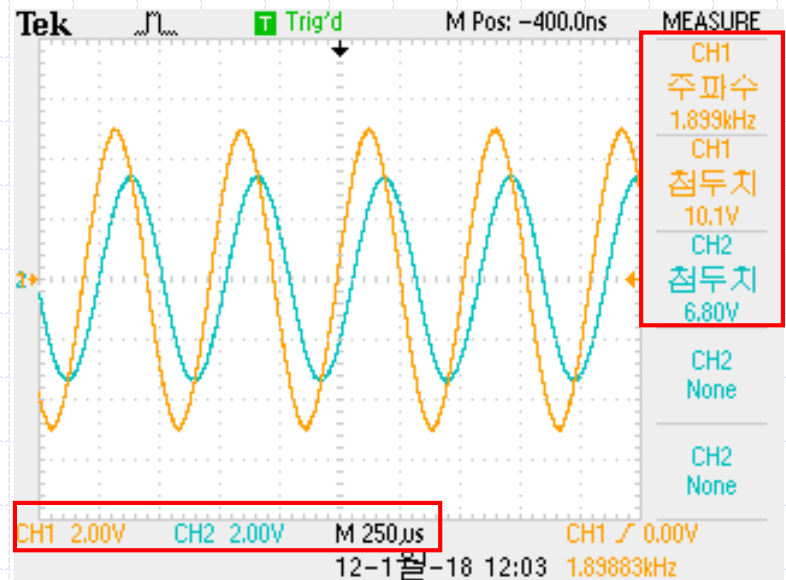
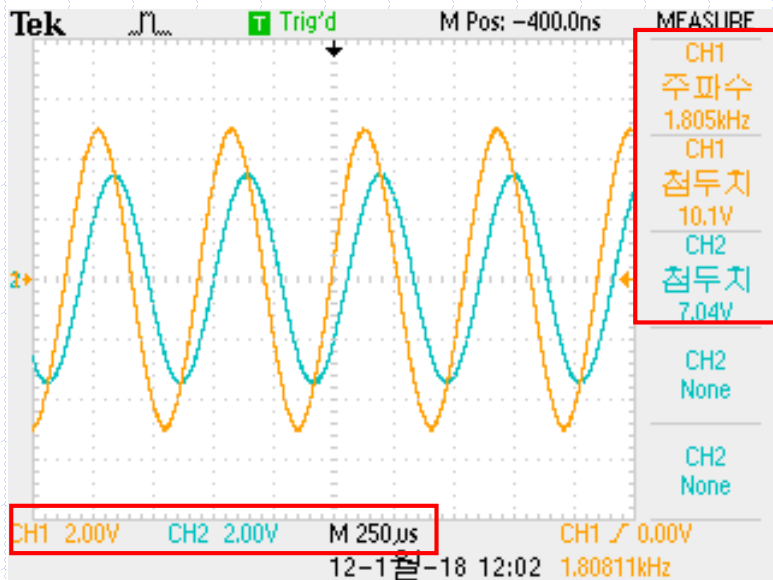

16-4. RC Low Pass Filter-LPF

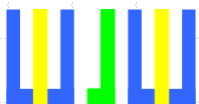
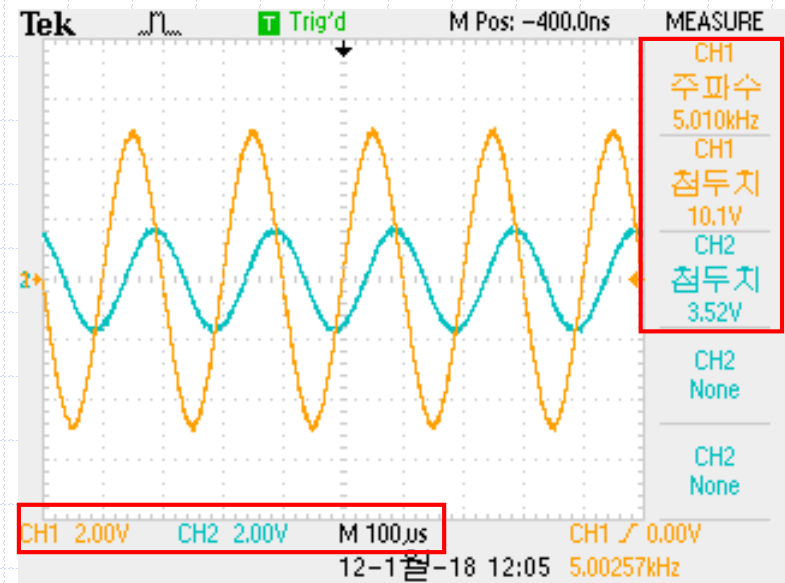
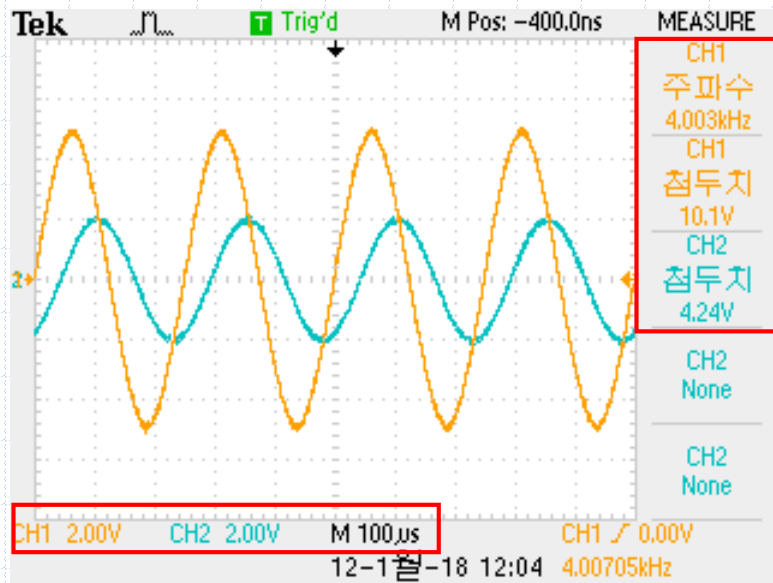

16-4. RC Low Pass Filter-LPF

주파수 (Hz)	Vin [Vpp]	계산값			측정값		
		Vout [Vpp]	이득	이득 (dB)	Vout [Vpp]	이득	이득 (dB)
500	10	9.54	0.95	-0.41	9.52	0.952	-0.427
1,000	10	8.47	0.85	-1.45	8.48	0.848	-1.432
1,100	10	8.23	0.82	-1.70	8.32	0.832	-1.598
1,200	10	7.98	0.80	-1.95	8.16	0.816	-1.766
1,300	10	7.74	0.77	-2.22	7.92	0.792	-2.025
1,400	10	7.51	0.75	-2.49	7.68	0.768	-2.293
1,500	10	7.28	0.73	-2.76	7.68	0.768	-2.293
1,600	10	7.05	0.71	-3.03	7.44	0.744	-2.569
1,700	10	6.83	0.68	-3.31	7.28	0.728	-2.757
1,800	10	6.62	0.66	-3.58	7.04	0.704	-3.049
1,900	10	6.42	0.64	-3.85	6.8	0.68	-3.350
2,000	10	6.23	0.62	-4.11	6.64	0.664	-3.557
3,000	10	4.69	0.47	-6.58	5.36	0.536	-5.417
4,000	10	3.70	0.37	-8.64	4.24	0.424	-7.453
5,000	10	3.03	0.30	-10.36	3.52	0.352	-9.069

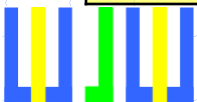

16-4. RC Low Pass Filter-LPF

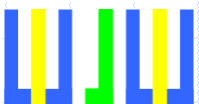
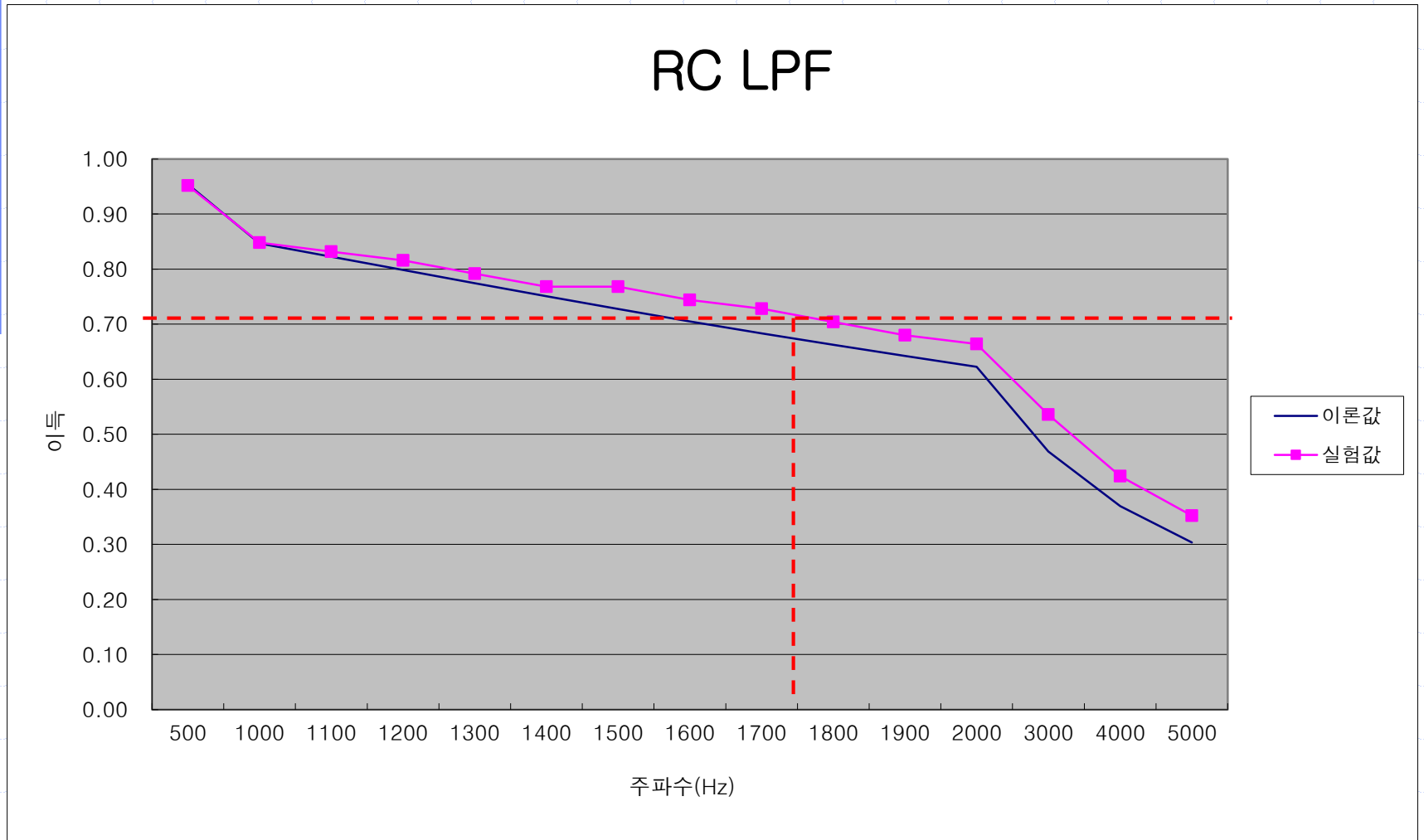

16-4. RC Low Pass Filter-LPF

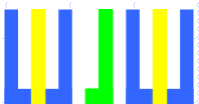
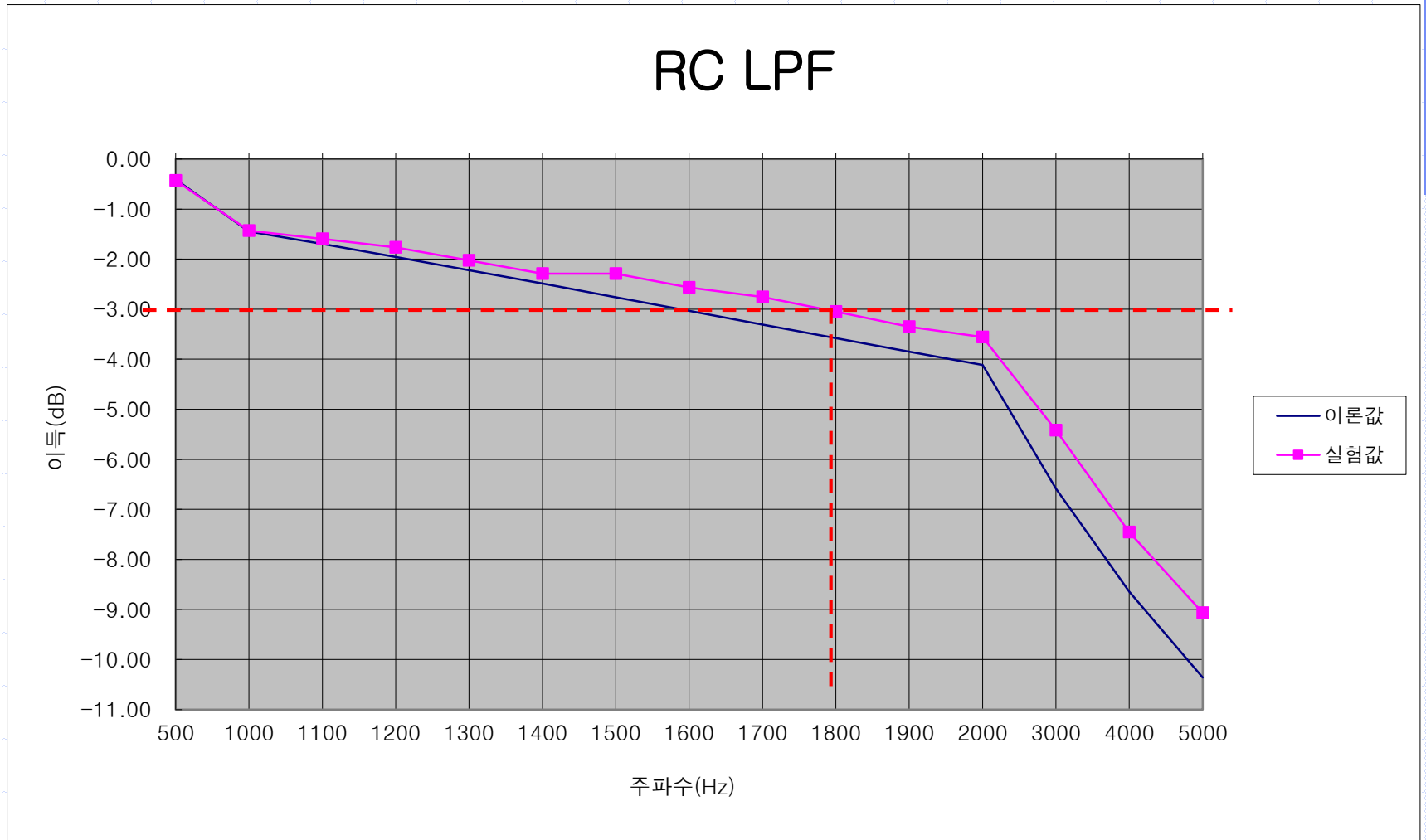

16-4. RC Low Pass Filter-LPF

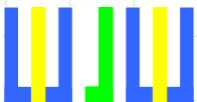
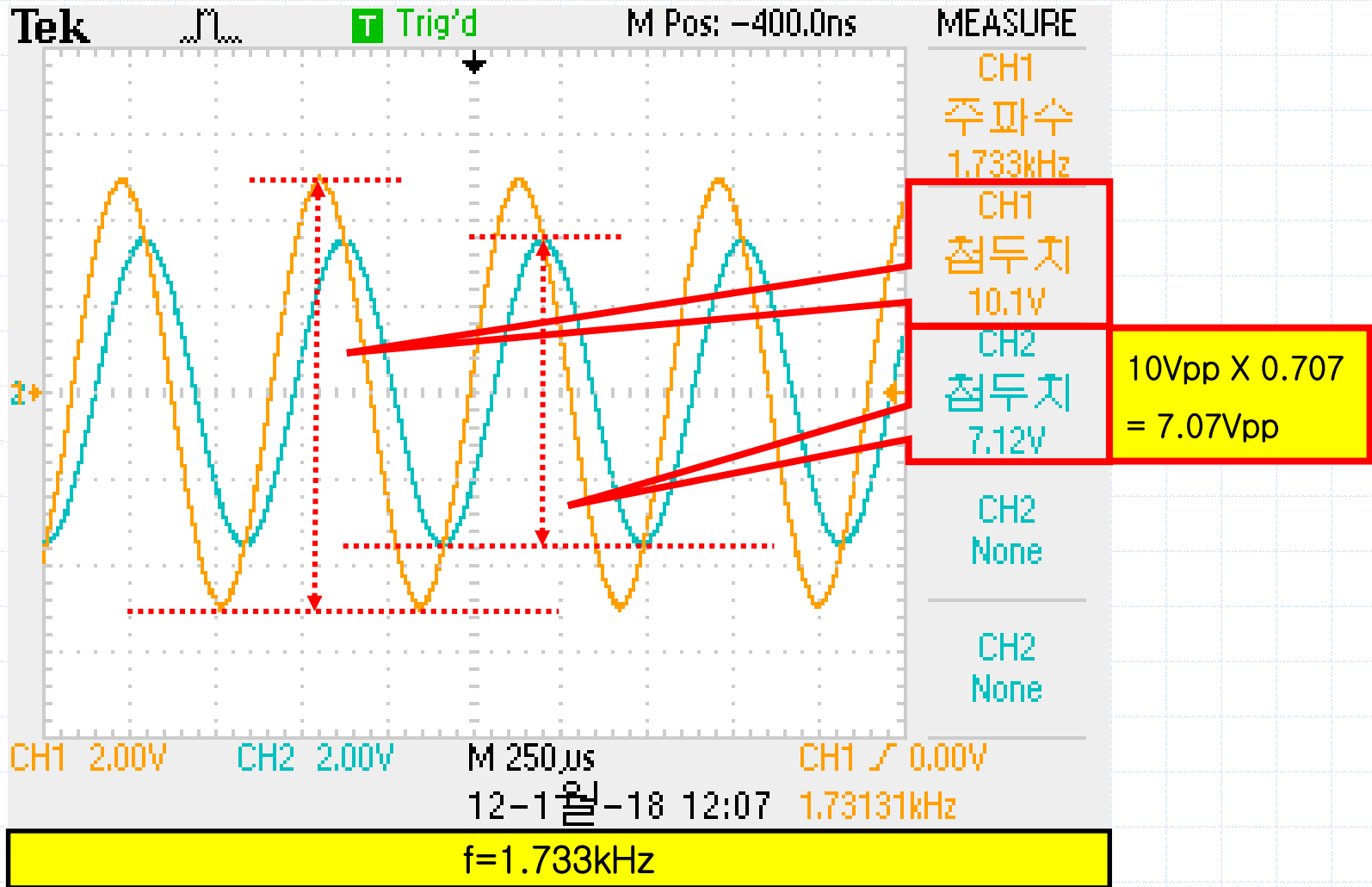

16-5. RL Low Pass Filter-LPF

- 다음과 같이 회로를 연결하고, 신호발생기를 조절하여 주파수 5,000Hz, 10Vpp 의 정현파가 나오도록 한다.

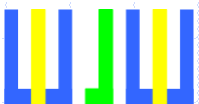
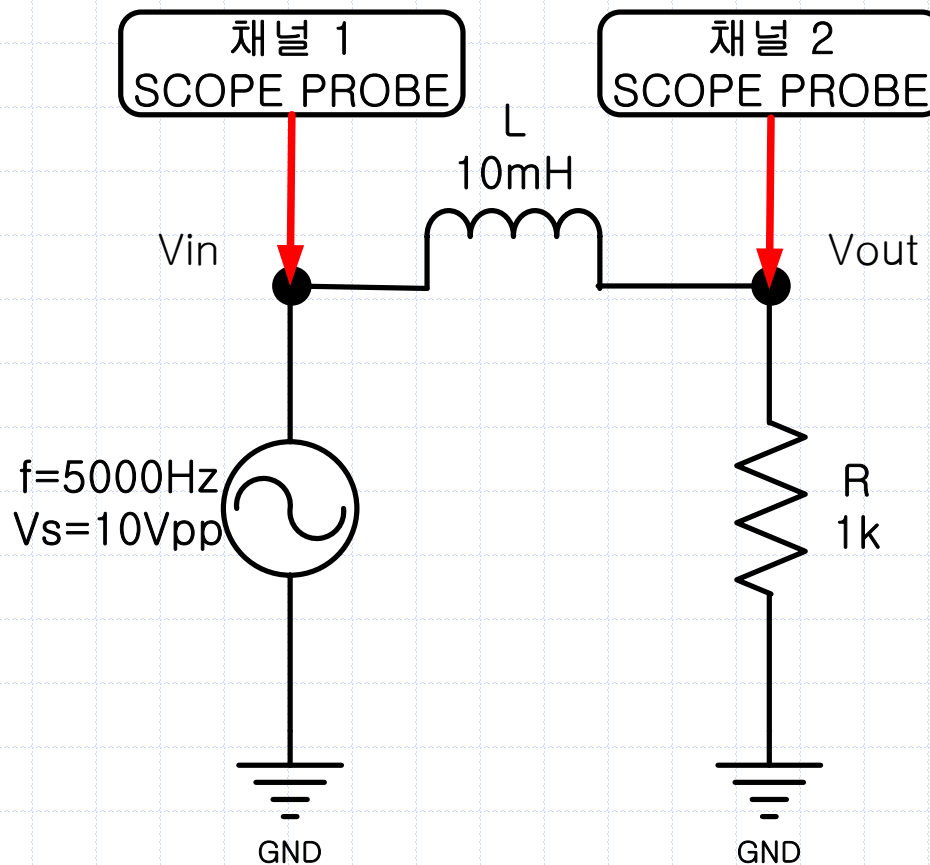

16-5. RL Low Pass Filter-LPF

- ✓ 다음과 같이 회로를 연결하고, 신호발생기를 조절하여 주파수 5,000Hz, 10Vpp 의 정현파가 나오도록 한다.

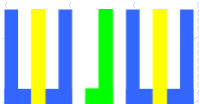
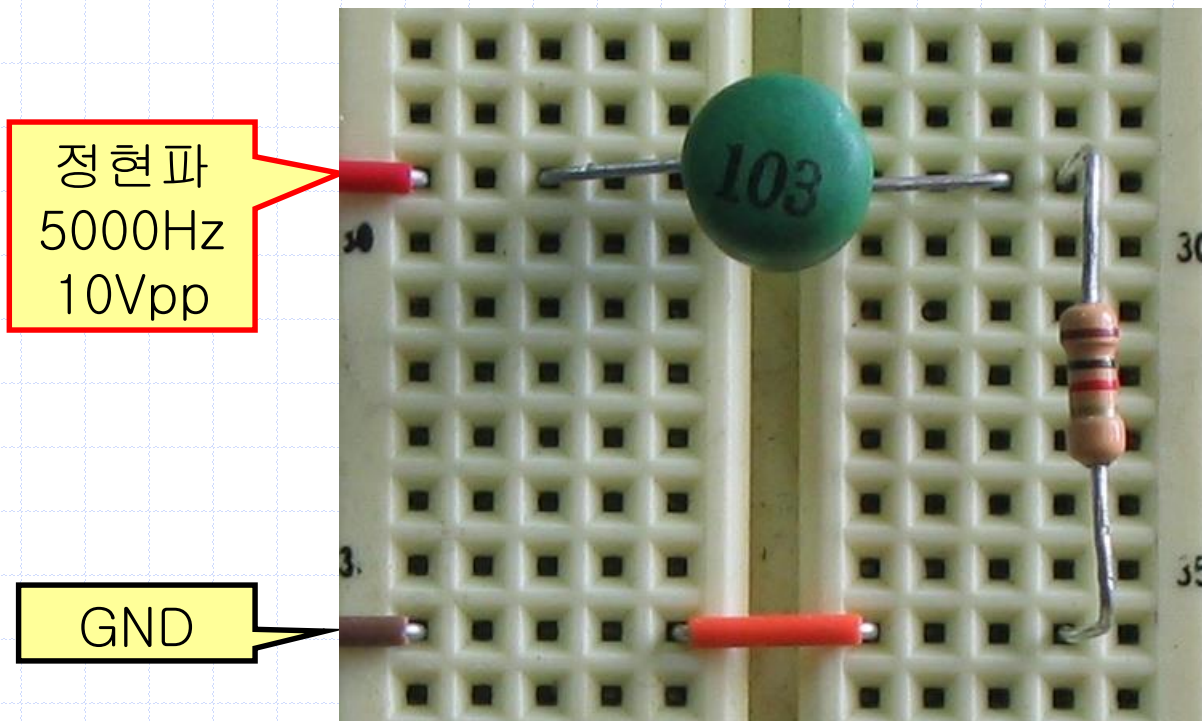

16-5. RL Low Pass Filter-LPF

- ✓ 오실로스코프의 CH 1 을 이용하여 입력 전압(V_{in})을 측정하고, CH 2는 출력 전압(V_{out})을 측정한다.

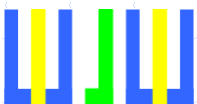
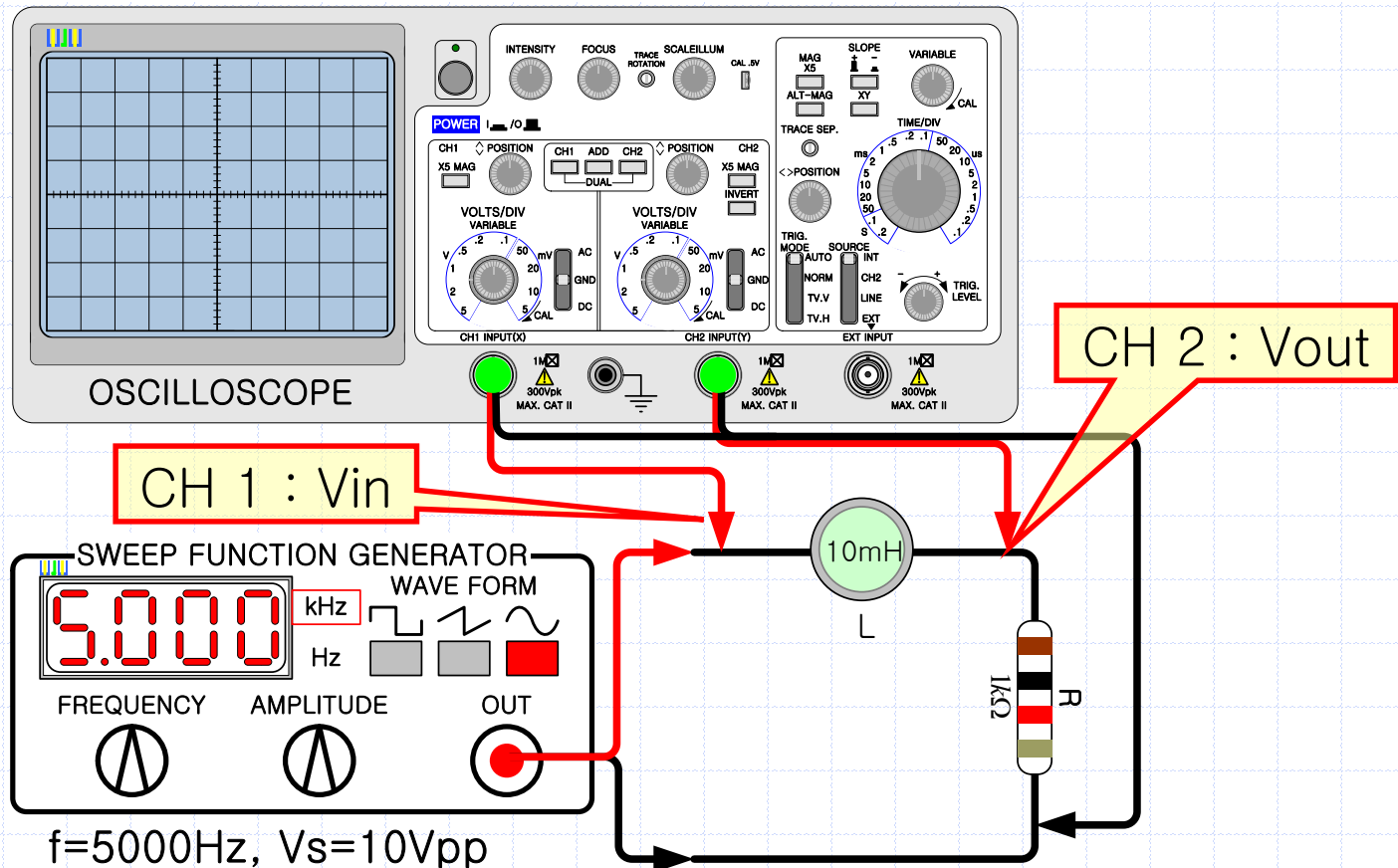

16-5. RL Low Pass Filter-LPF

✓ 주파수 : 5,000Hz

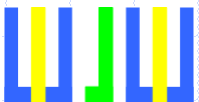
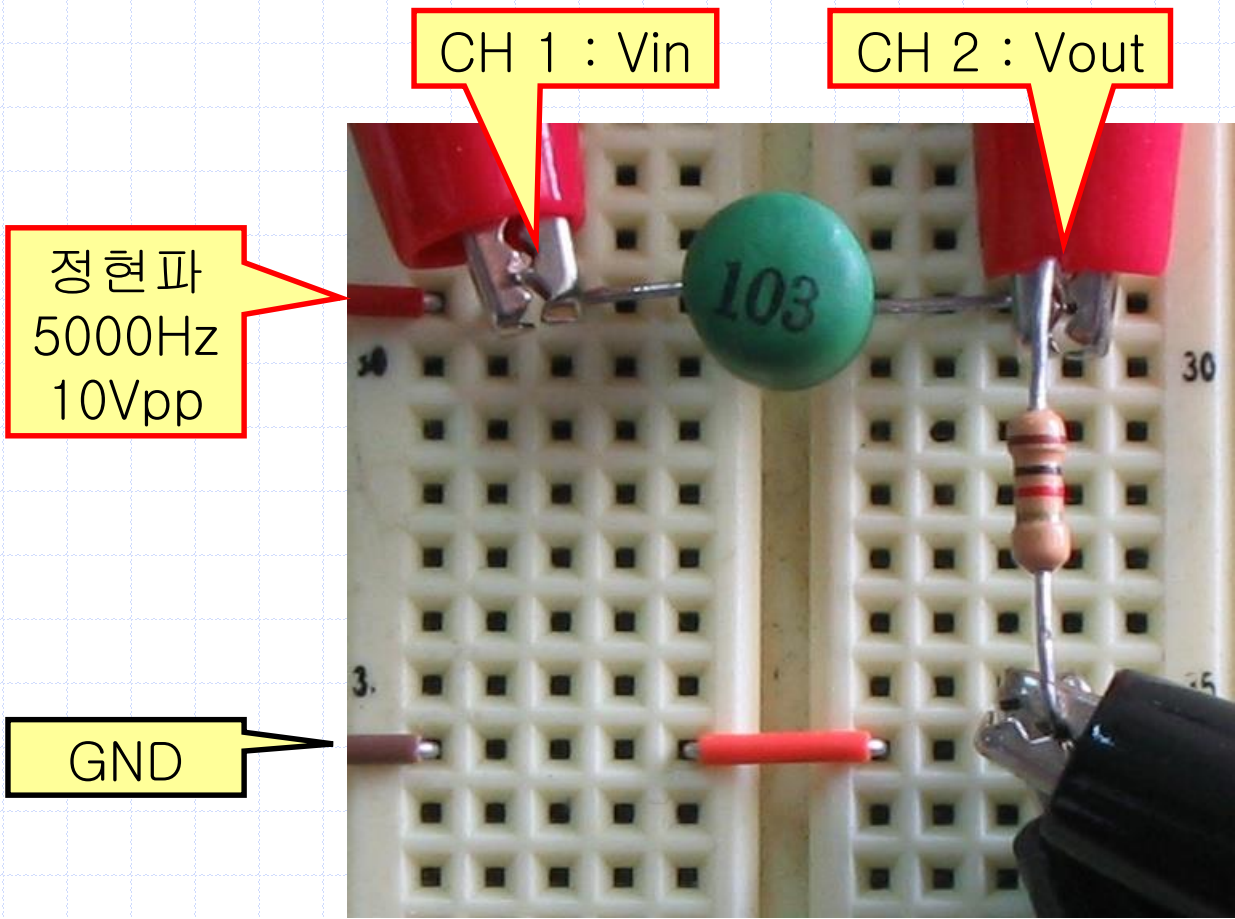

16-5. RL Low Pass Filter-LPF

✓ 주파수 : 5,000Hz

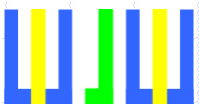
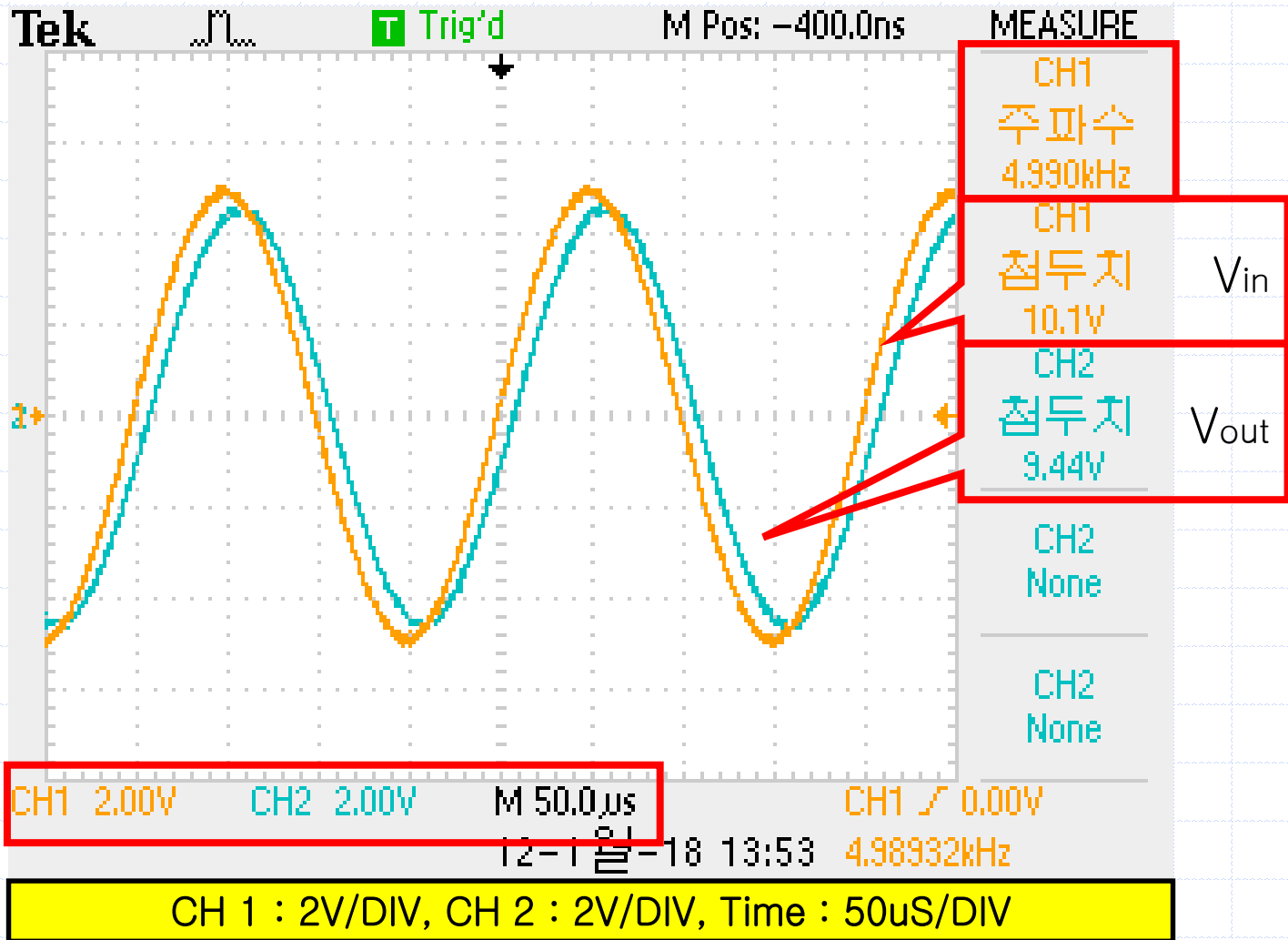

16-5. RL Low Pass Filter-LPF

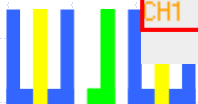
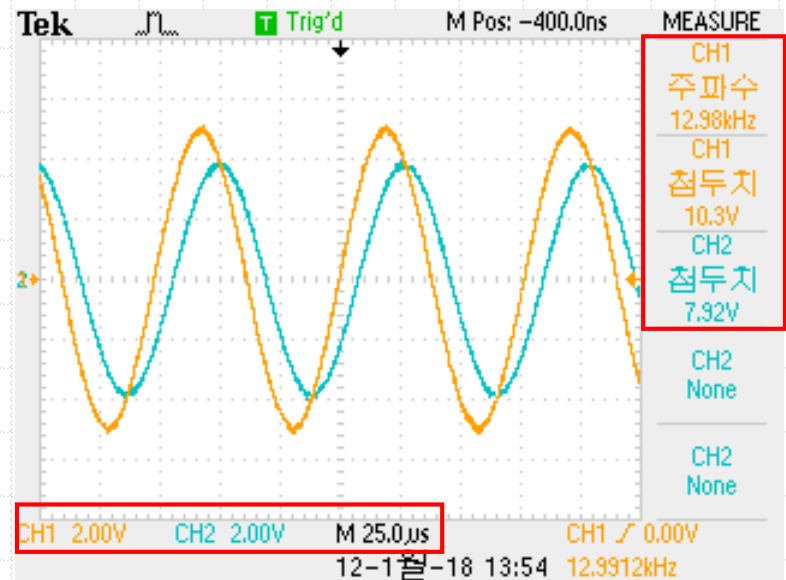
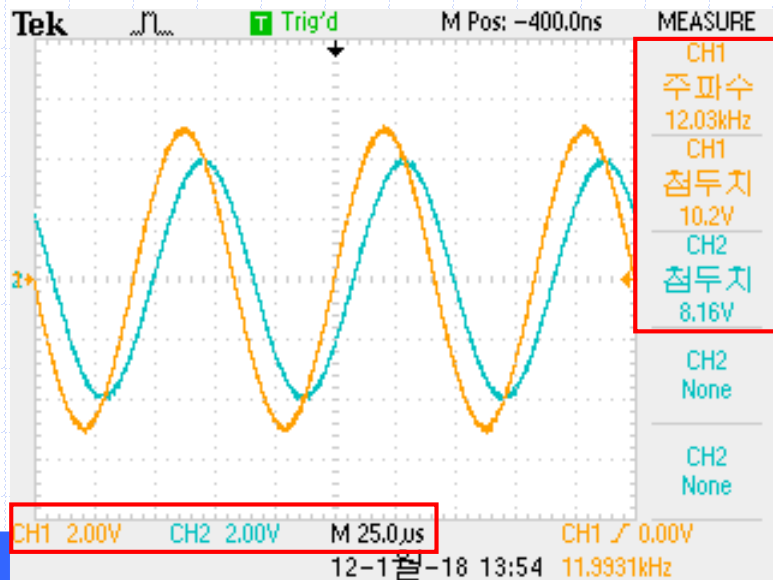
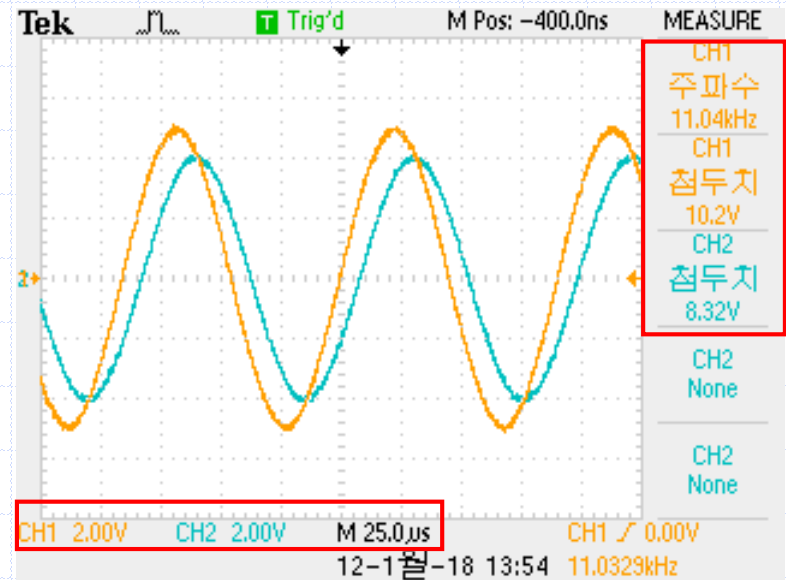
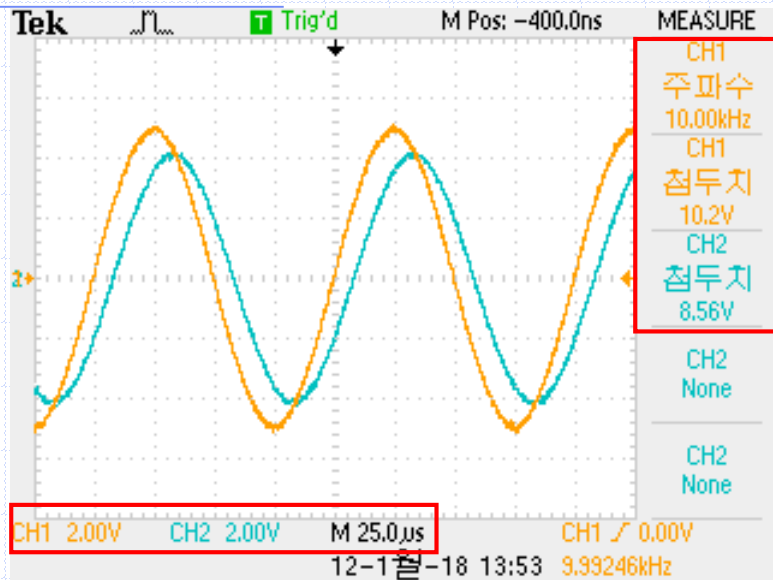

16-5. RL Low Pass Filter-LPF

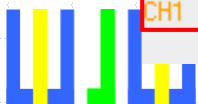
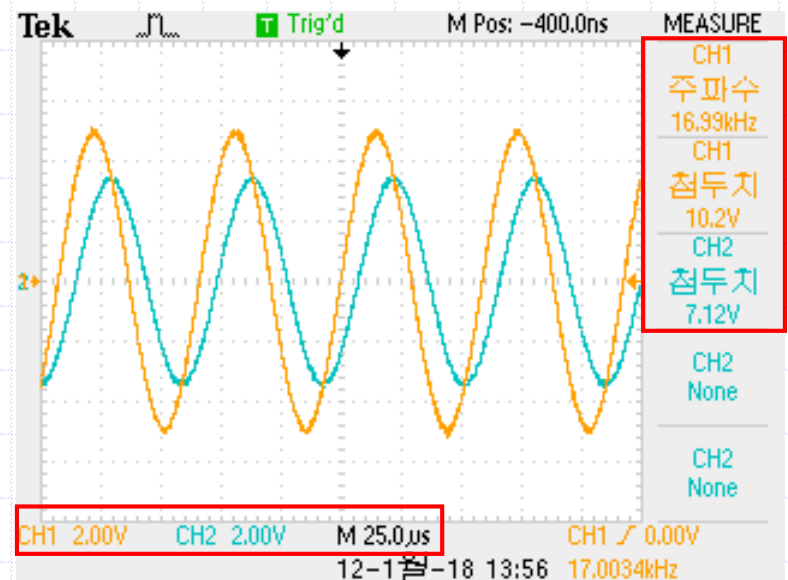
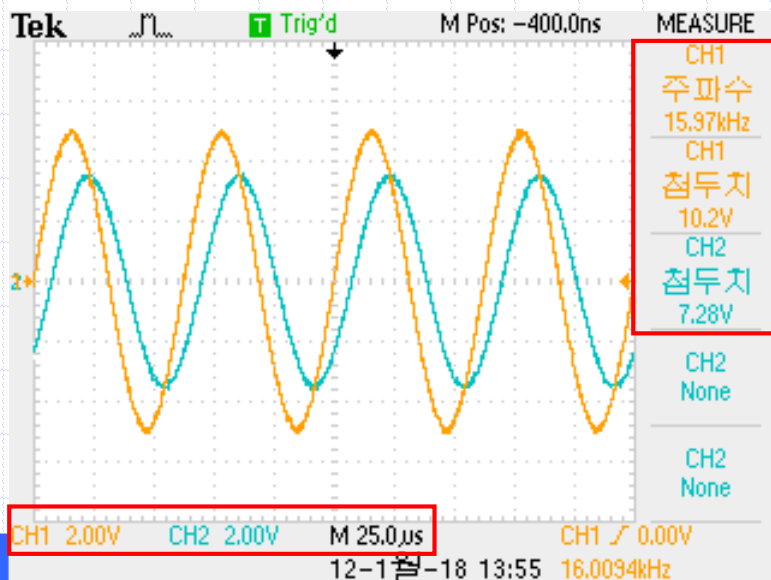
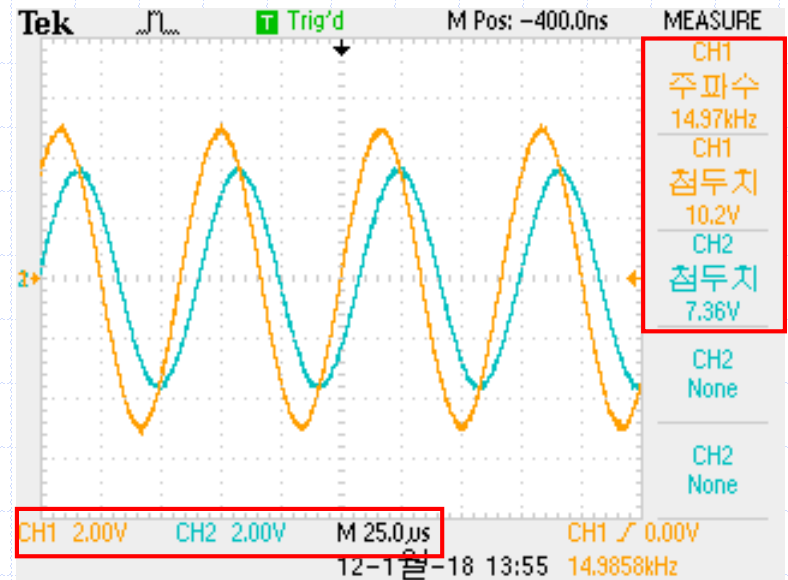
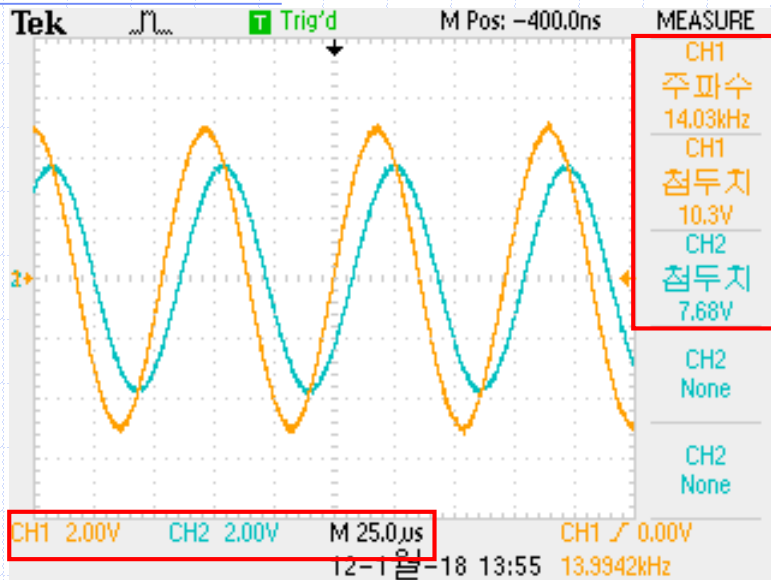

16-5. RL Low Pass Filter-LPF

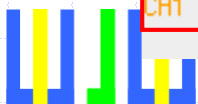
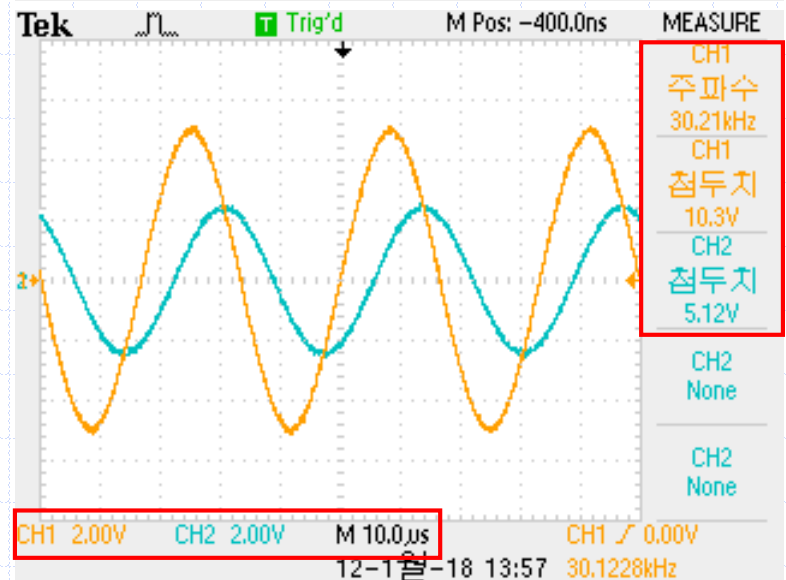
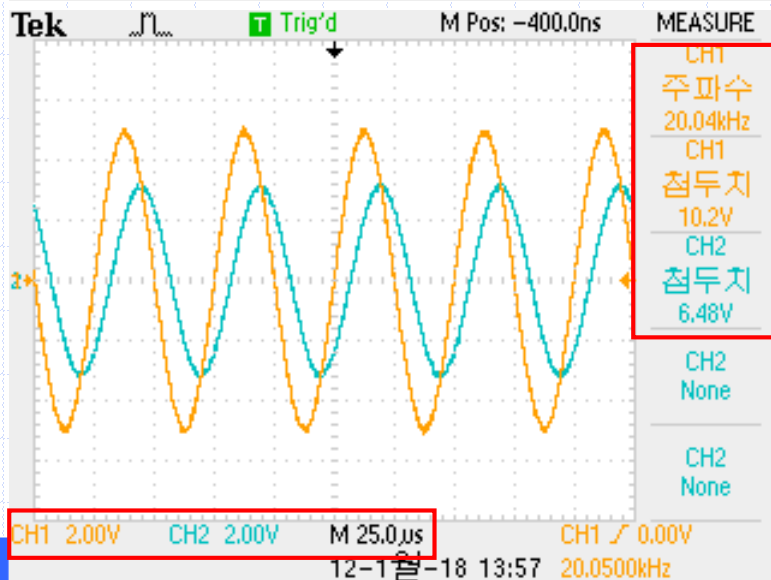
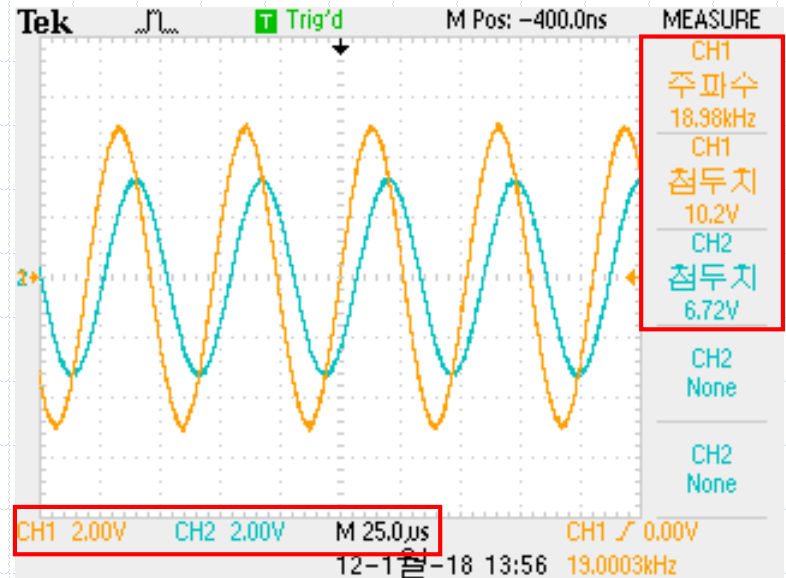
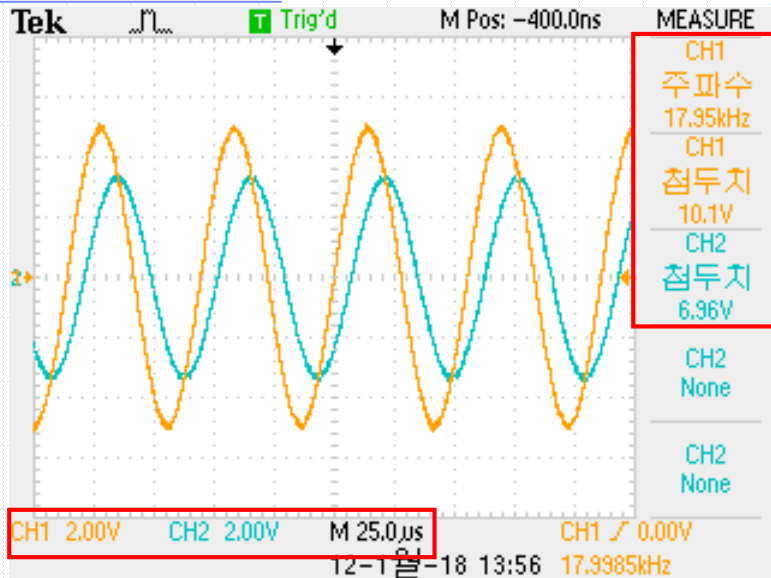

16-5. RL Low Pass Filter-LPF

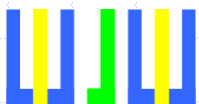
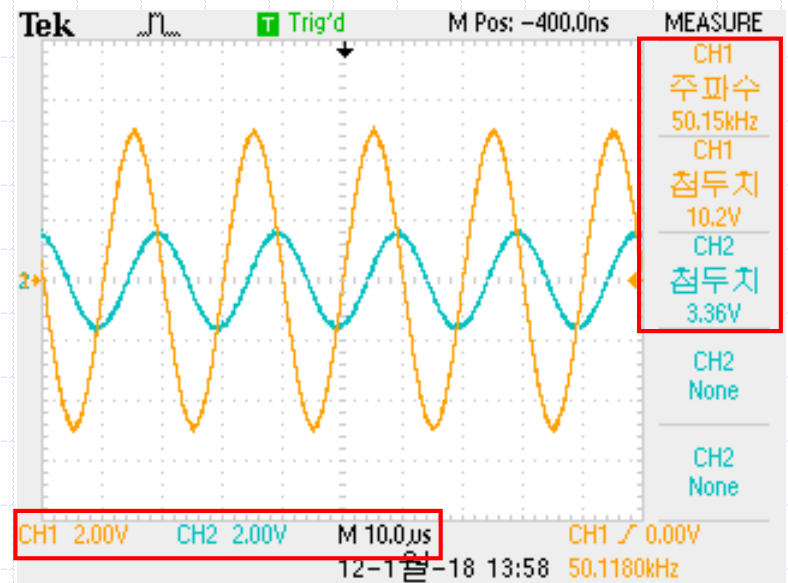
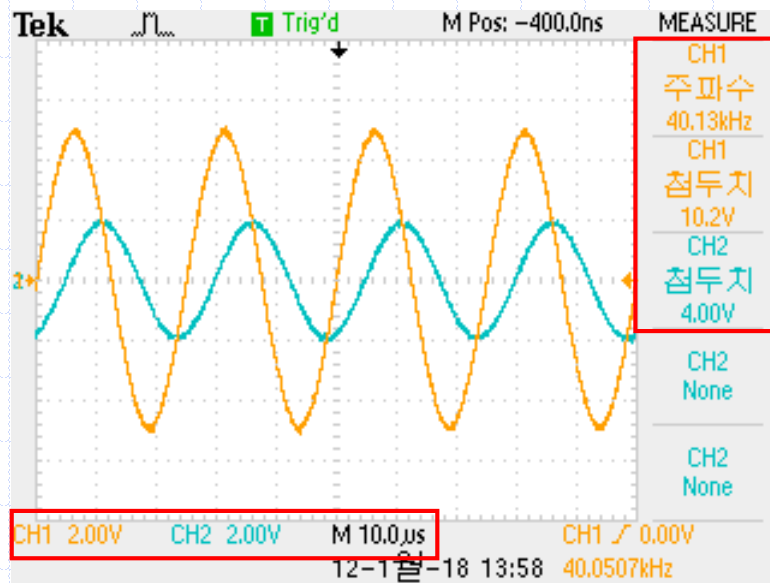

16-5. RL Low Pass Filter-LPF

주파수 (kHz)	Vin [Vpp]	계산값			측정값		
		Vout [Vpp]	이득	이득 (dB)	Vout [Vpp]	이득	이득 (dB)
5	10	9.54	0.95	-0.41	9.44	0.944	-0.501
10	10	8.47	0.85	-1.45	8.56	0.856	-1.351
11	10	8.23	0.82	-1.70	8.32	0.832	-1.598
12	10	7.98	0.80	-1.95	8.16	0.816	-1.766
13	10	7.74	0.77	-2.22	7.92	0.792	-2.025
14	10	7.51	0.75	-2.49	7.68	0.768	-2.293
15	10	7.28	0.73	-2.76	7.36	0.736	-2.662
16	10	7.05	0.71	-3.03	7.28	0.728	-2.757
17	10	6.83	0.68	-3.31	7.12	0.712	-2.950
18	10	6.62	0.66	-3.58	6.96	0.696	-3.148
19	10	6.42	0.64	-3.85	6.72	0.672	-3.453
20	10	6.23	0.62	-4.11	6.48	0.648	-3.768
30	10	4.69	0.47	-6.58	5.12	0.512	-5.815
40	10	3.70	0.37	-8.64	4.00	0.400	-7.959
50	10	3.03	0.30	-10.36	3.36	0.336	-9.473

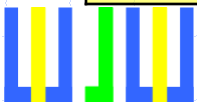

16-5. RL Low Pass Filter-LPF

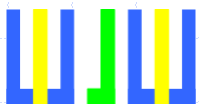
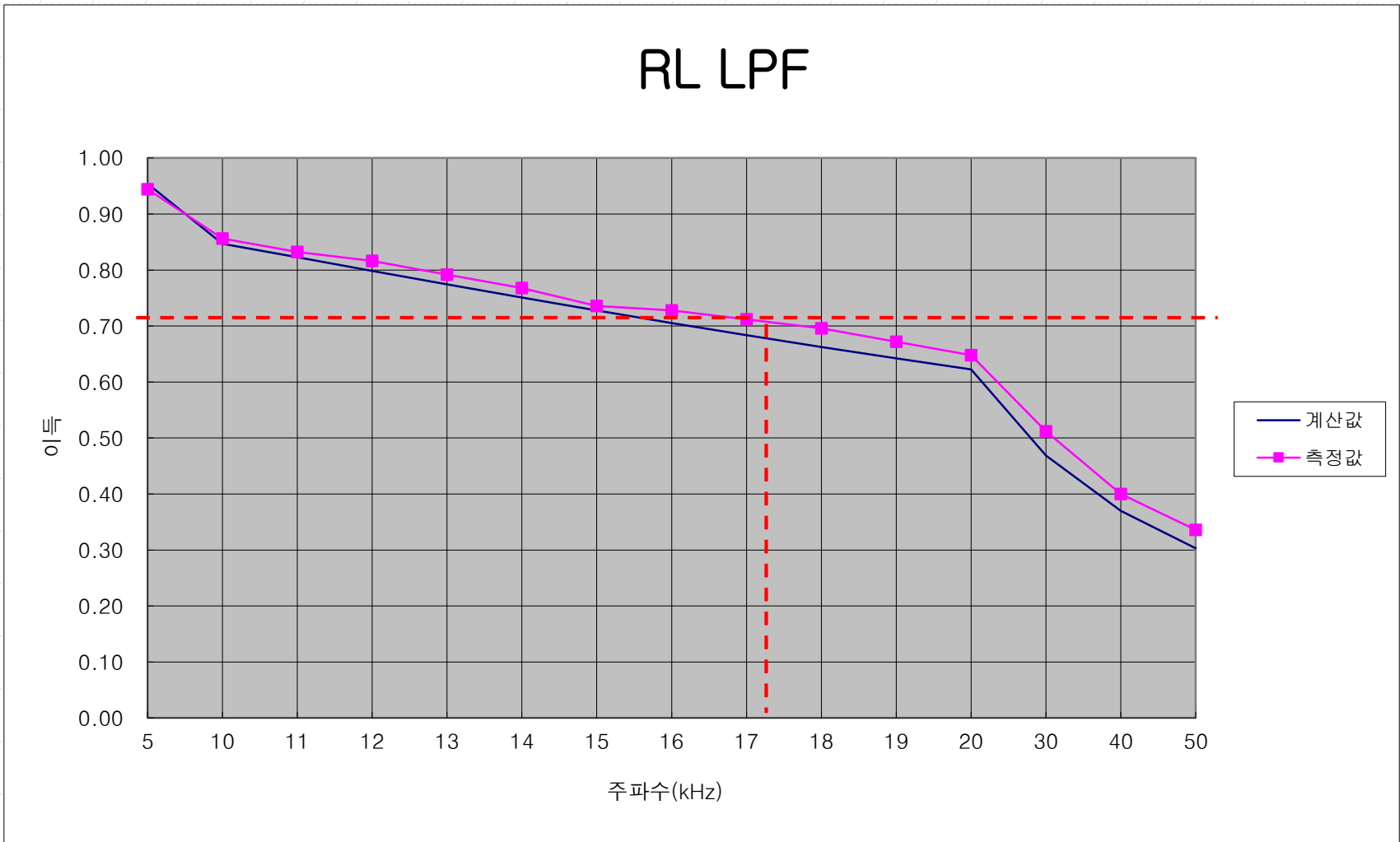

16-5. RL Low Pass Filter-LPF

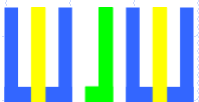
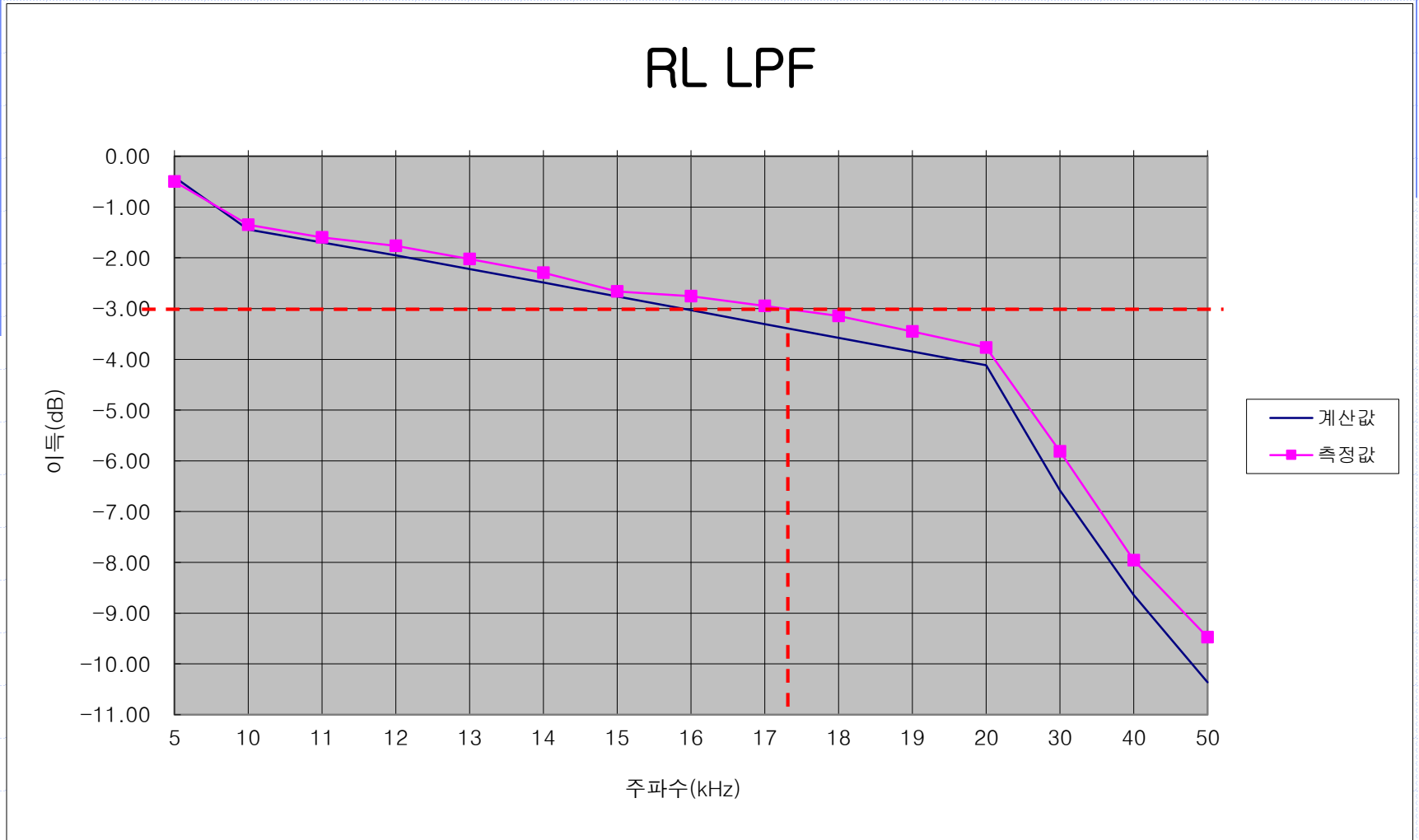

16-5. RL Low Pass Filter-LPF

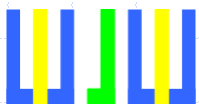
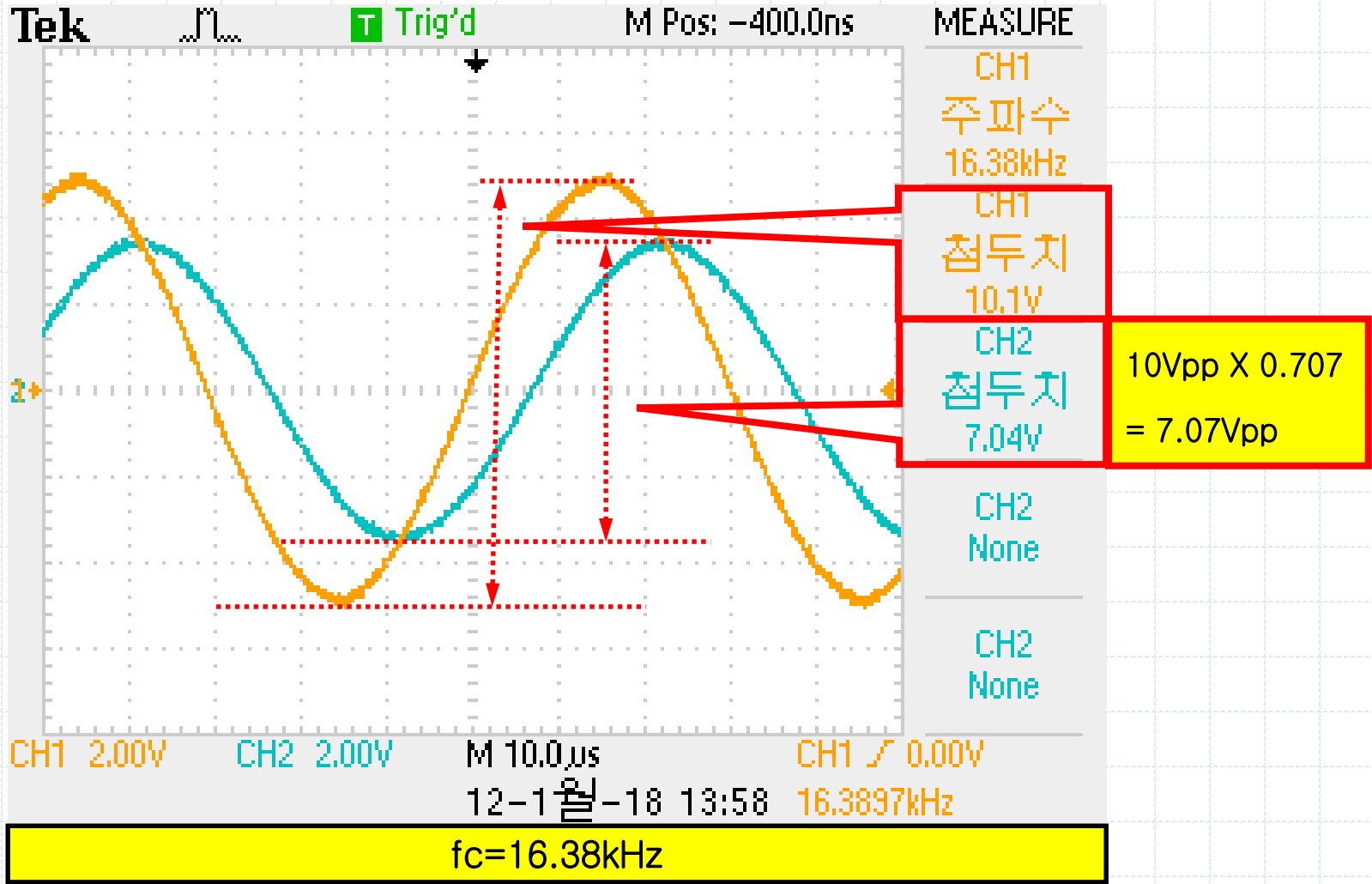

16-6. RL High Pass Filter-HPF

- 다음과 같이 회로를 연결하고, 신호발생기를 조절하여 주파수 5,000Hz, 10Vpp 의 정현파가 나오도록 한다.

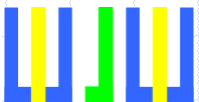
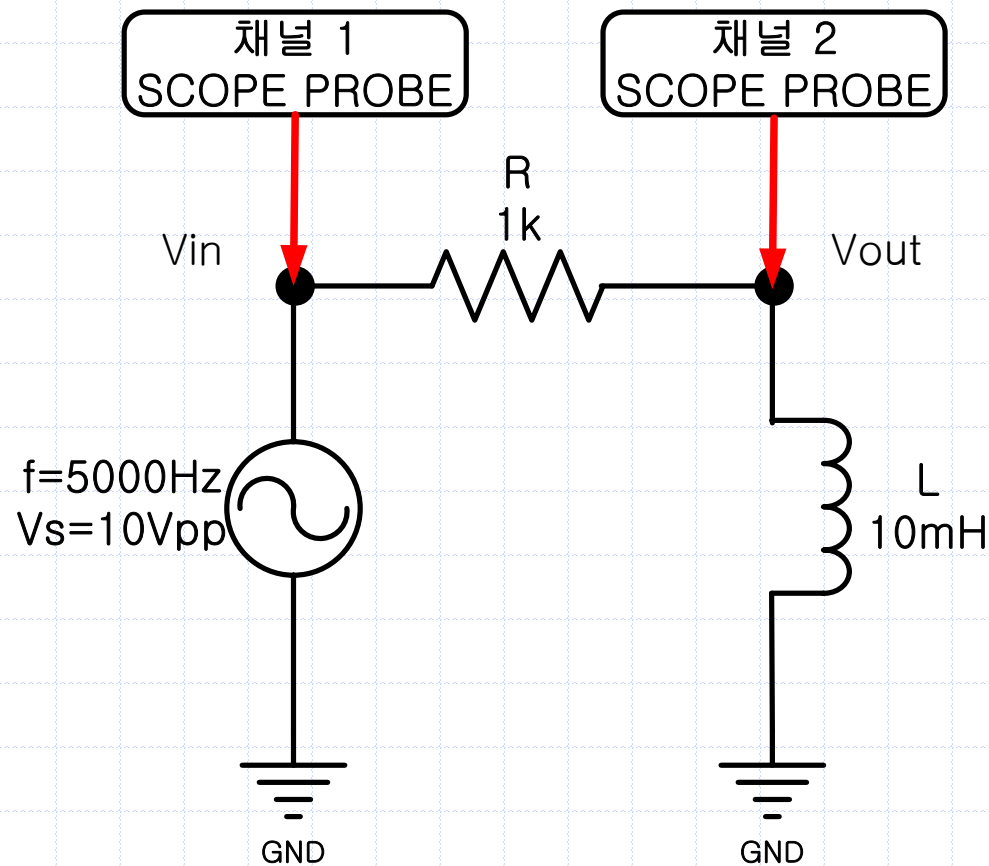

16-6. RL High Pass Filter-HPF

- ✓ 다음과 같이 회로를 연결하고, 신호발생기를 조절하여 주파수 5,000Hz, 10Vpp 의 정현파가 나오도록 한다.

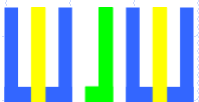
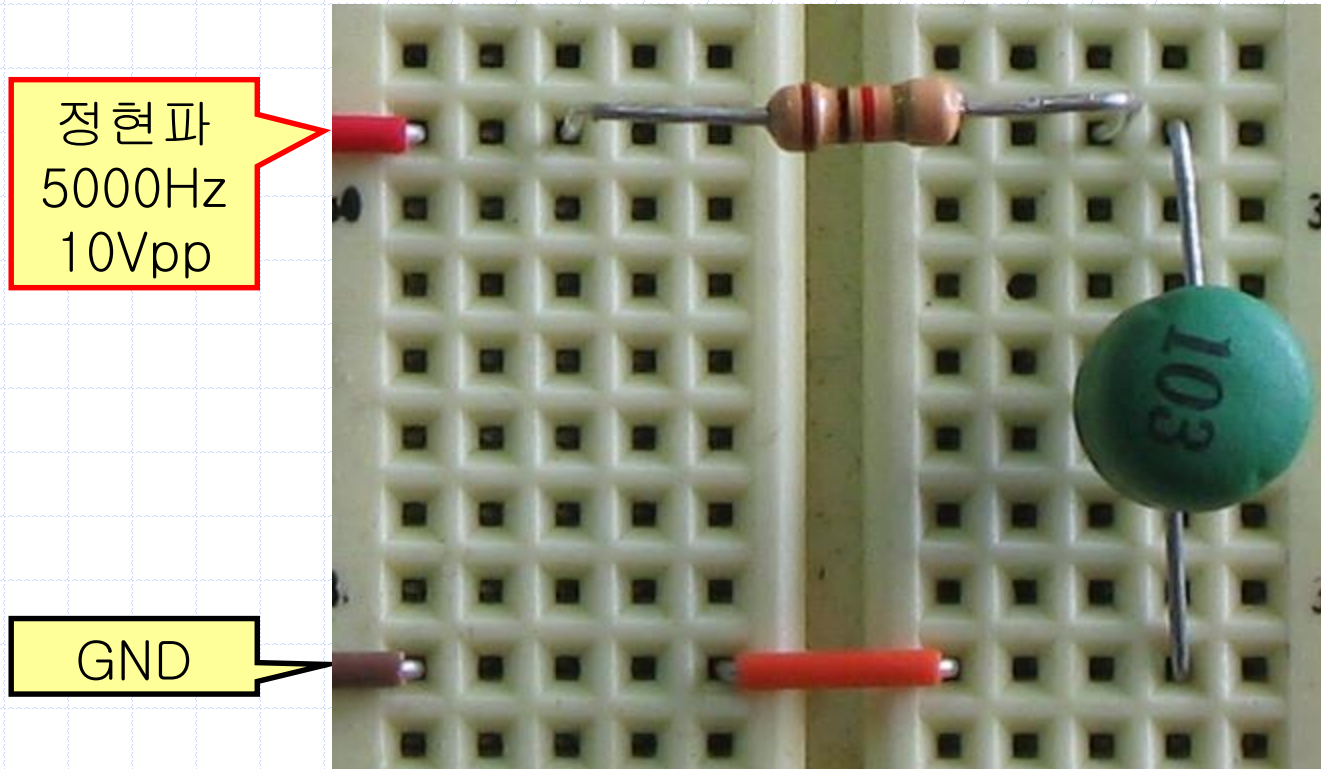

16-6. RL High Pass Filter-HPF

- ✓ 오실로스코프의 CH 1 을 이용하여 입력 전압(V_{in})을 측정하고, CH 2는 출력 전압(V_{out})을 측정한다.

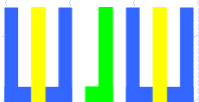
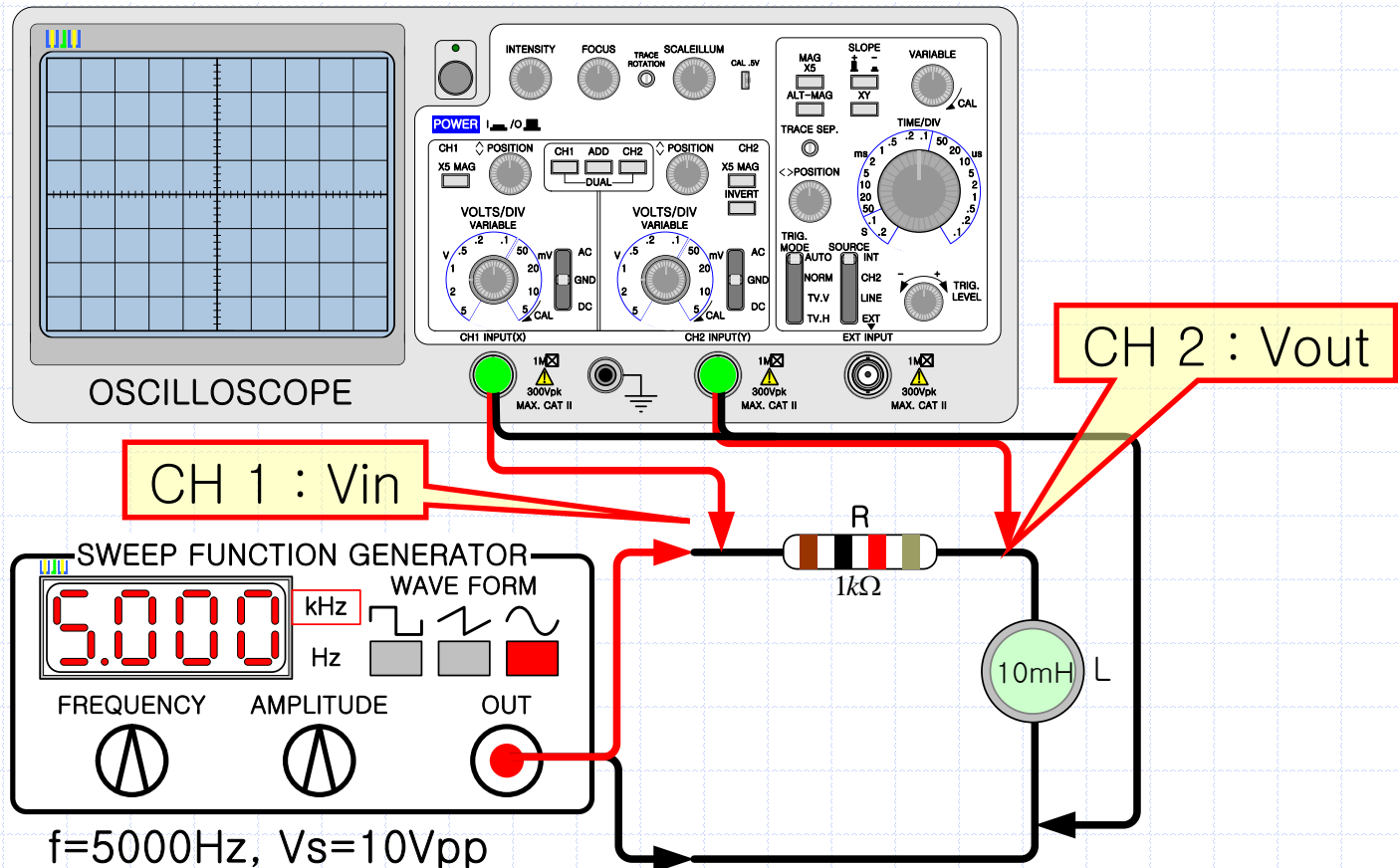

16-6. RL High Pass Filter-HPF

✓ 주파수 : 5,000Hz

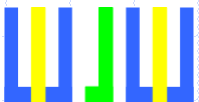
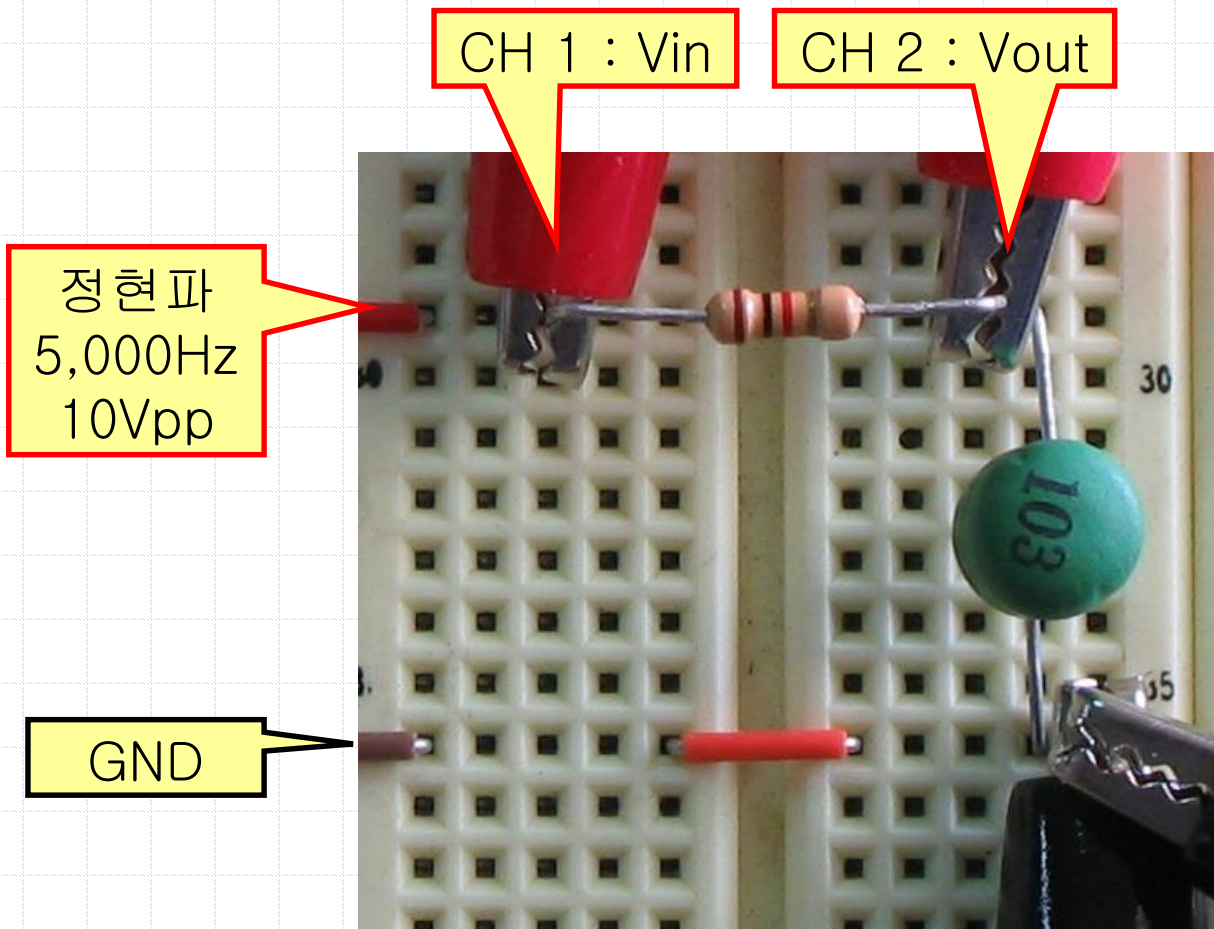

16-6. RL High Pass Filter-HPF

✓ 주파수 : 5,000Hz

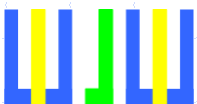
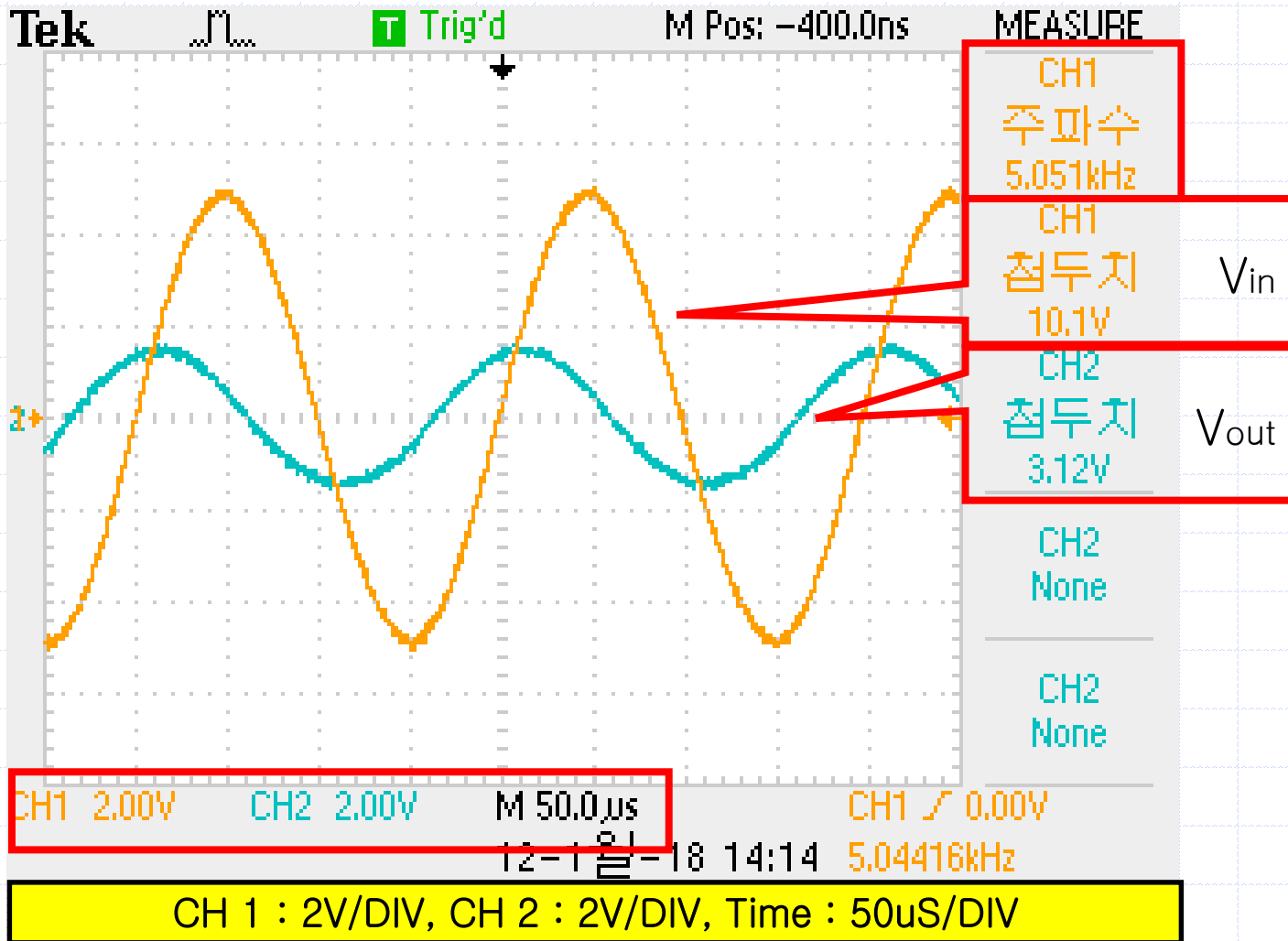

16-6. RL High Pass Filter-HPF

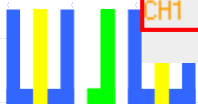
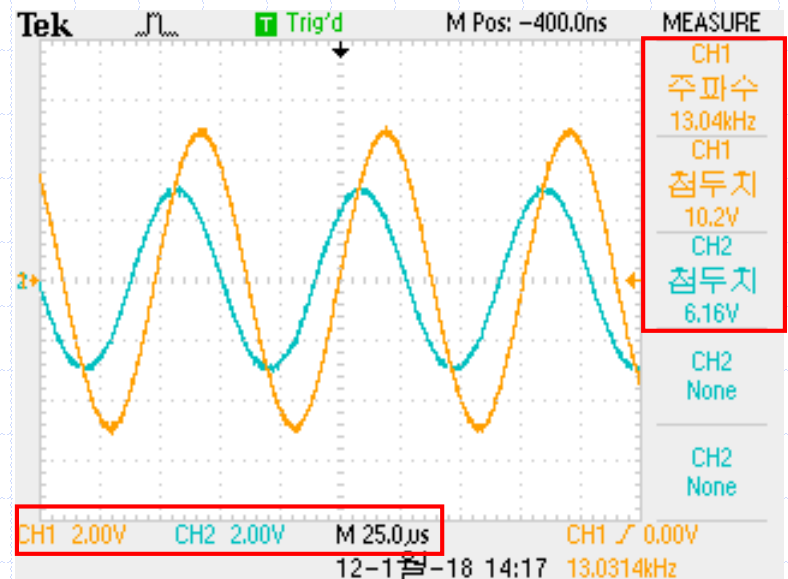
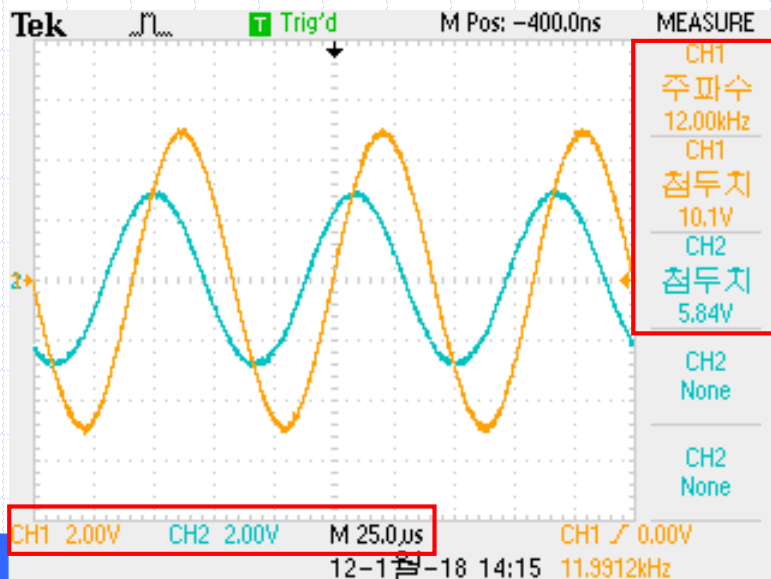
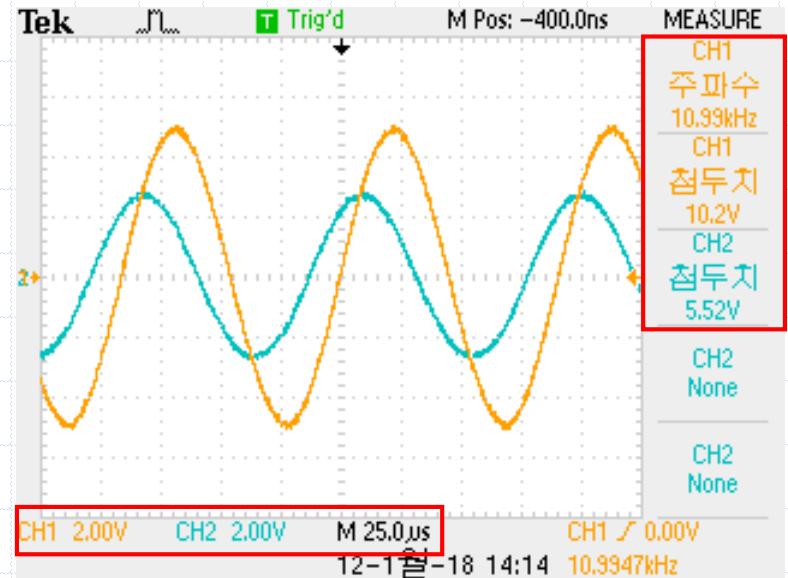
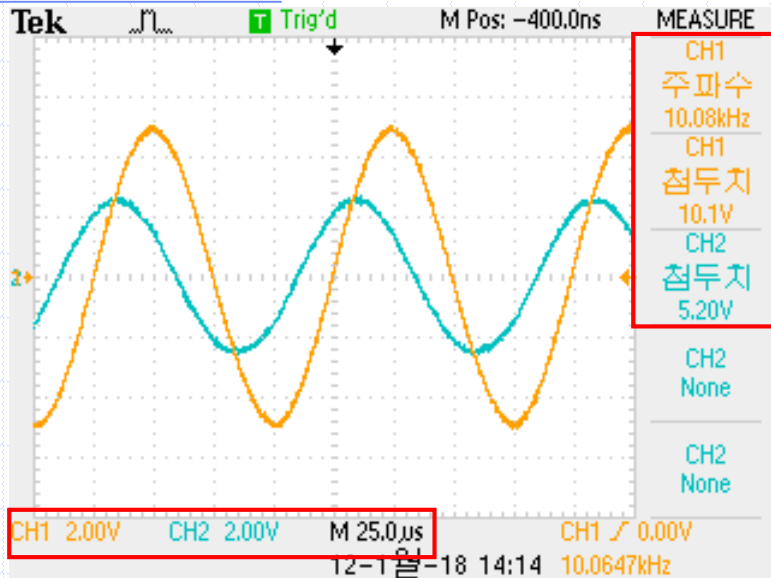

16-6. RL High Pass Filter-HPF

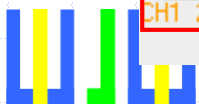
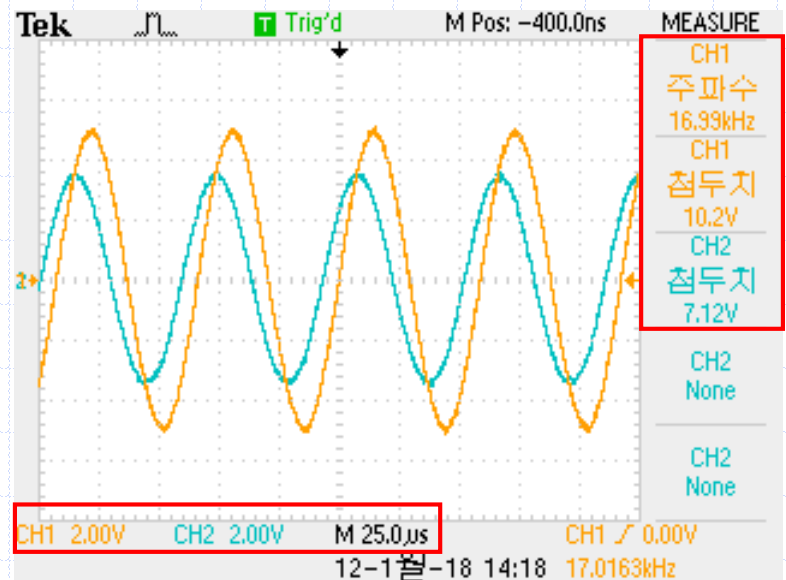
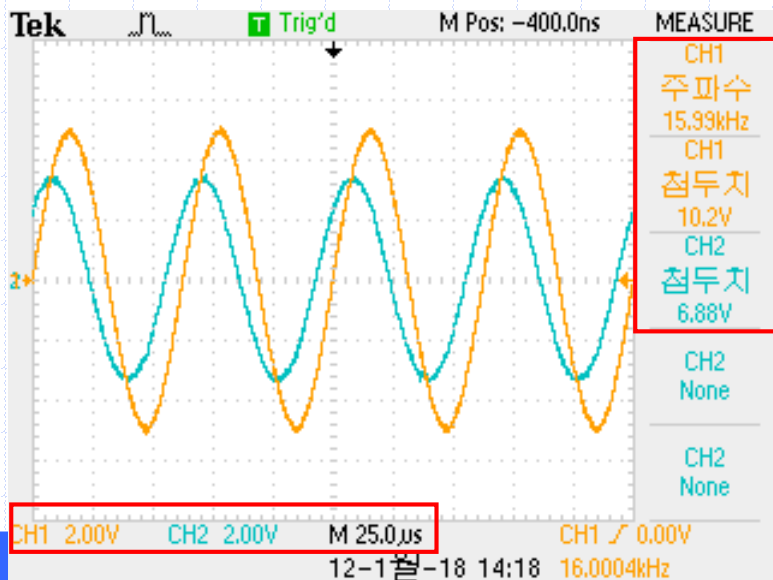
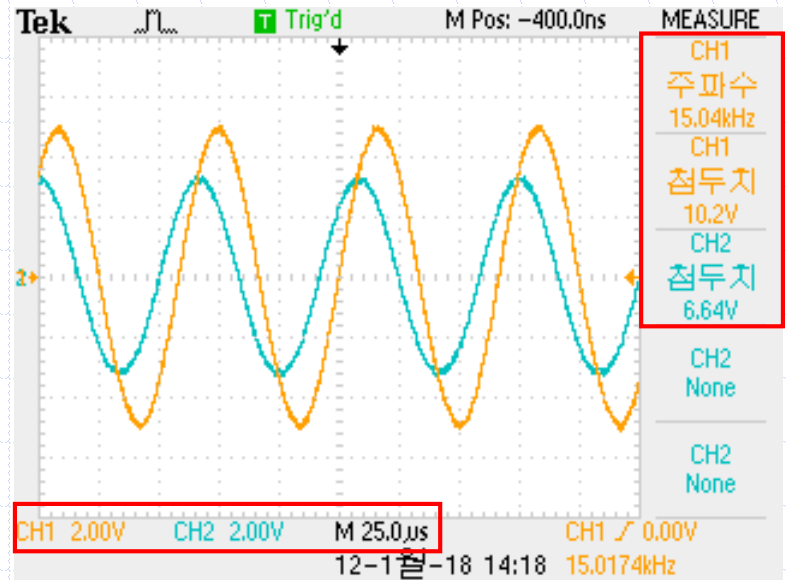
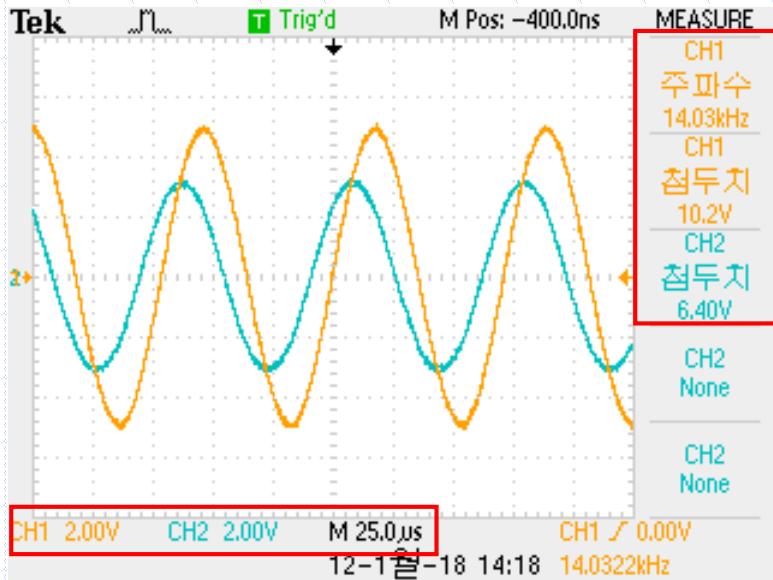

16-6. RL High Pass Filter-HPF

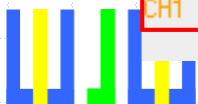
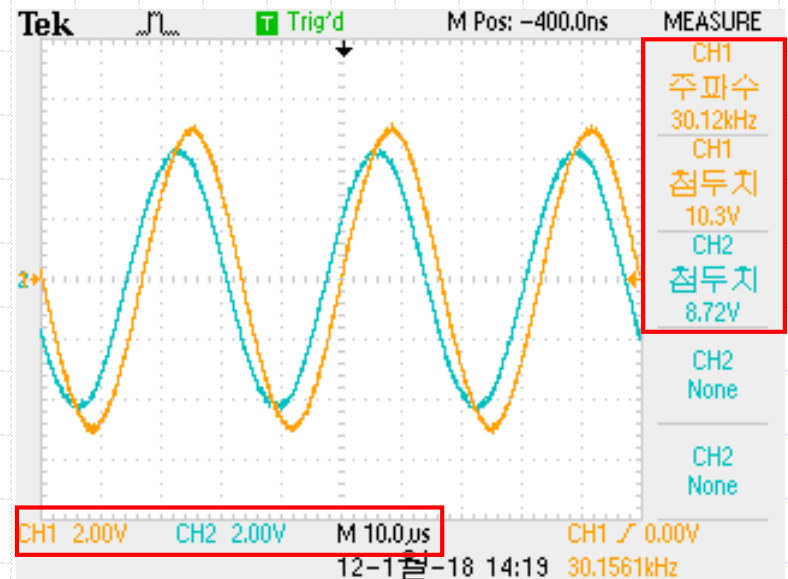
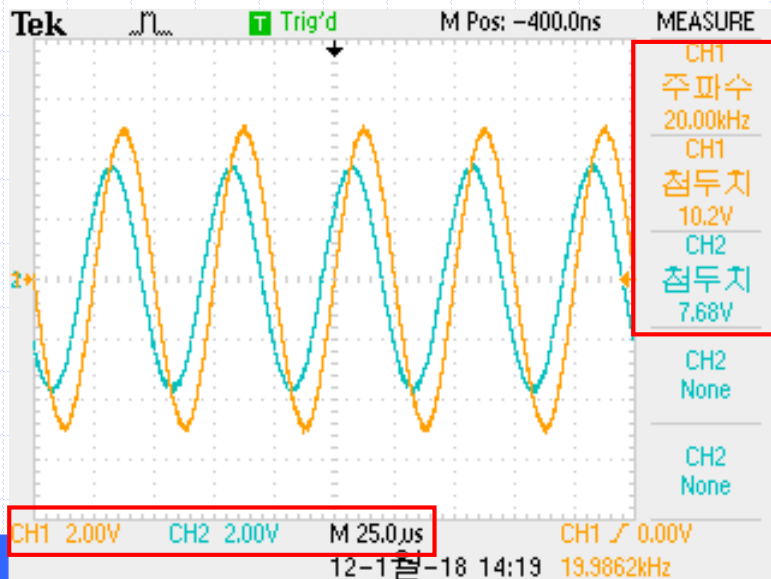
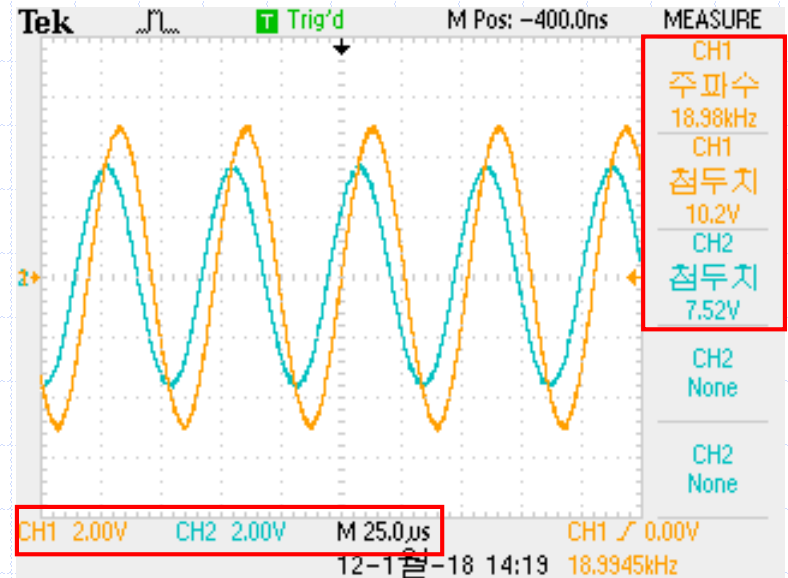
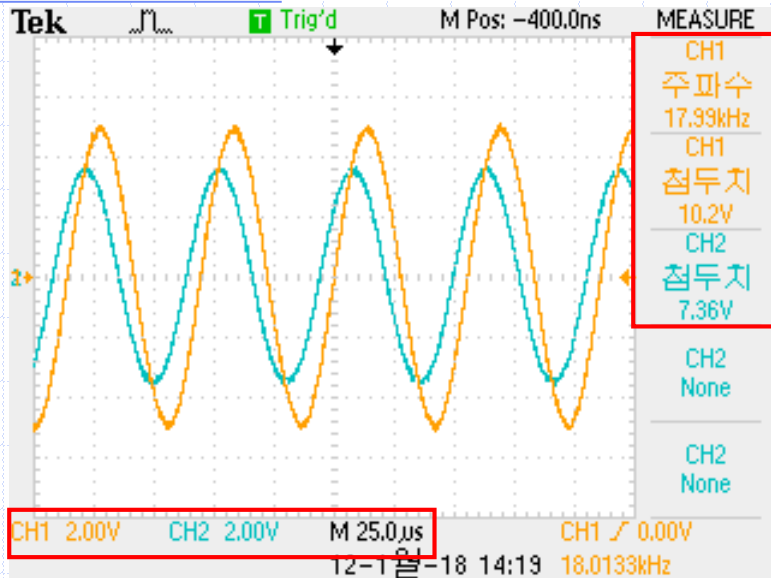

16-6. RL High Pass Filter-HPF

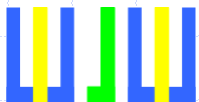
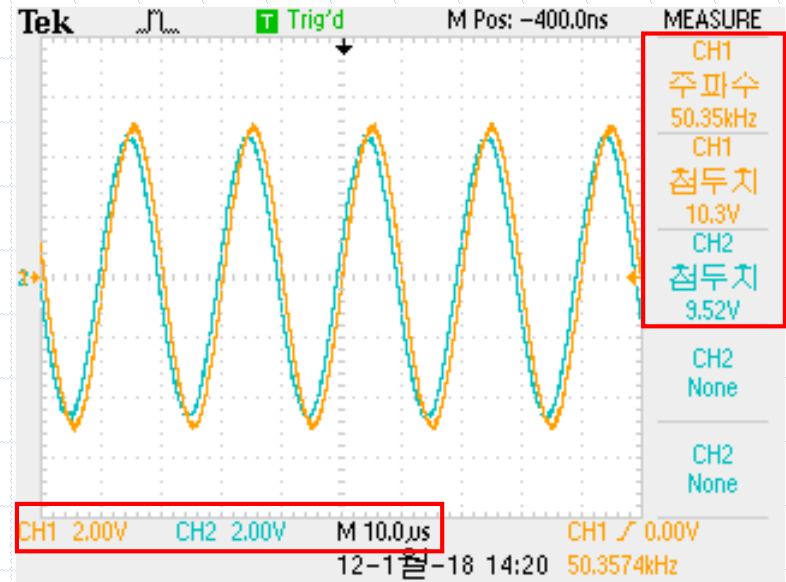
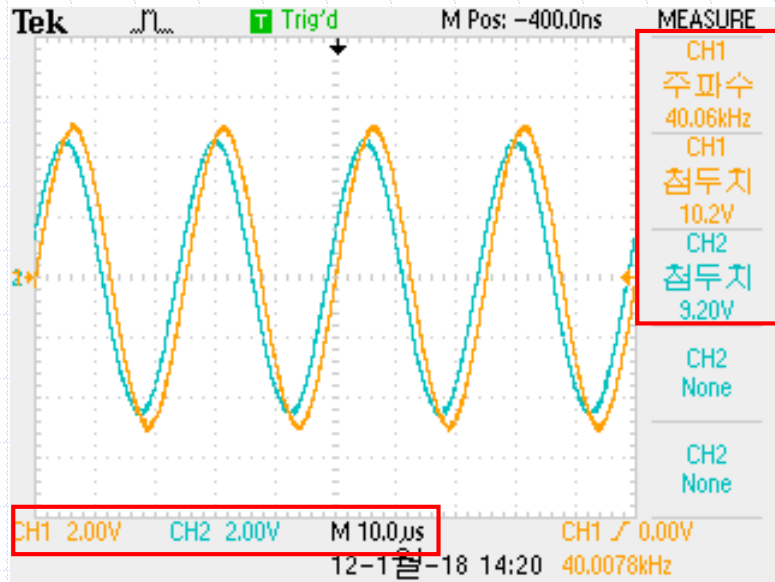

16-6. RL High Pass Filter-HPF

주파수 (kHz)	Vin [Vpp]	계산값			측정값		
		Vout [Vpp]	이득	이득 (dB)	Vout [Vpp]	이득	이득 (dB)
5	10	3.00	0.30	-10.47	3.12	0.312	-10.117
10	10	5.32	0.53	-5.48	5.20	0.520	-5.680
11	10	5.69	0.57	-4.90	5.52	0.552	-5.161
12	10	6.02	0.60	-4.41	5.84	0.584	-4.672
13	10	6.33	0.63	-3.98	6.16	0.616	-4.208
14	10	6.60	0.66	-3.60	6.40	0.640	-3.876
15	10	6.86	0.69	-3.28	6.64	0.664	-3.557
16	10	7.09	0.71	-2.99	6.88	0.688	-3.248
17	10	7.30	0.73	-2.73	7.12	0.712	-2.950
18	10	7.49	0.75	-2.51	7.36	0.736	-2.662
19	10	7.67	0.77	-2.31	7.52	0.752	-2.476
20	10	7.82	0.78	-2.13	7.68	0.768	-2.293
30	10	8.83	0.88	-1.08	8.72	0.872	-1.190
40	10	9.29	0.93	-0.64	9.20	0.920	-0.724
50	10	9.53	0.95	-0.42	9.52	0.952	-0.427

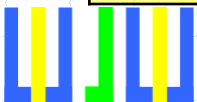

16-6. RL High Pass Filter-HPF

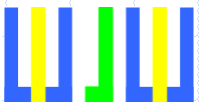
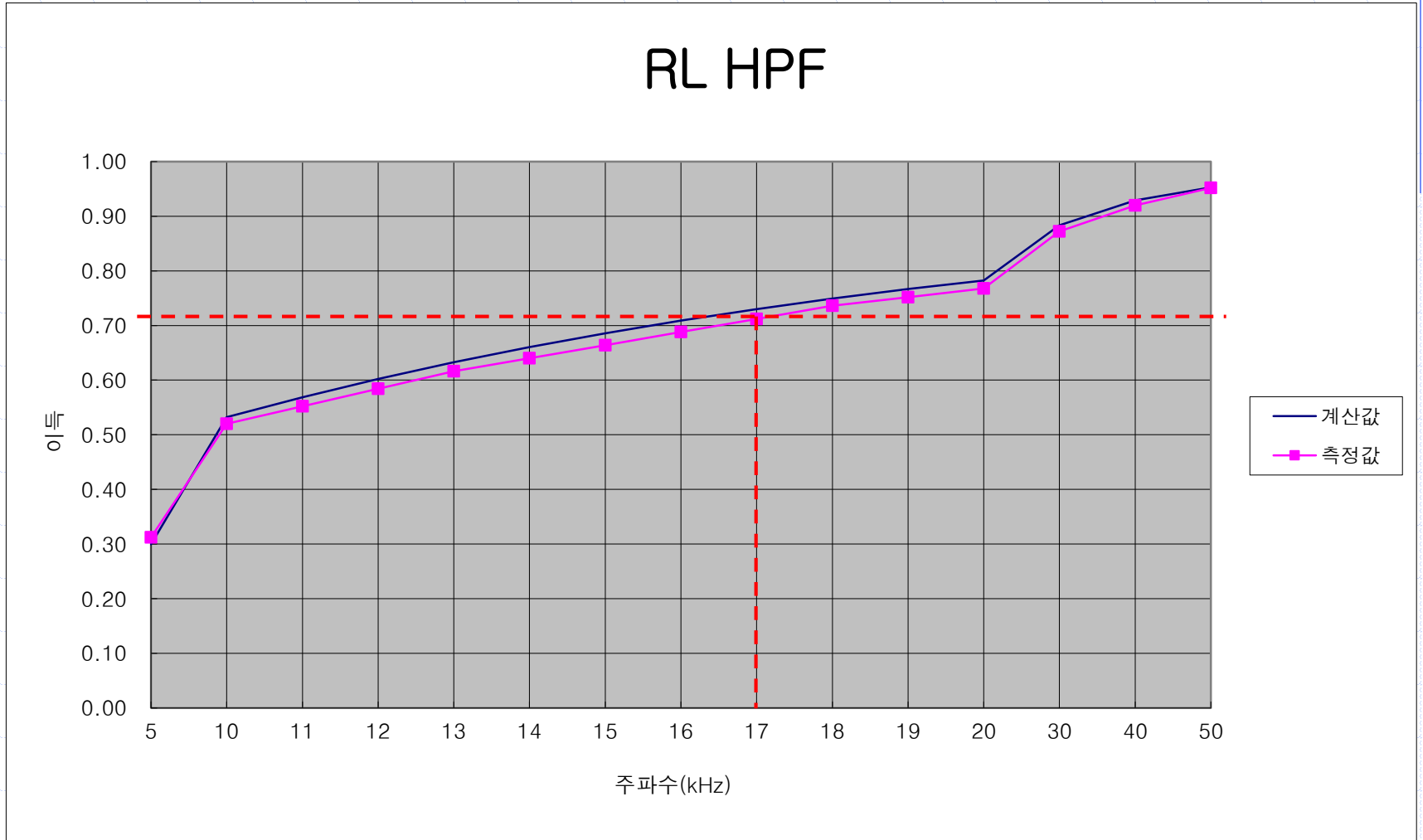

16-6. RL High Pass Filter-HPF

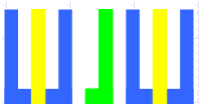
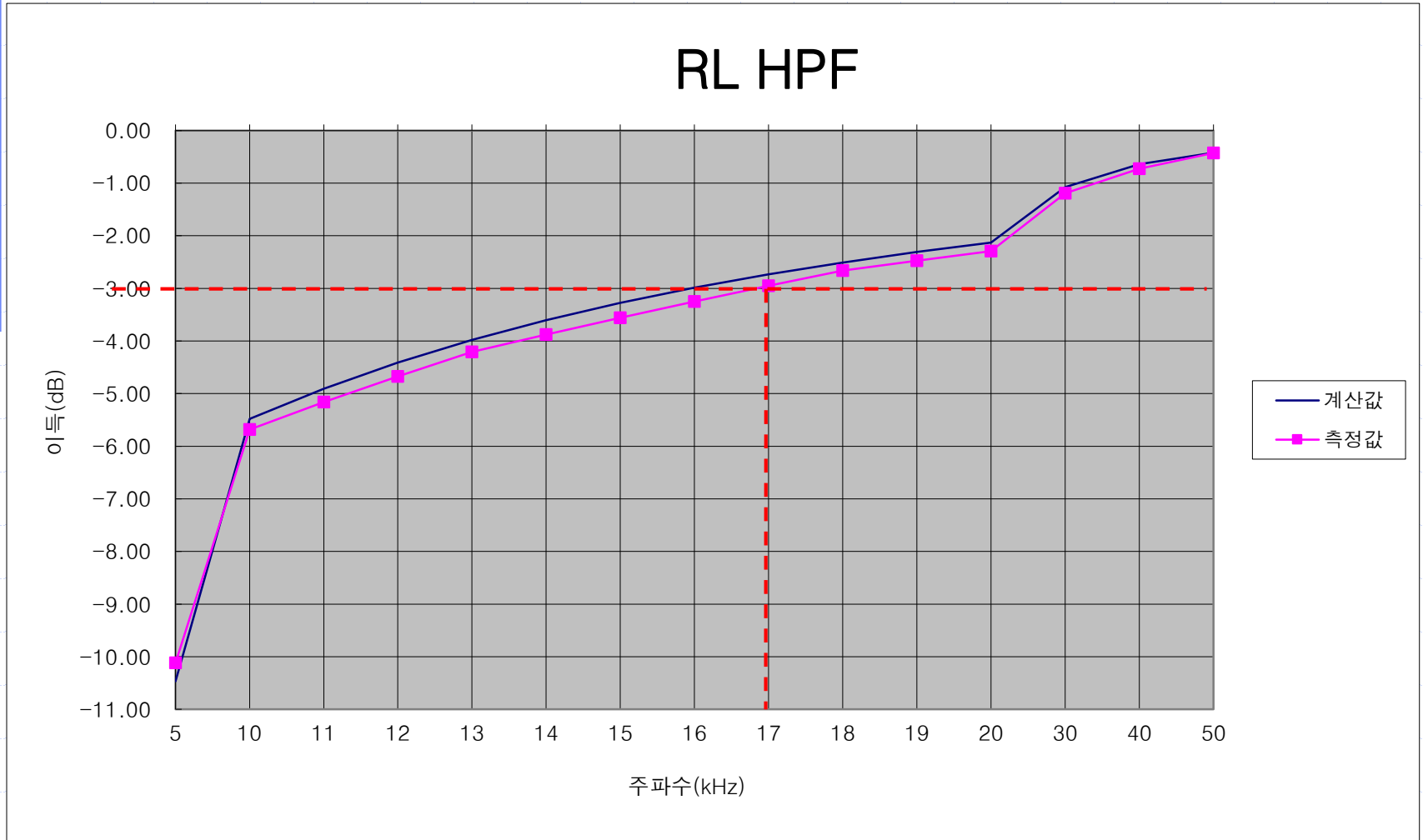

16-6. RL High Pass Filter-HPF

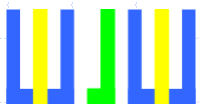
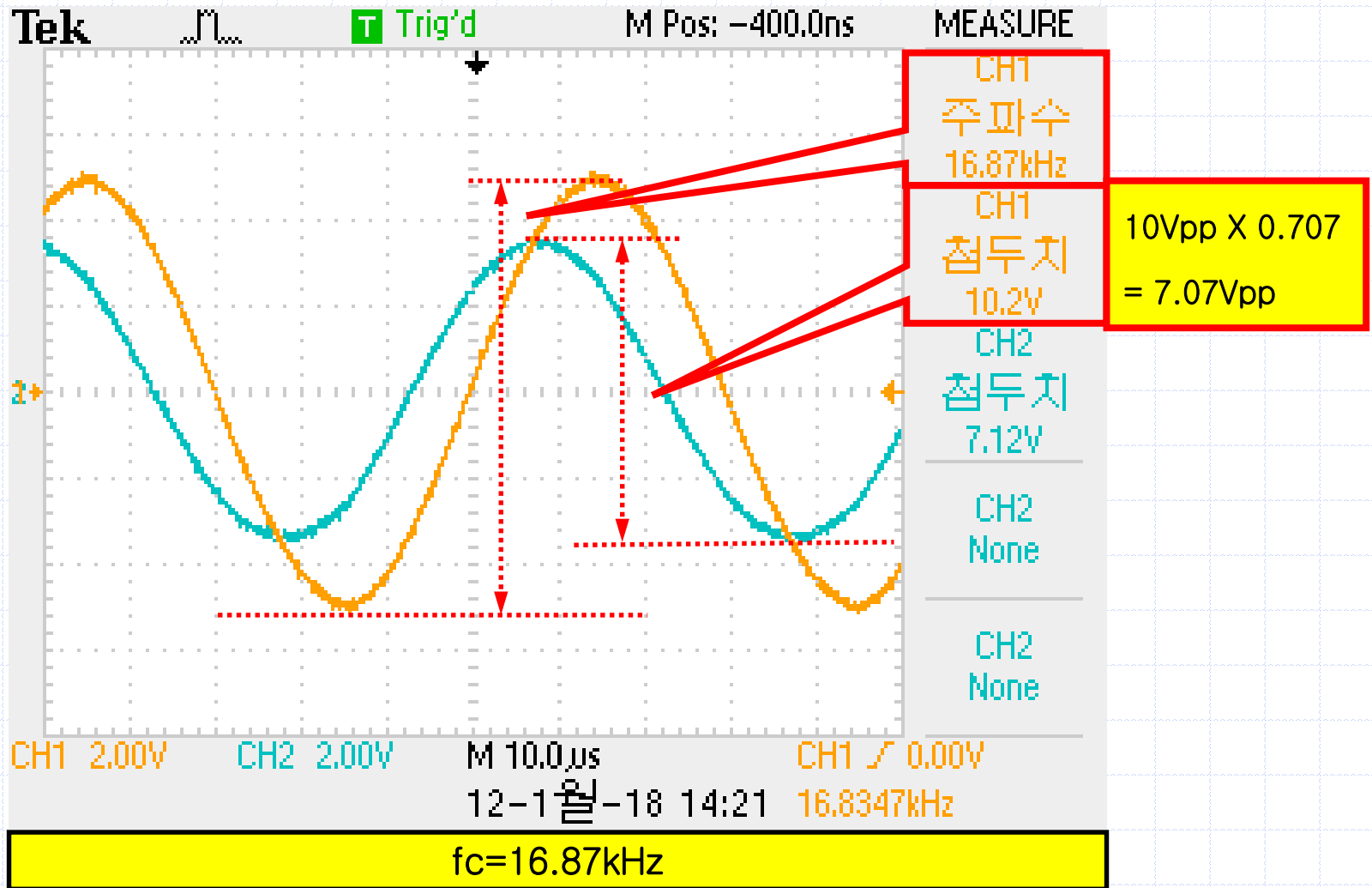

16-7. RC High Pass Filter-HPF

- ✓ 다음과 같이 회로를 연결하고, 신호발생기를 조절하여 주파수 500Hz, 10Vpp 의 정현파가 나오도록 한다.

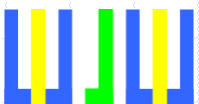
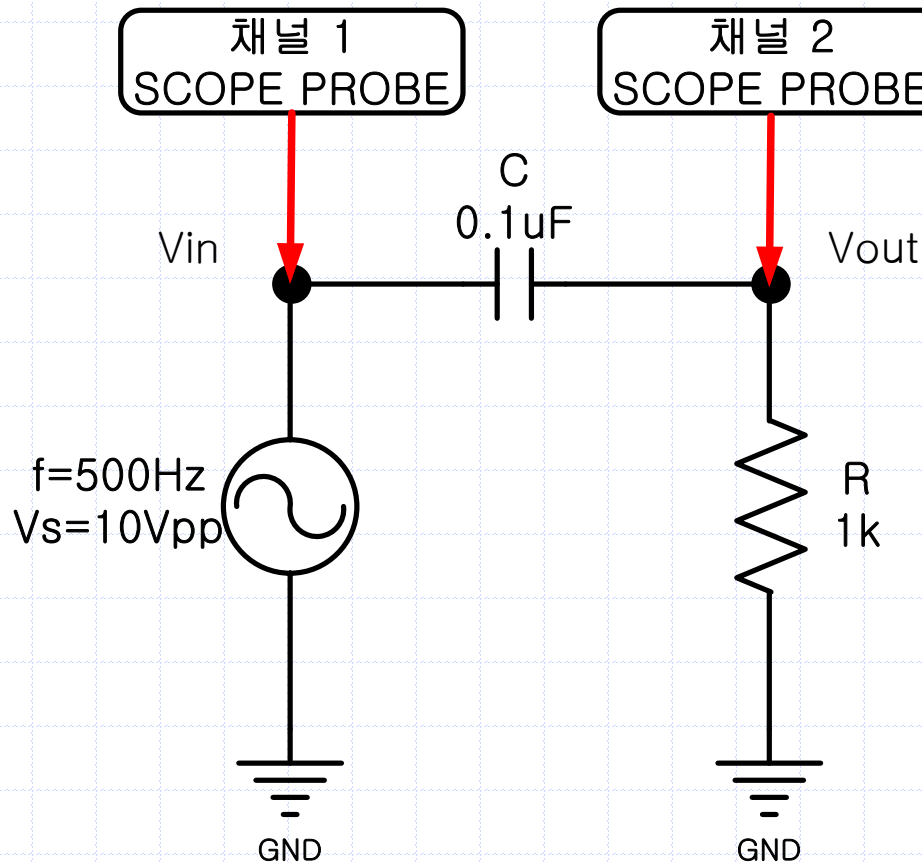

16-7. RC High Pass Filter-HPF

- ✓ 다음과 같이 회로를 연결하고, 신호발생기를 조절하여 주파수 500Hz, 10Vpp 의 정현파가 나오도록 한다.

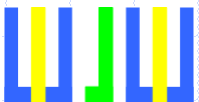
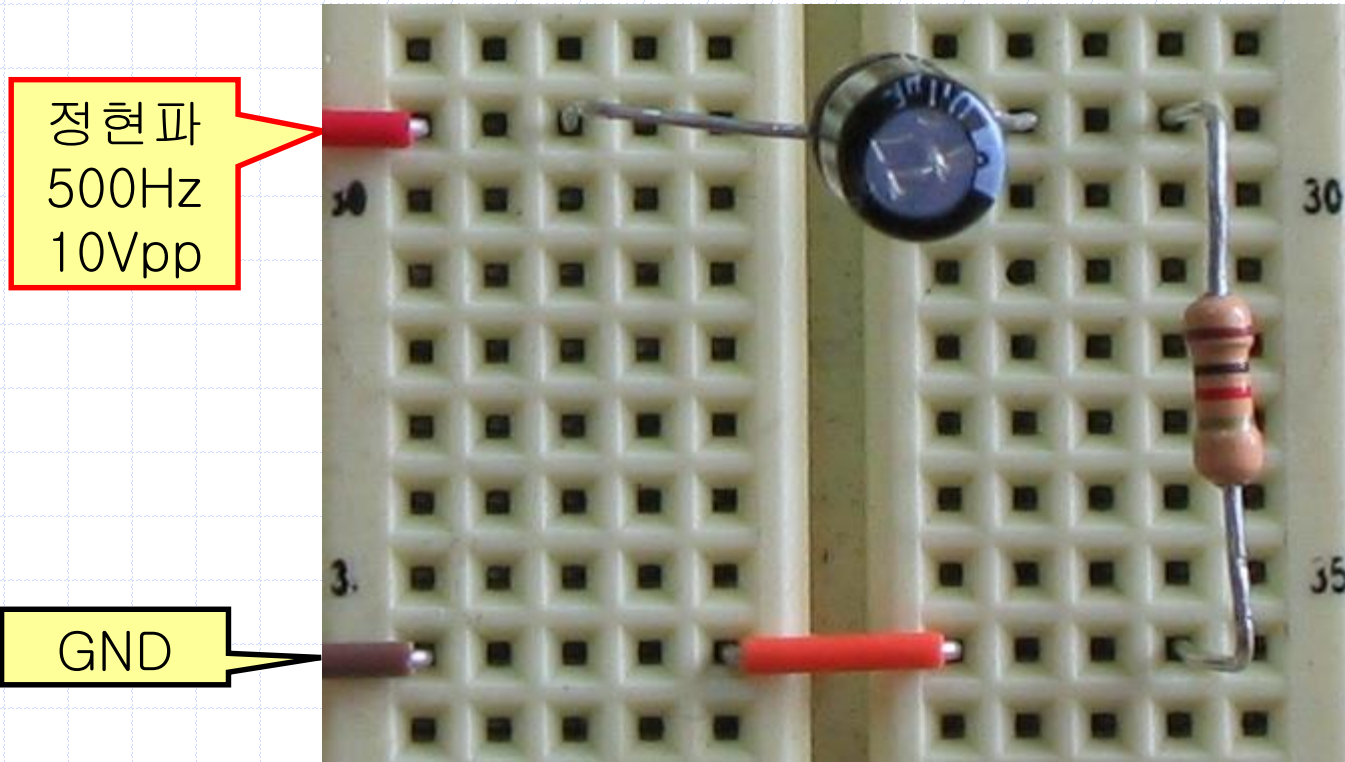

16-7. RC High Pass Filter-HPF

- ✓ 오실로스코프의 CH 1 을 이용하여 입력 전압(V_{in})을 측정하고, CH 2는 출력 전압(V_{out})을 측정한다.

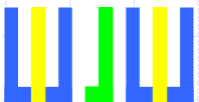
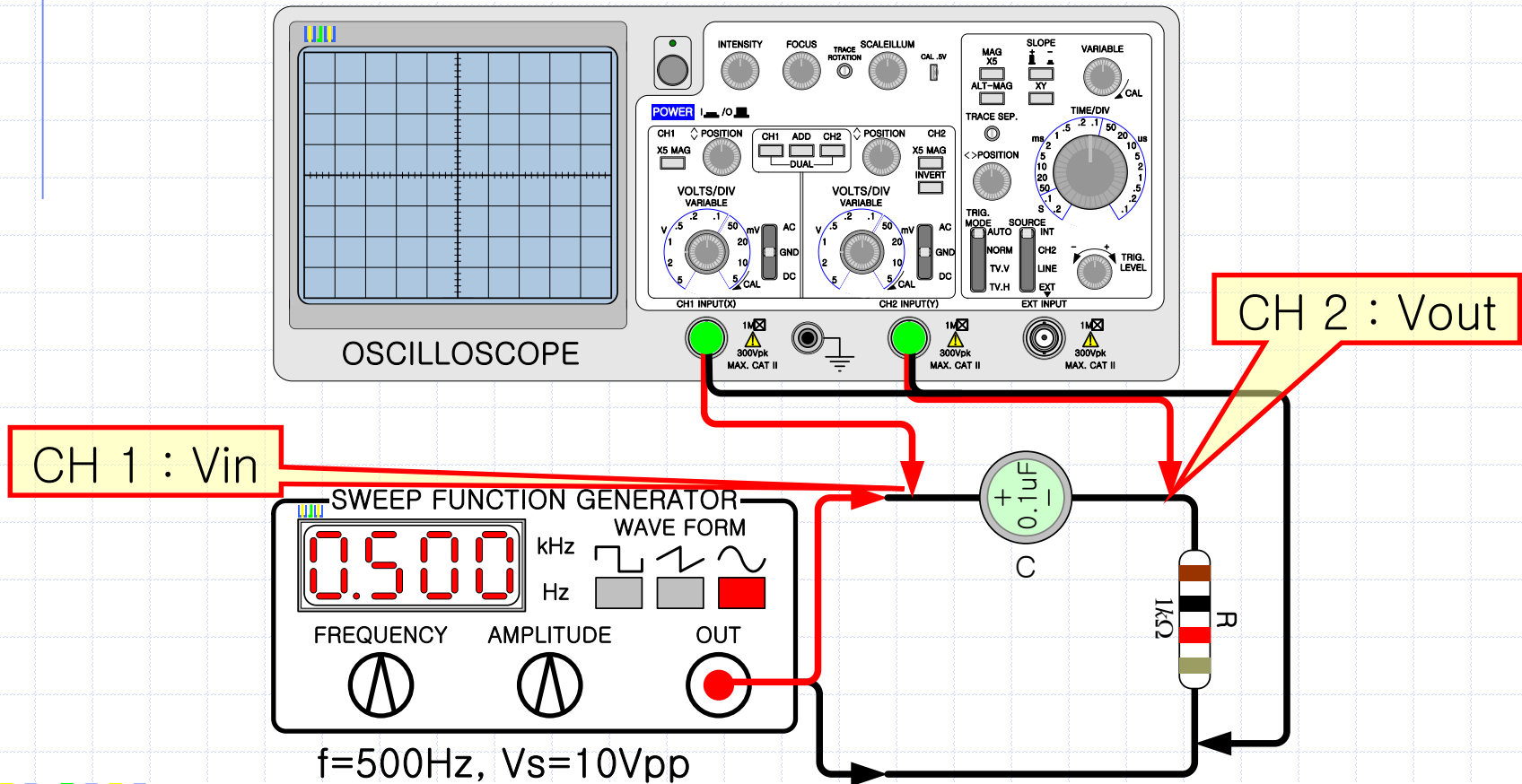

16-7. RC High Pass Filter-HPF

✓ 주파수 : 500Hz

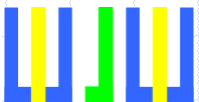
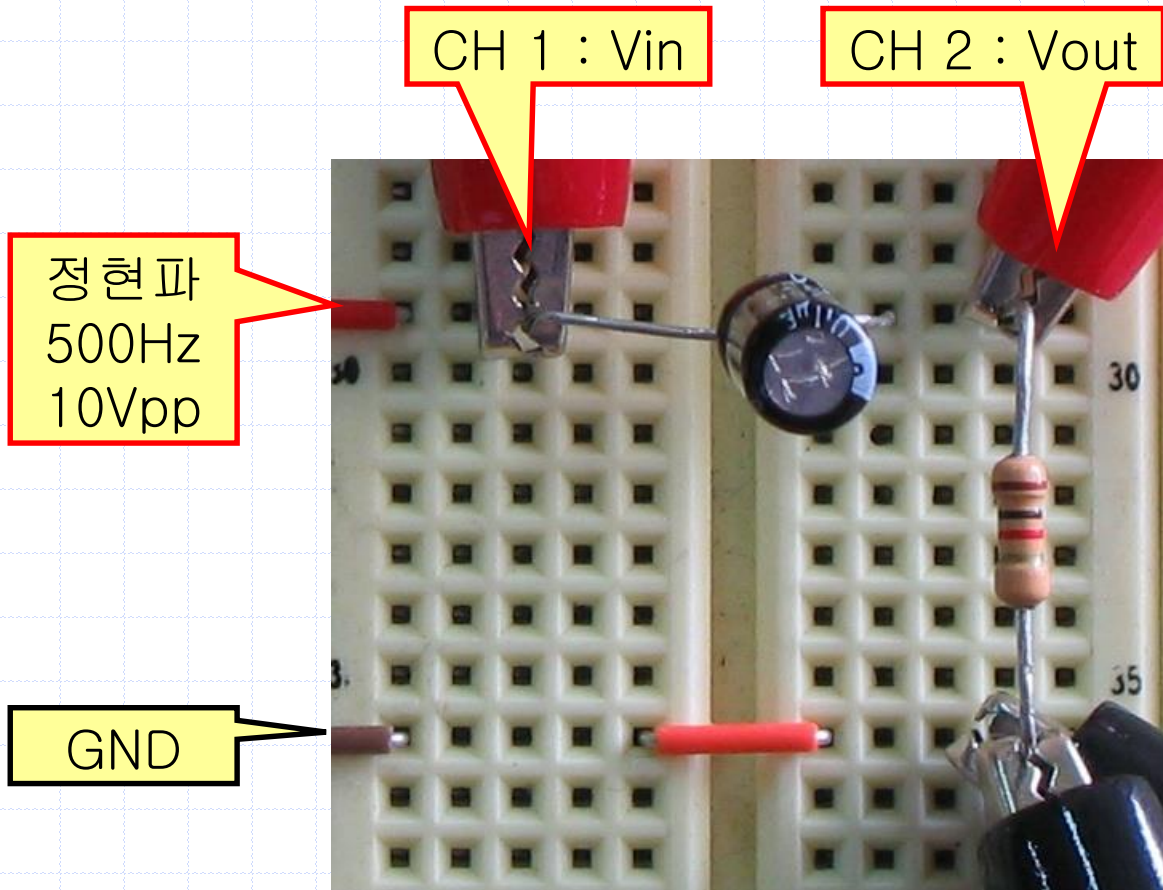

16-7. RC High Pass Filter-HPF

✓ 주파수 : 500Hz

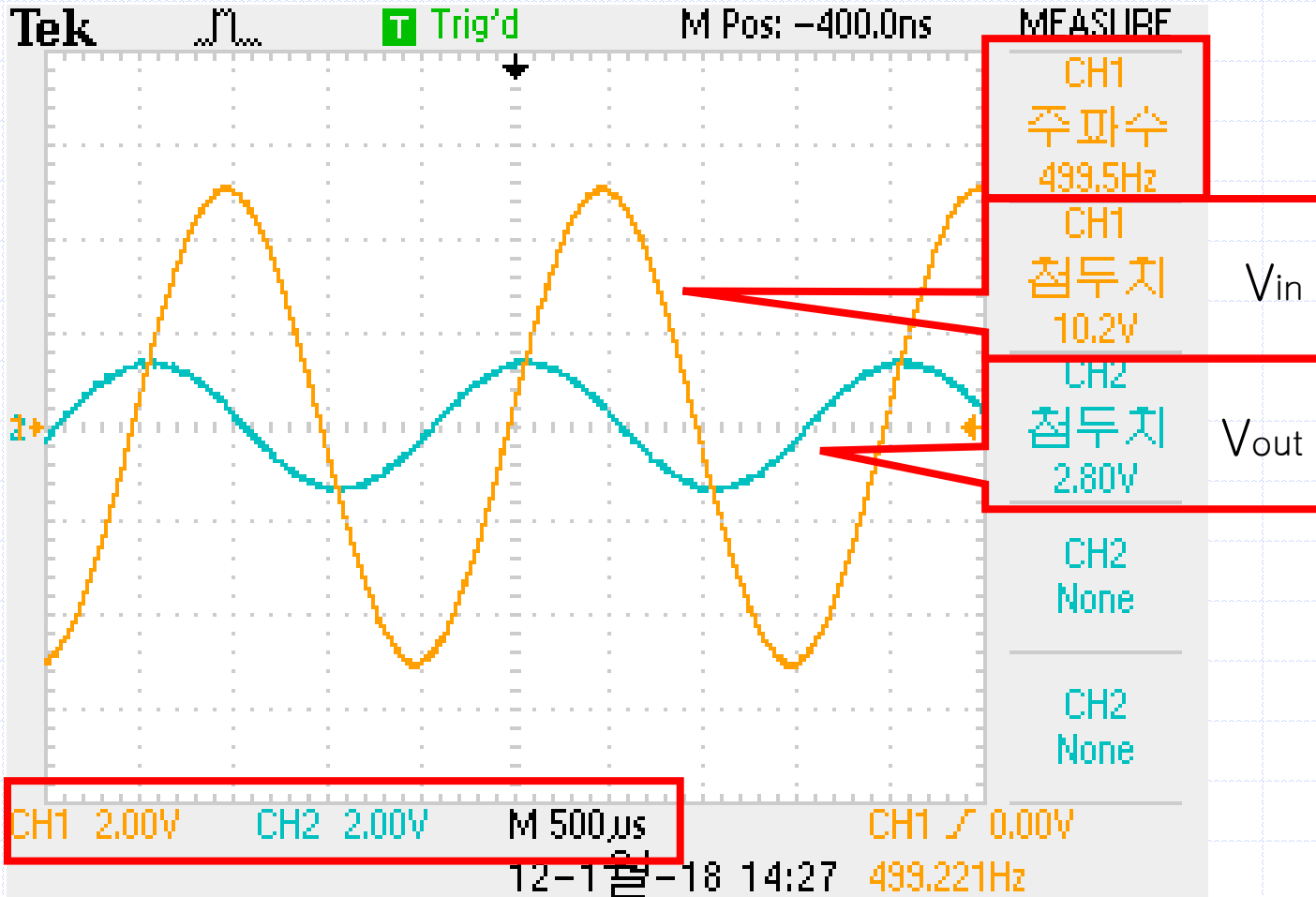

CH 1 : 2V/DIV, CH 2 : 2V/DIV, Time : 500uS/DIV

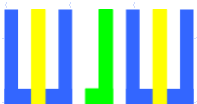

16-7. RC High Pass Filter-HPF

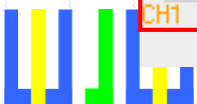
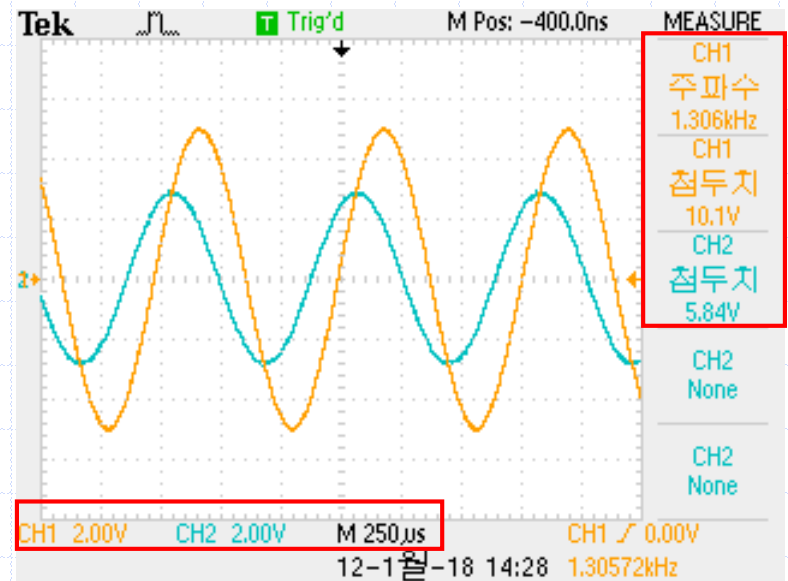
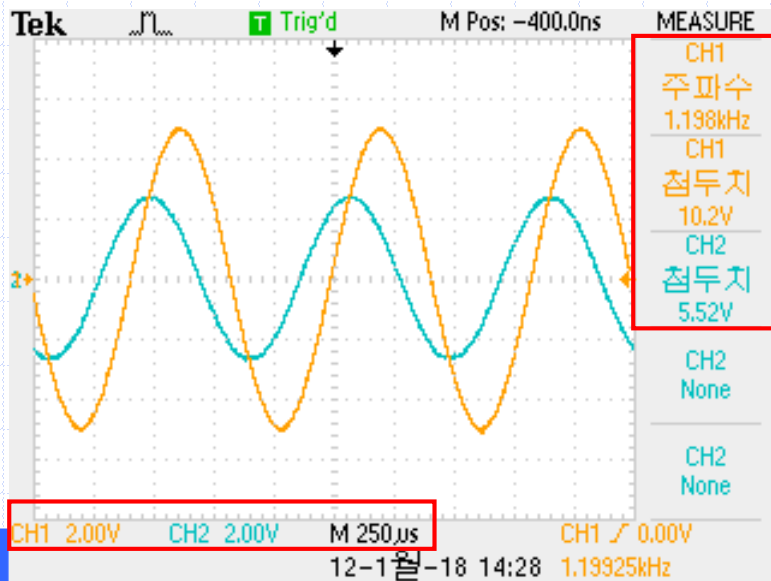
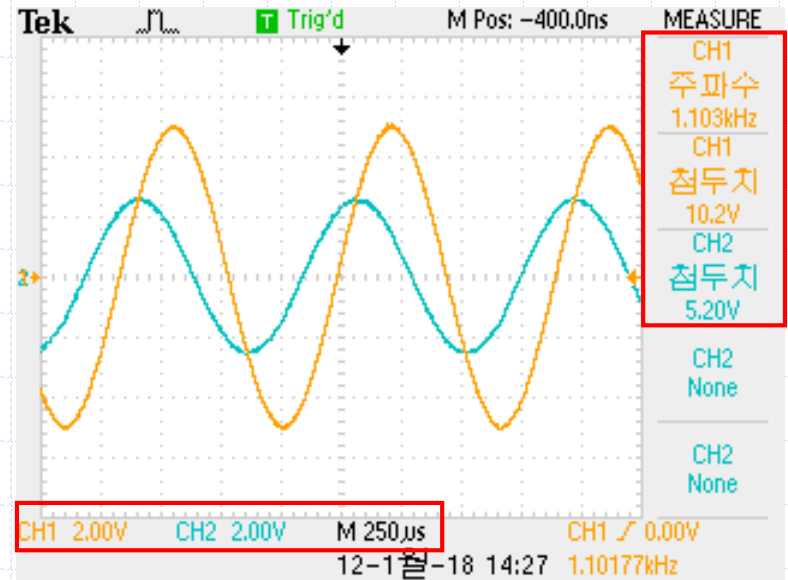
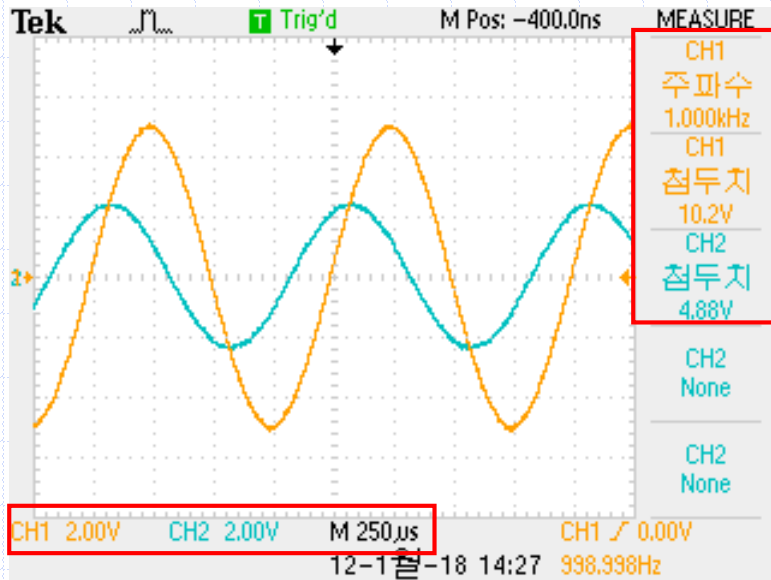

16-7. RC High Pass Filter-HPF

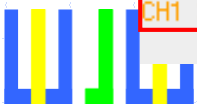
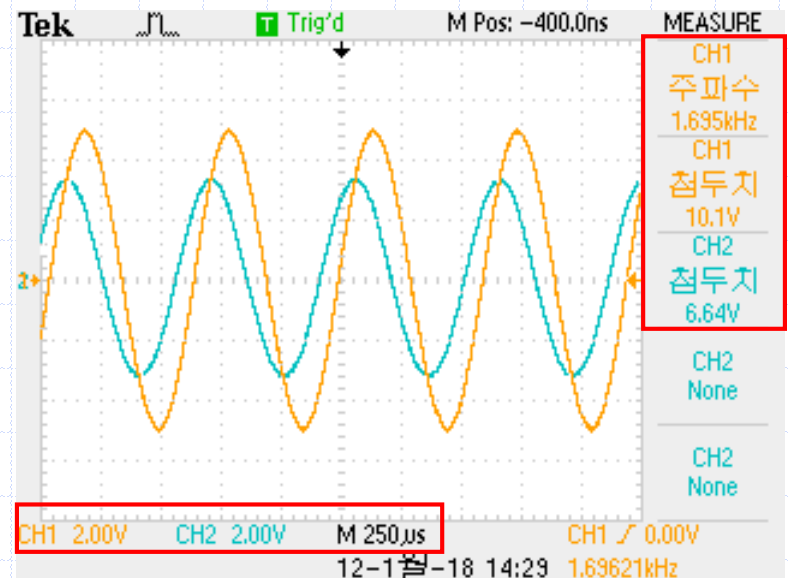
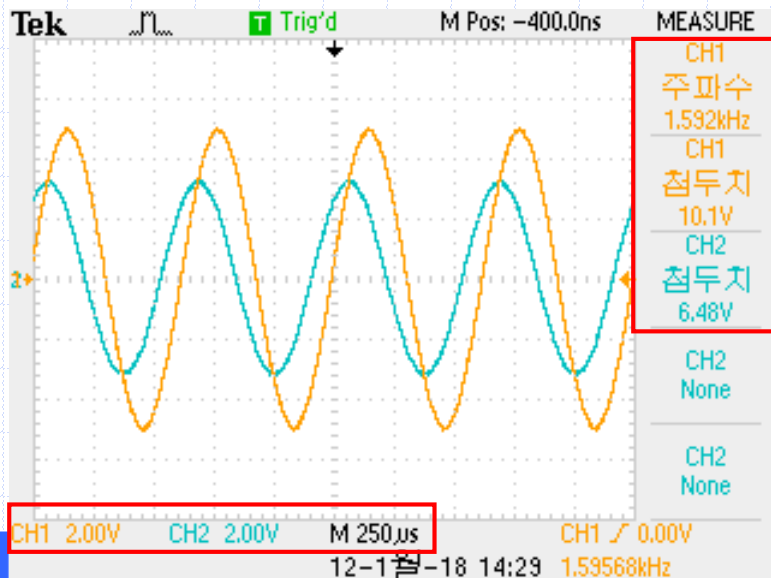
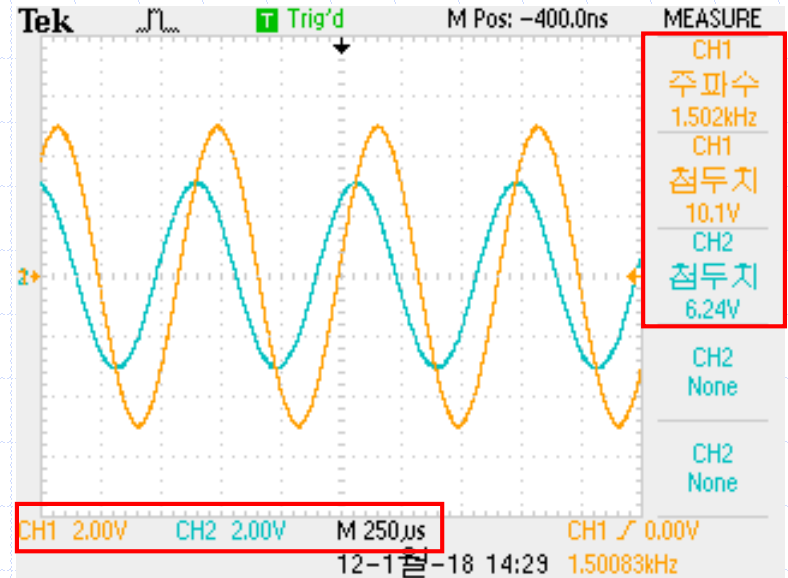
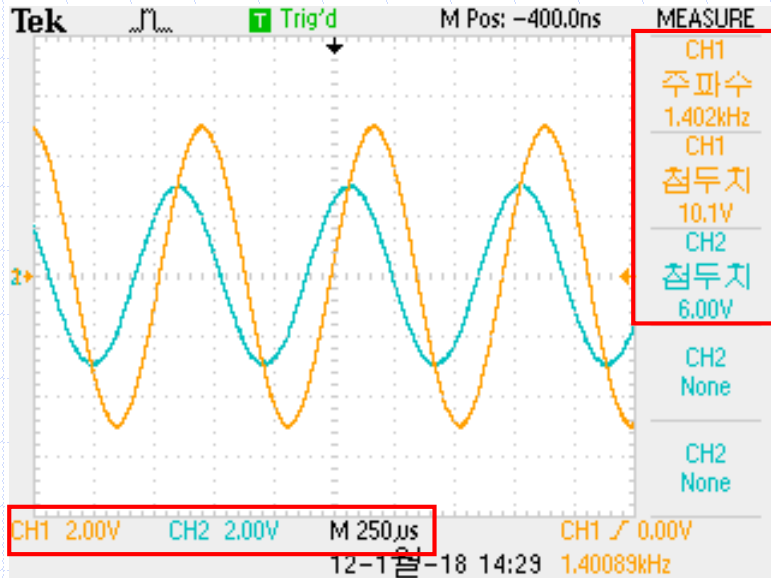

16-7. RC High Pass Filter-HPF

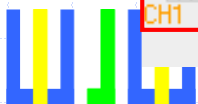
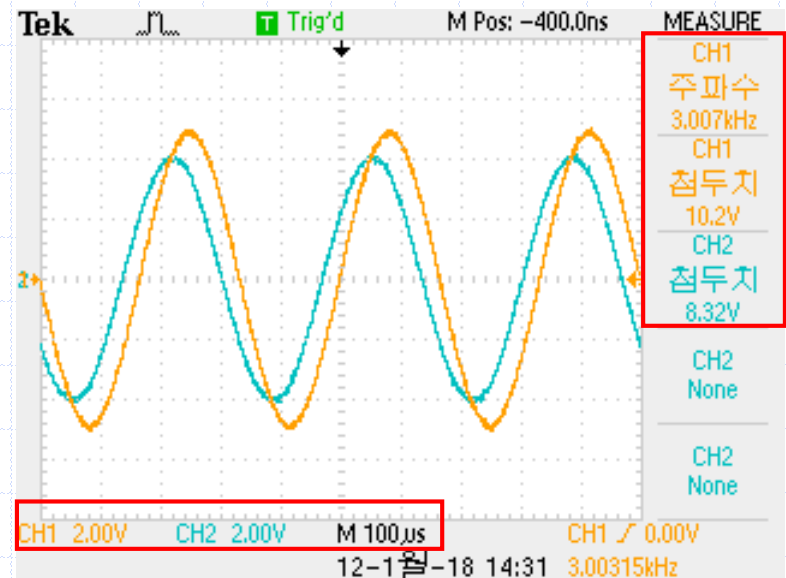
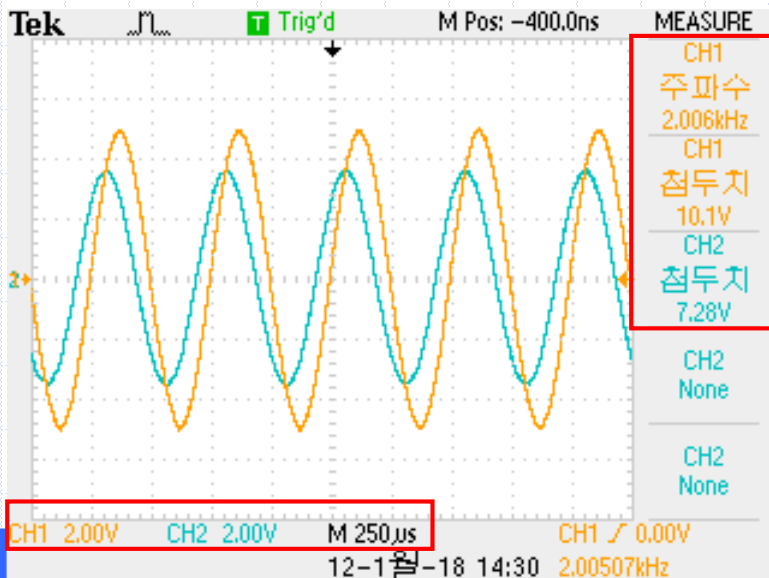
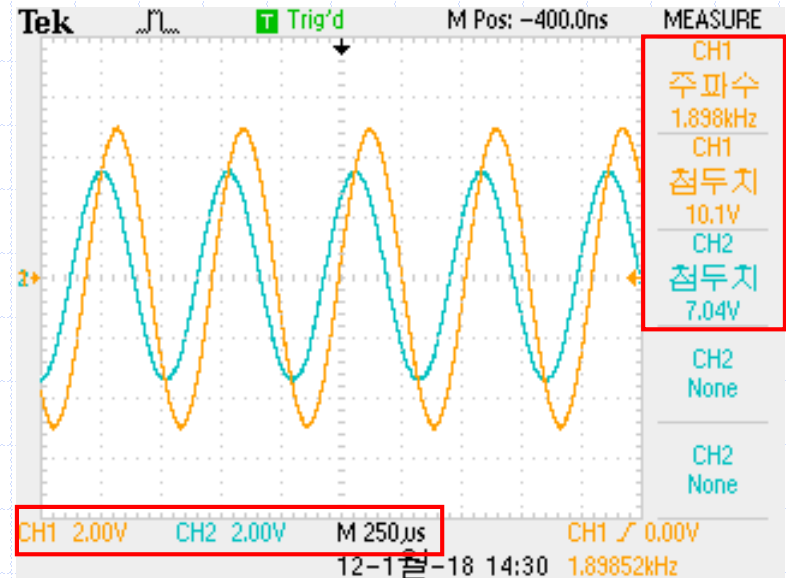
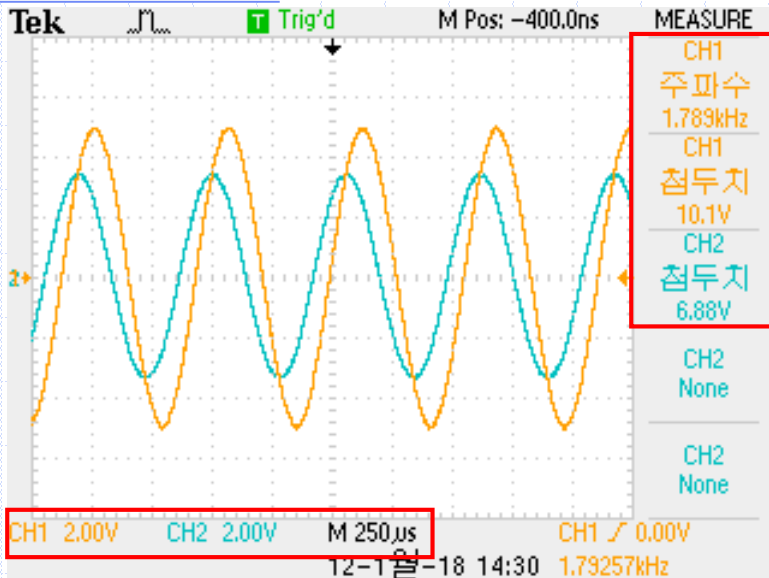

16-7. RC High Pass Filter-HPF

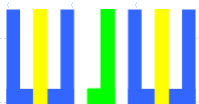
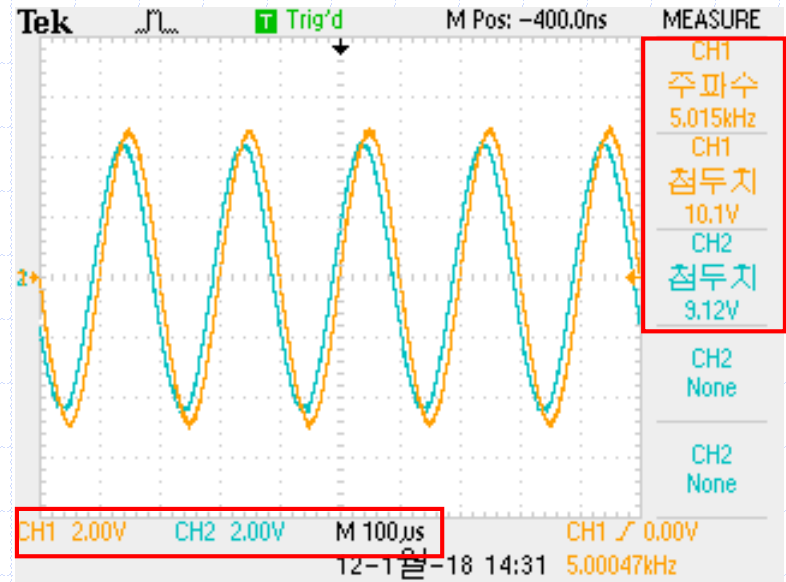
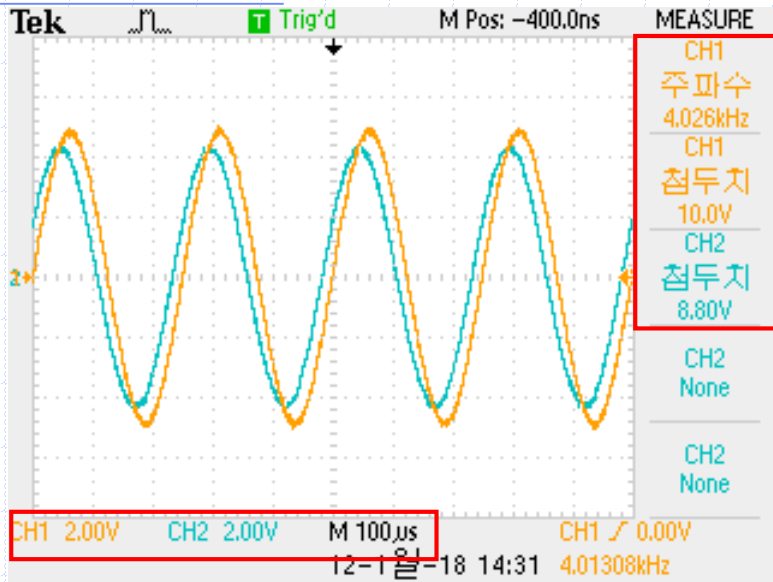

16-7. RC High Pass Filter-HPF

주파수 (Hz)	Vin [Vpp]	계산값			측정값		
		Vout [Vpp]	이득	이득 (dB)	Vout [Vpp]	이득	이득 (dB)
500	10	3.00	0.30	-10.47	2.80	0.280	-11.057
1,000	10	5.32	0.53	-5.48	4.88	0.488	-6.232
1,100	10	5.69	0.57	-4.90	5.20	0.520	-5.680
1,200	10	6.02	0.60	-4.41	5.52	0.552	-5.161
1,300	10	6.33	0.63	-3.98	5.84	0.584	-4.672
1,400	10	6.60	0.66	-3.60	6.00	0.600	-4.437
1,500	10	6.86	0.69	-3.28	6.24	0.624	-4.096
1,600	10	7.09	0.71	-2.99	6.48	0.648	-3.768
1,700	10	7.30	0.73	-2.73	6.64	0.664	-3.557
1,800	10	7.49	0.75	-2.51	6.88	0.688	-3.248
1,900	10	7.67	0.77	-2.31	7.04	0.704	-3.049
2,000	10	7.82	0.78	-2.13	7.28	0.728	-2.757
3,000	10	8.83	0.88	-1.08	8.32	0.832	-1.598
4,000	10	9.29	0.93	-0.64	8.80	0.880	-1.110
5,000	10	9.53	0.95	-0.42	9.12	0.912	-0.800

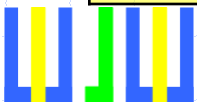

16-7. RC High Pass Filter-HPF

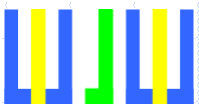
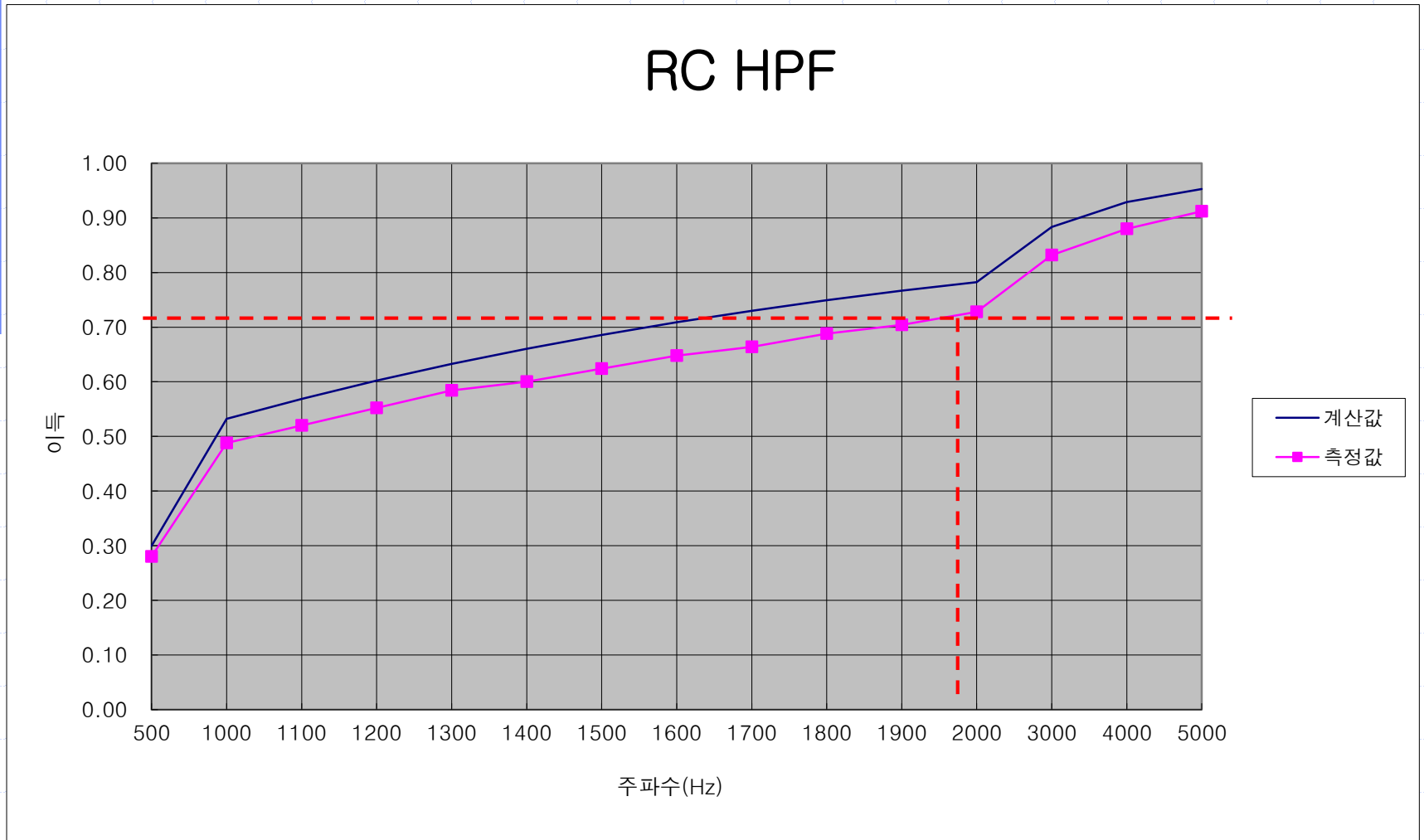

16-7. RC High Pass Filter-HPF

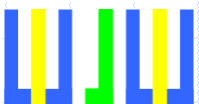
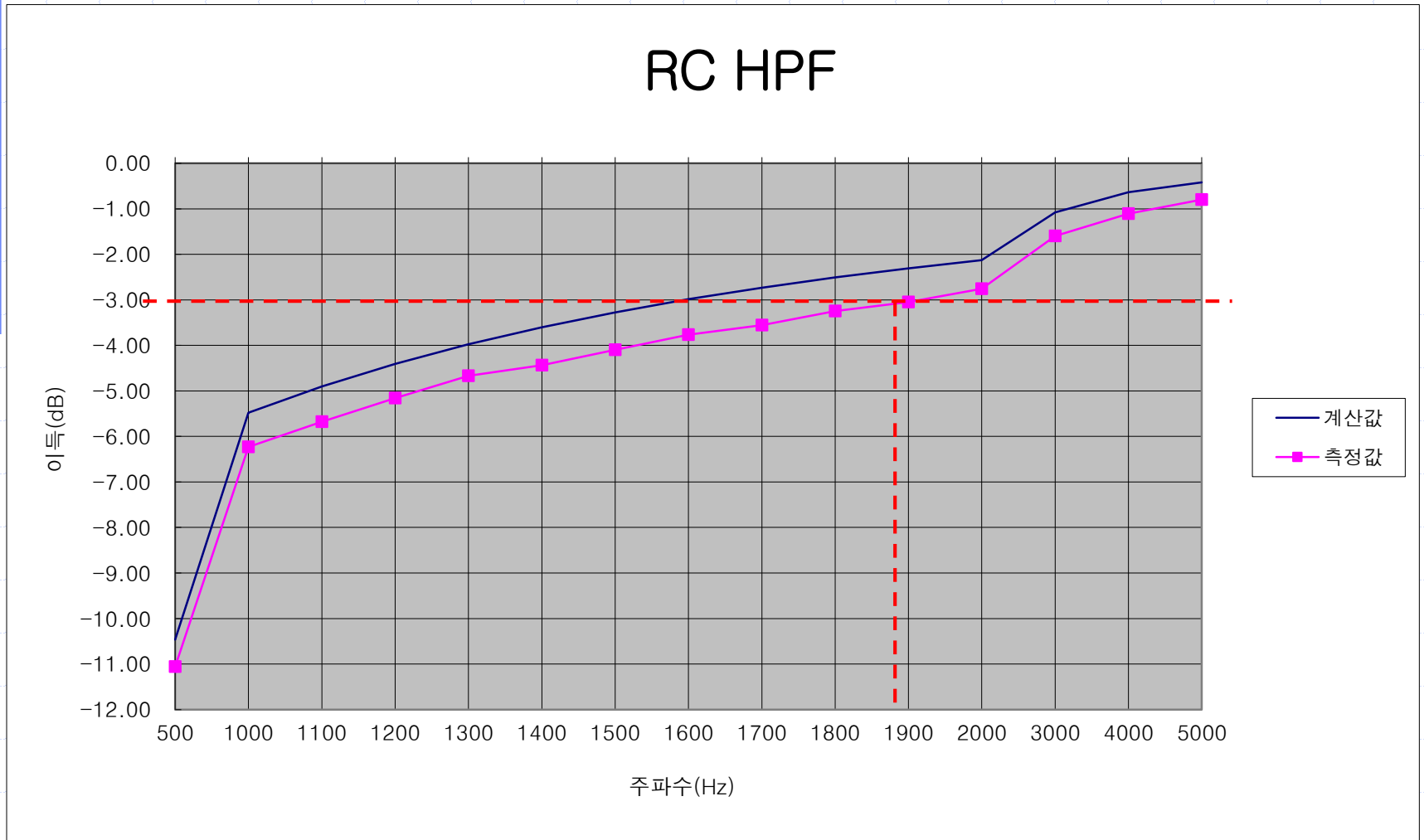

16-7. RC High Pass Filter-HPF

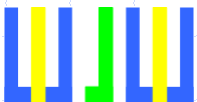
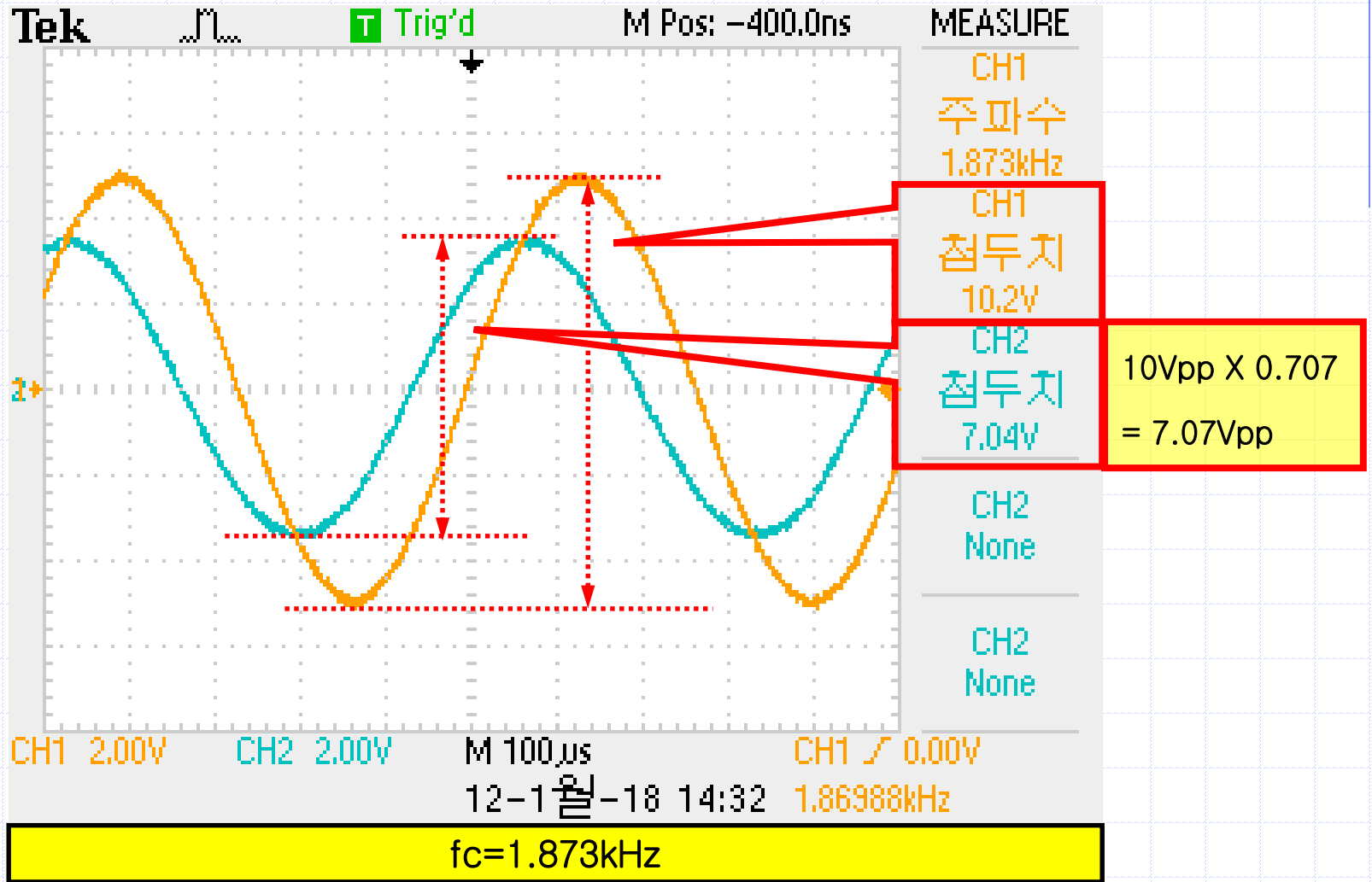

16-8. Band Pass Filter-BPF

- 다음과 같이 회로를 연결하고, 신호발생기를 조절하여 주파수 5kHz, 10Vpp 의 정현파가 나오도록 한다.

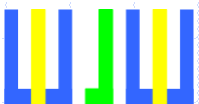
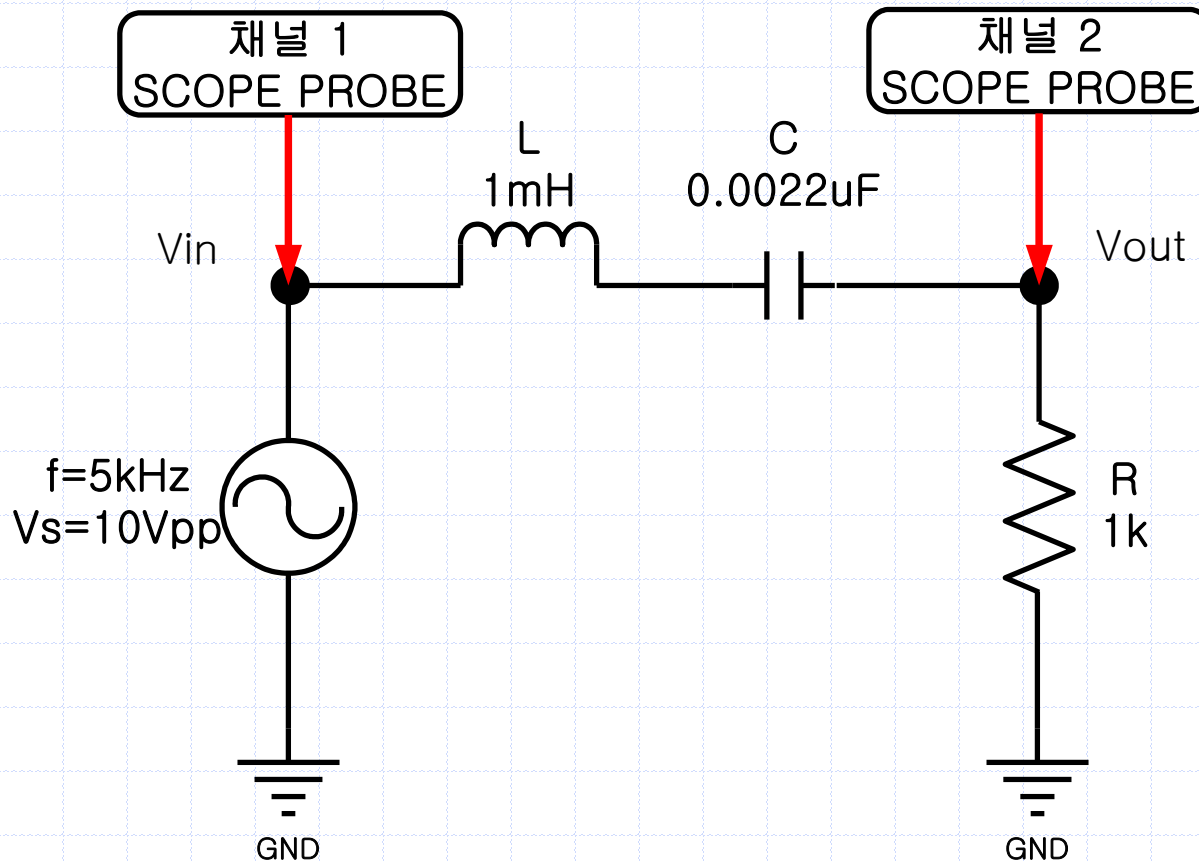

16-8. Band Pass Filter-BPF

- ✓ 다음과 같이 회로를 연결하고, 신호발생기를 조절하여 주파수 5kHz, 10Vpp 의 정현파가 나오도록 한다.

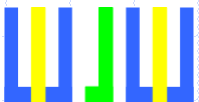
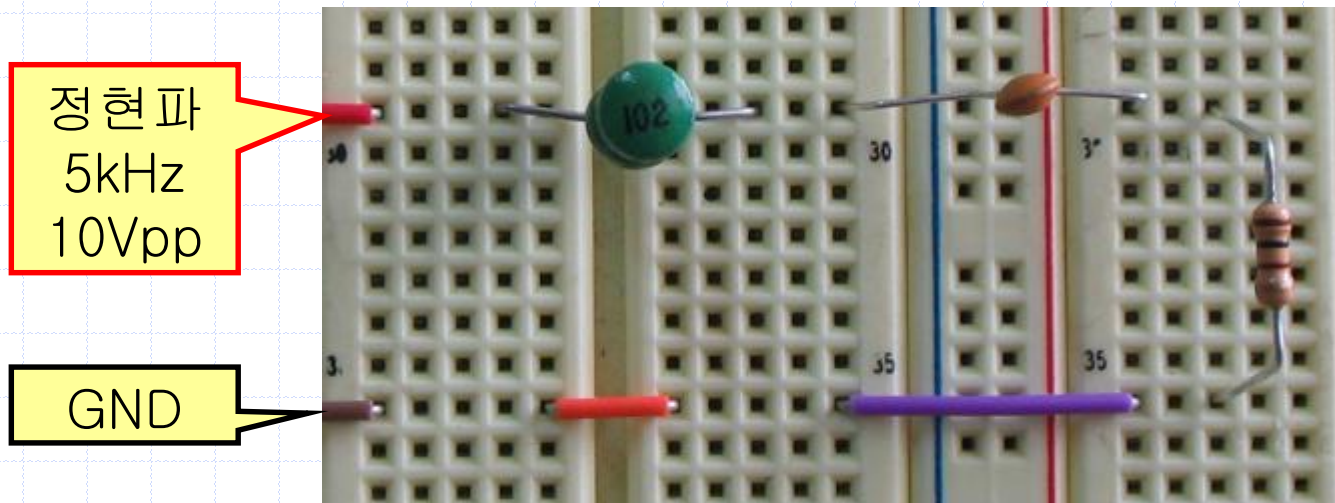

16-8. Band Pass Filter-BPF

- ✓ 오실로스코프의 CH 1 을 이용하여 입력 전압(V_{in})을 측정하고, CH 2는 출력 전압(V_{out})을 측정한다.

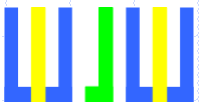
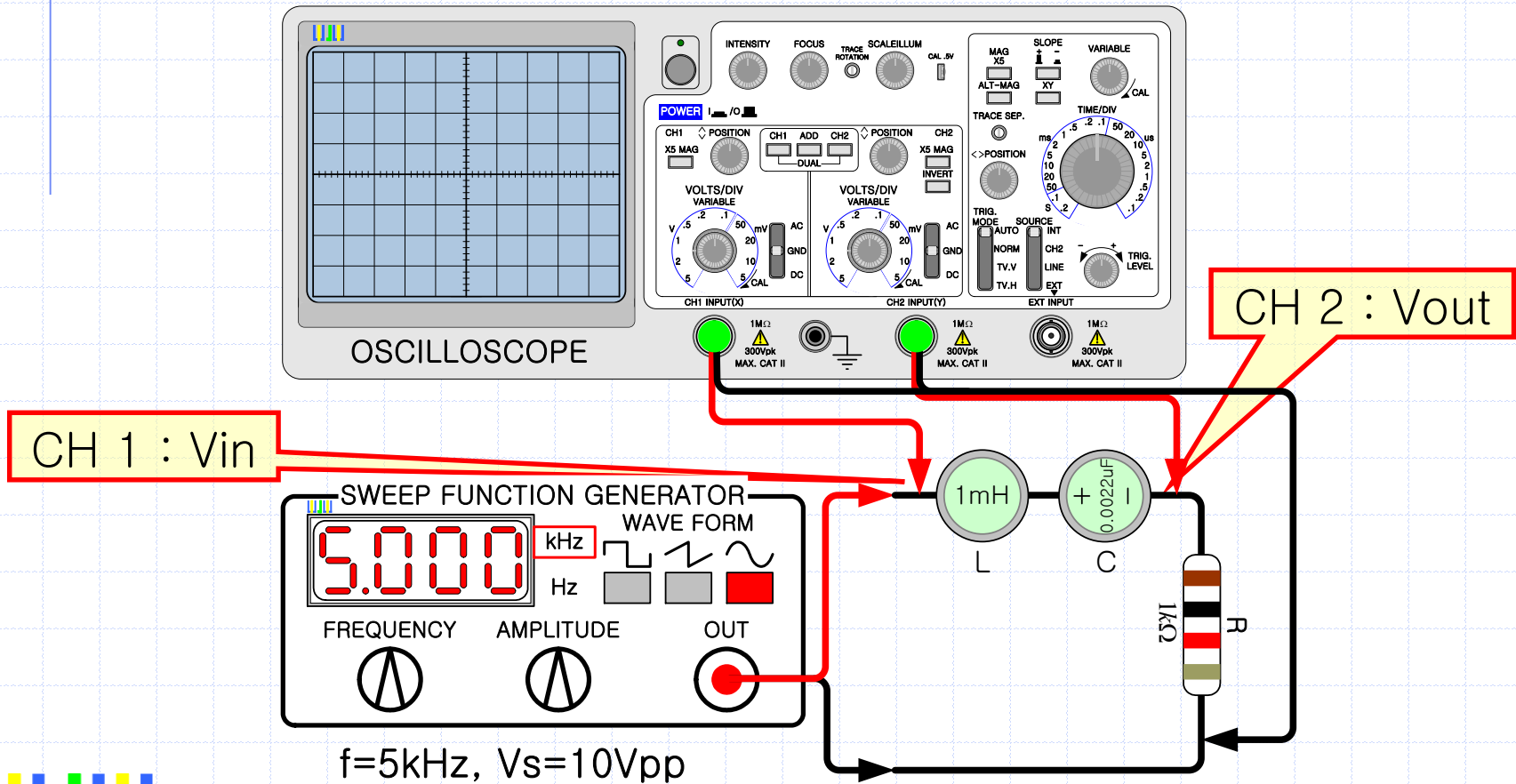

16-8. Band Pass Filter-BPF

✓ 주파수 : 5kHz

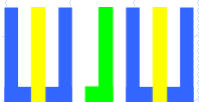
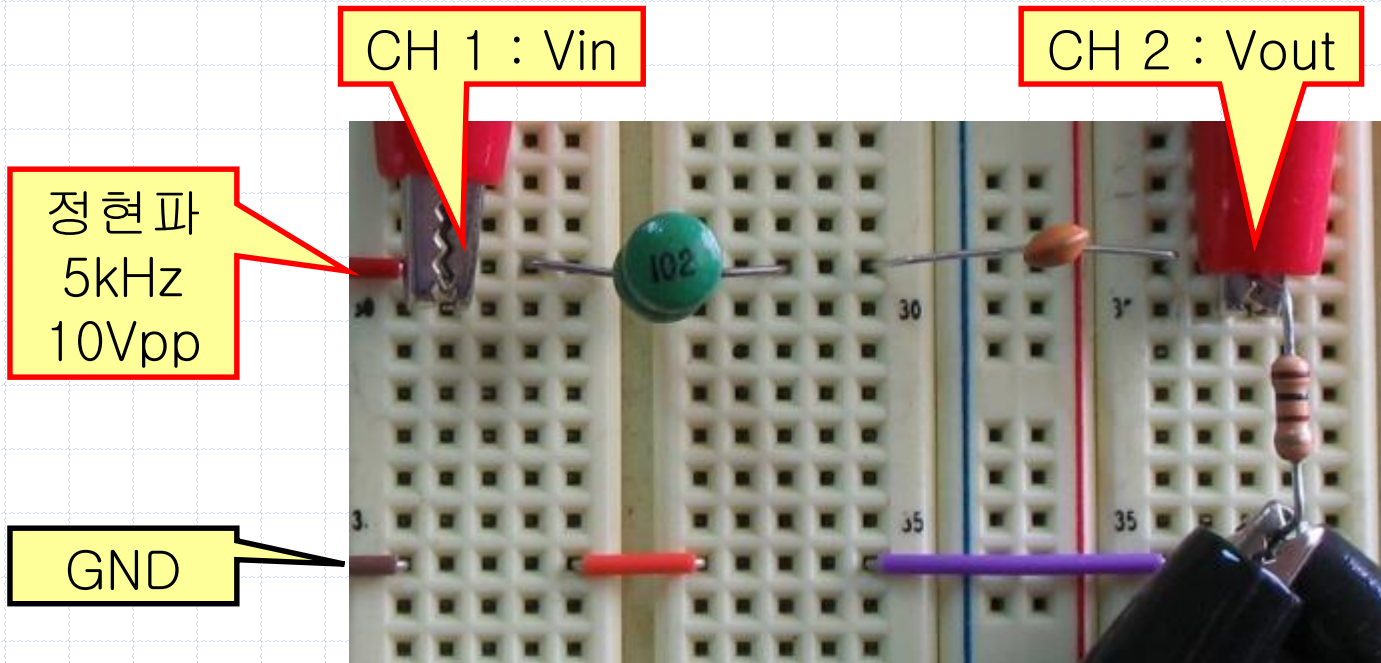

16-8. Band Pass Filter-BPF

✓ 주파수 : 5kHz

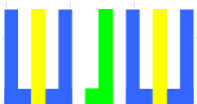
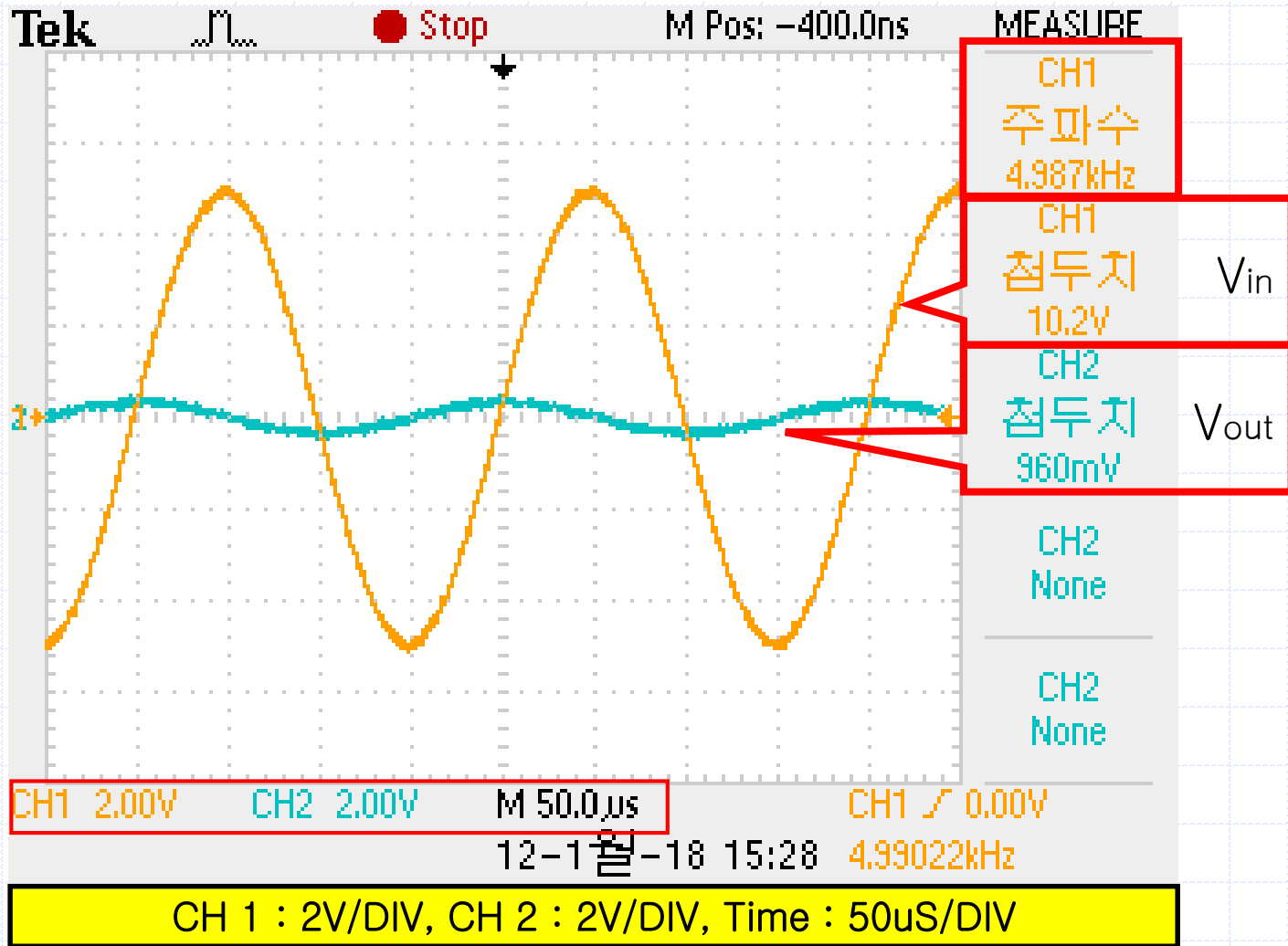

16-8. Band Pass Filter-BPF

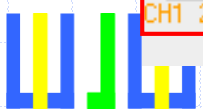
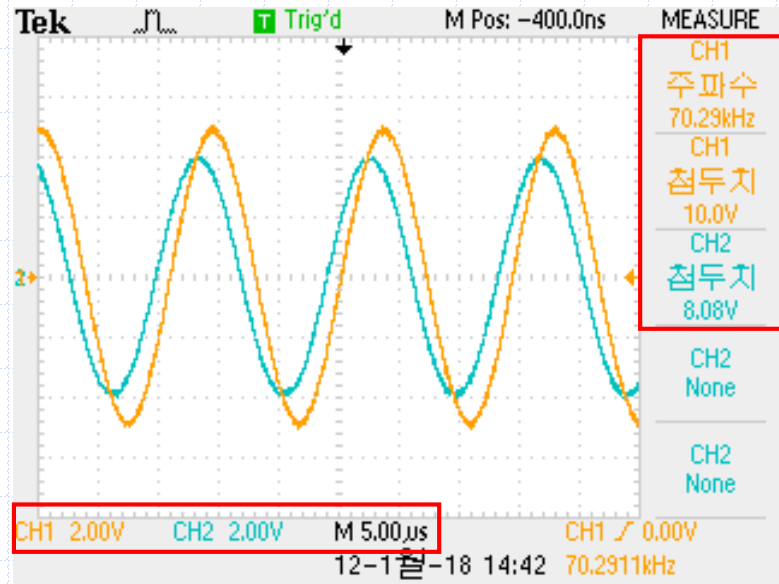
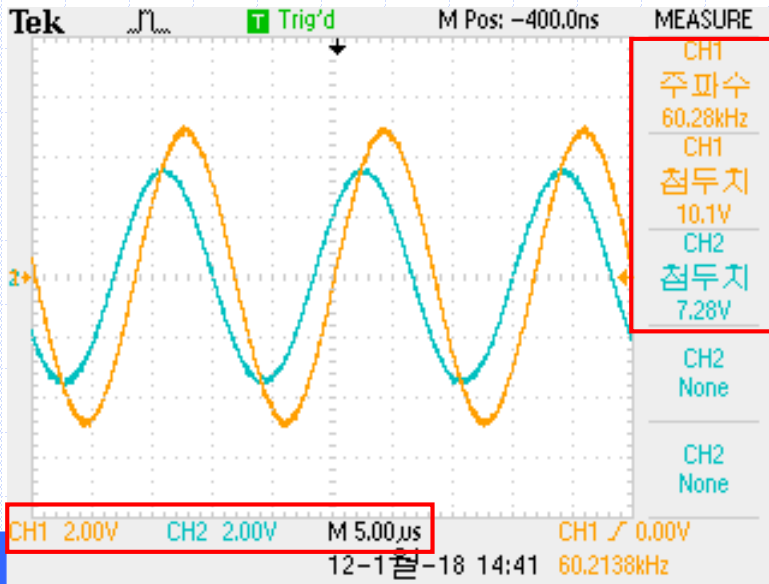
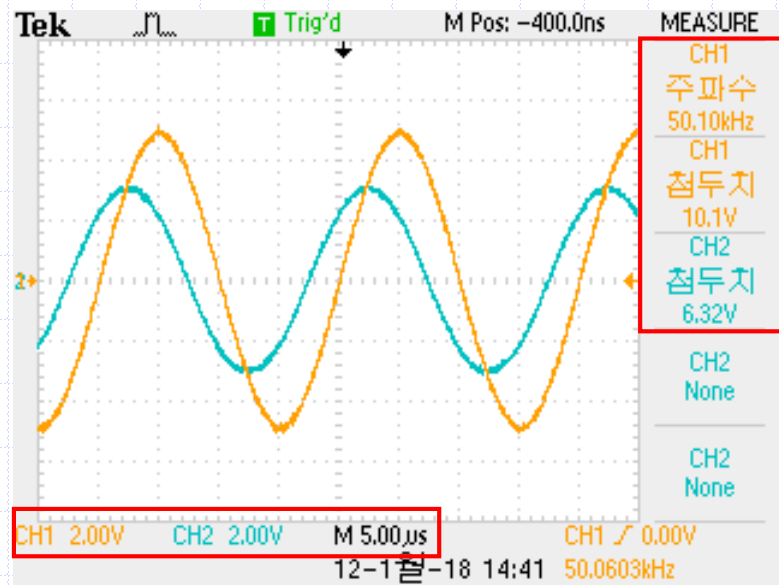
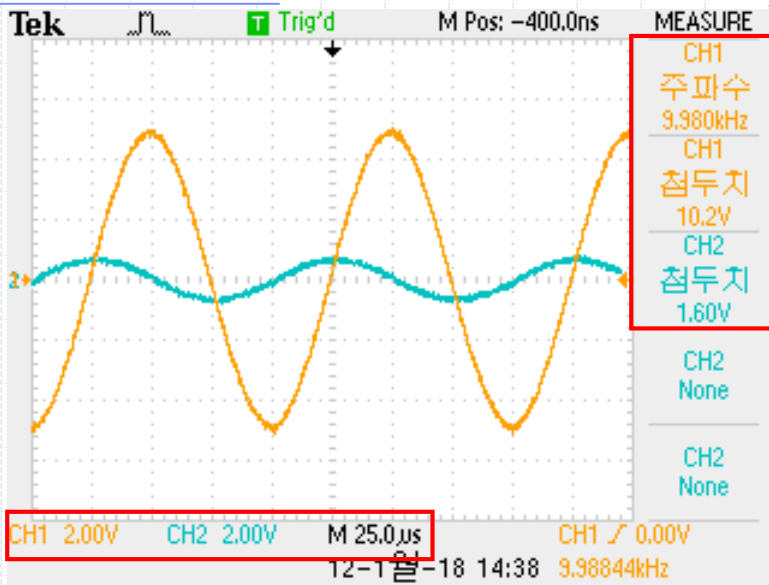

16-8. Band Pass Filter-BPF

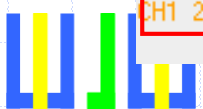
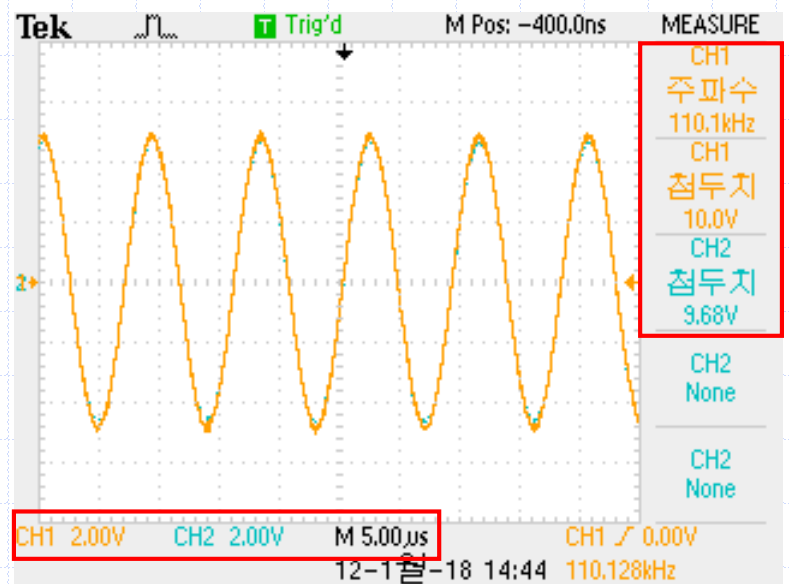
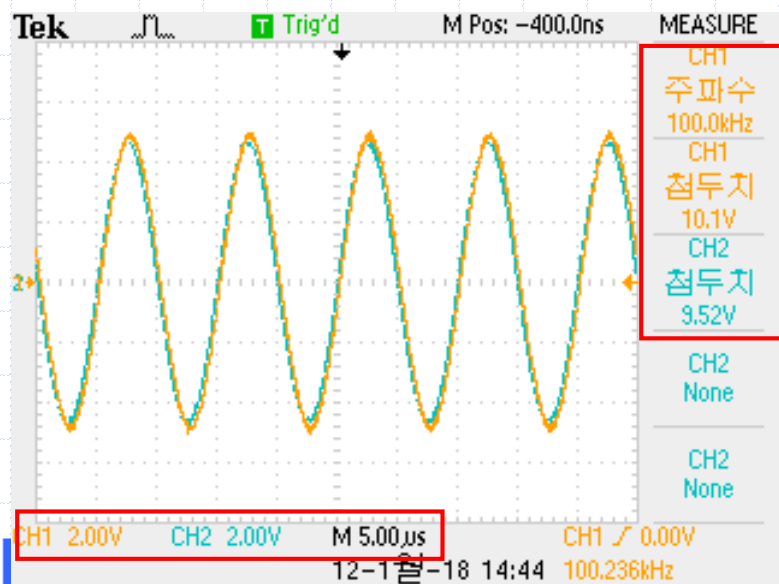
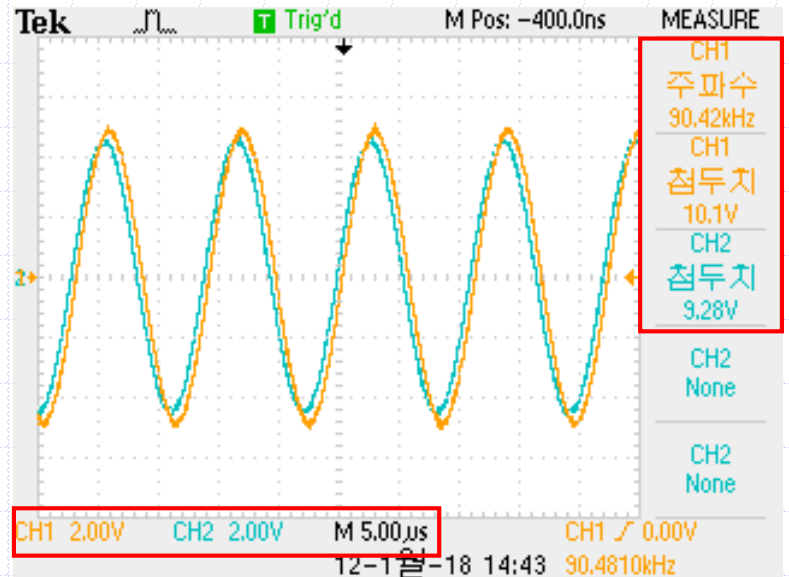
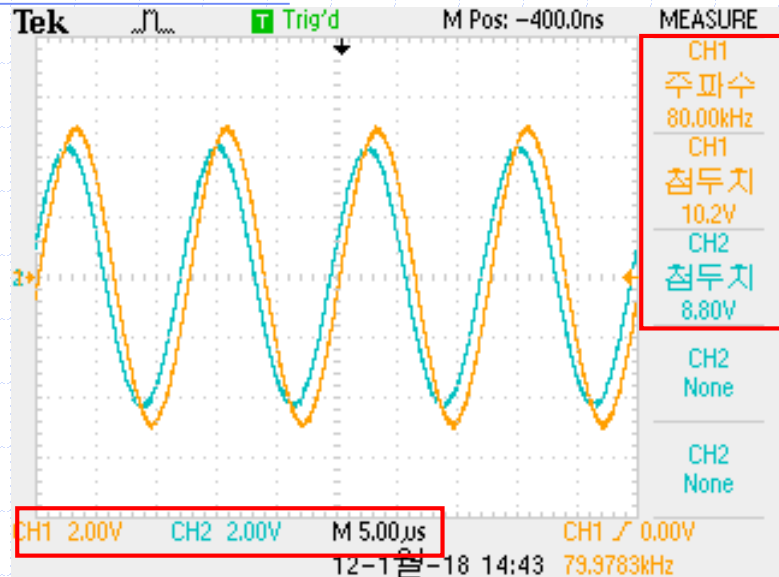

16-8. Band Pass Filter-BPF

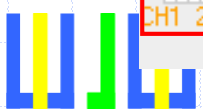
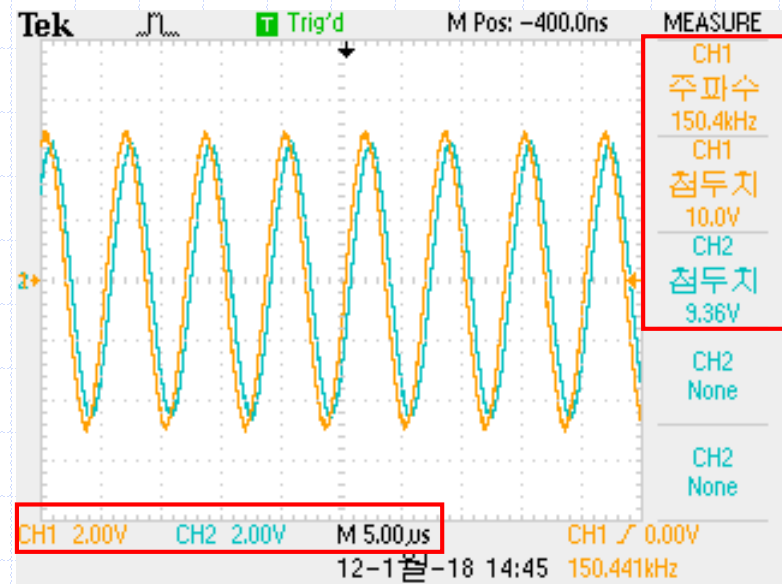
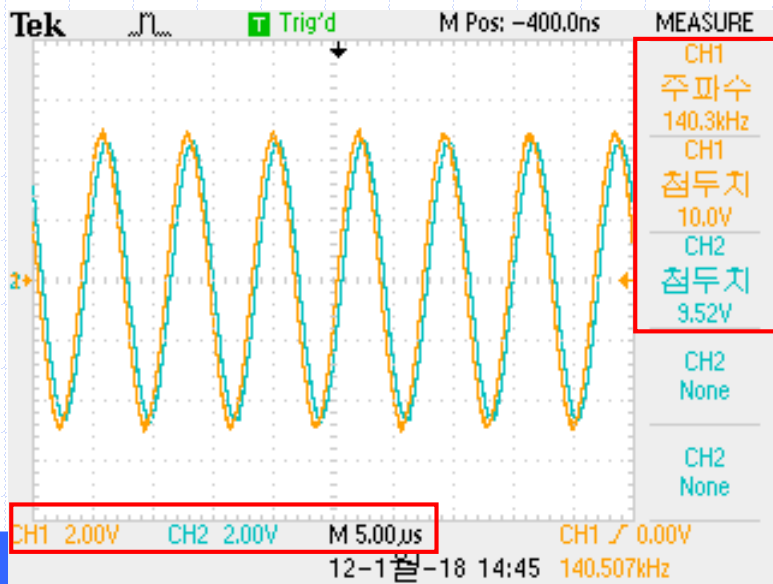
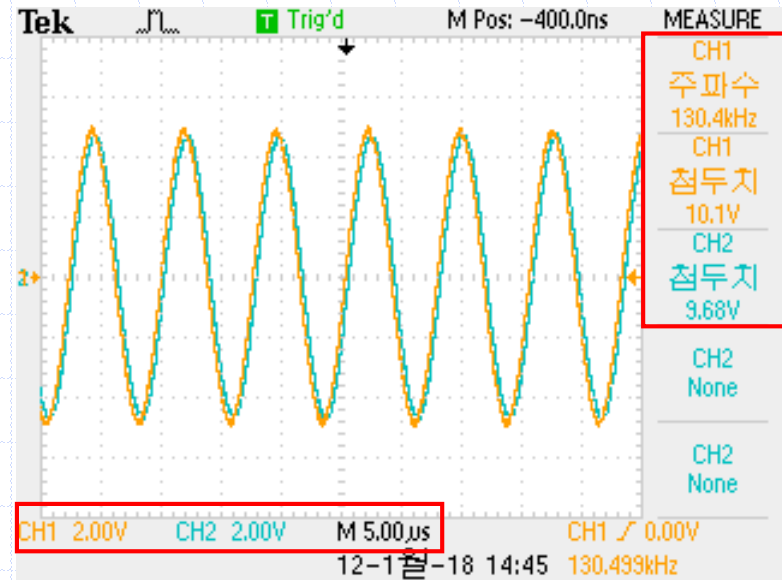
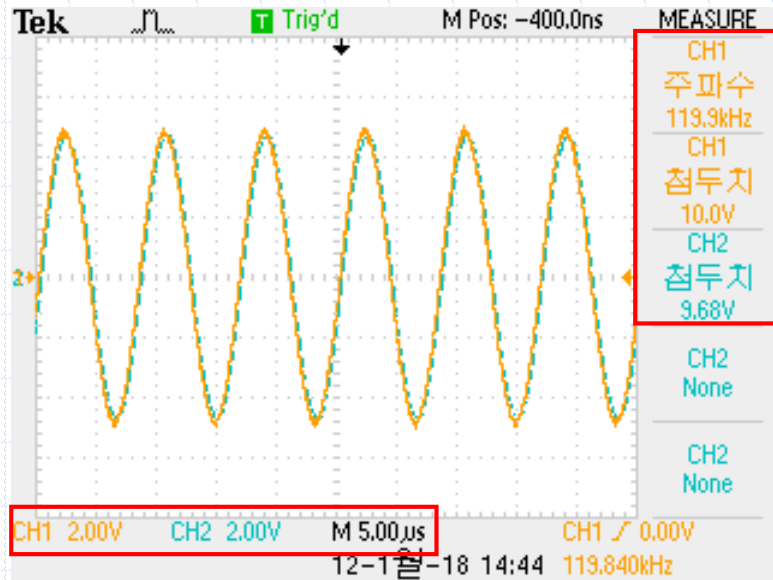

16-8. Band Pass Filter-BPF

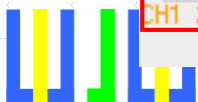
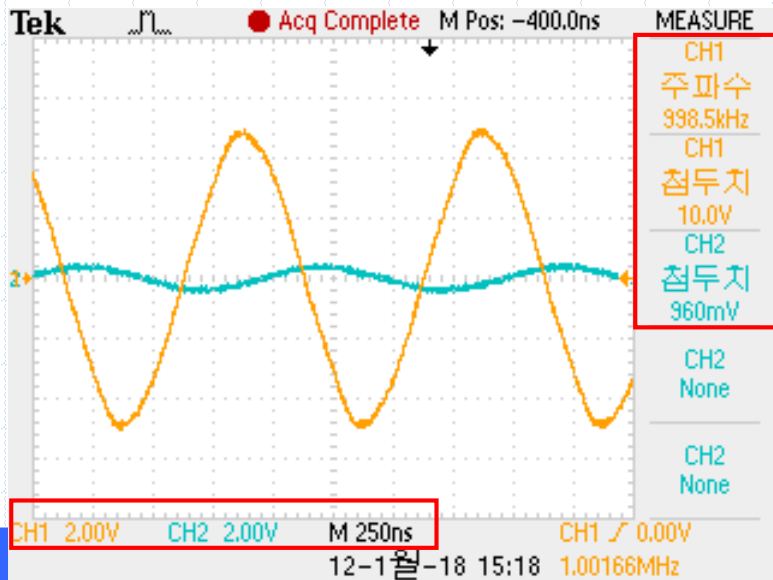
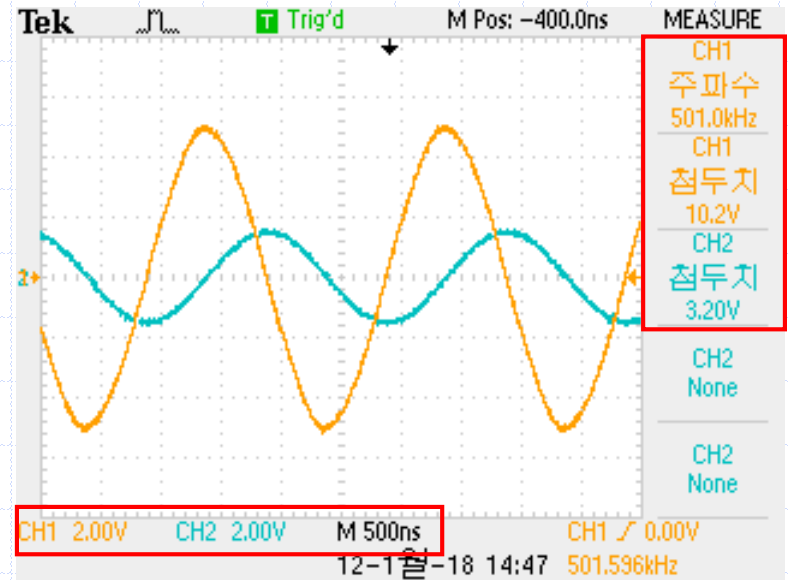
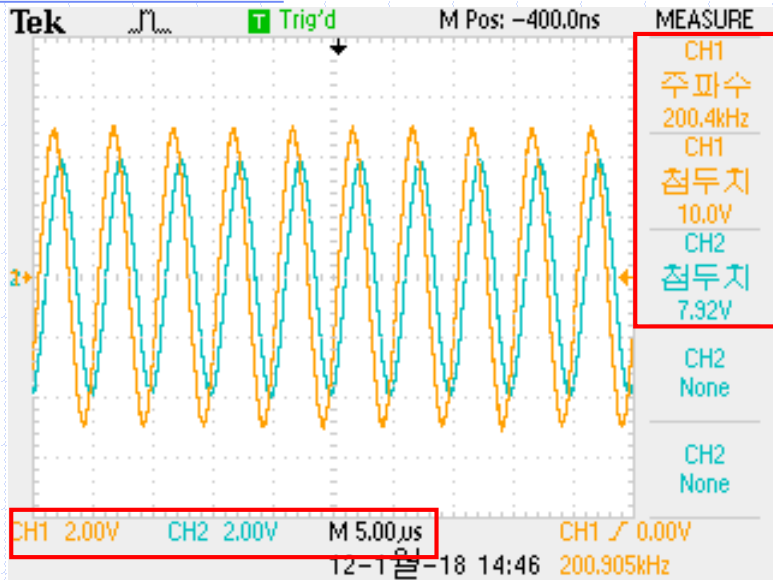

16-8. Band Pass Filter-BPF

주파수 (kHz)	Vin [Vpp]	계산값			측정값		
		Vout [Vpp]	이득	이득 (dB)	Vout [Vpp]	이득	이득 (dB)
5	10	0.69	0.069	-23.21	0.96	0.096	-20.355
10	10	1.38	0.138	-17.20	1.60	0.160	-15.918
50	10	6.62	0.662	-3.59	6.32	0.632	-3.986
60	10	7.70	0.770	-2.27	7.28	0.728	-2.757
70	10	8.60	0.860	-1.31	8.08	0.808	-1.852
80	10	9.28	0.928	-0.65	8.80	0.880	-1.110
90	10	9.73	0.973	-0.24	9.28	0.928	-0.649
100	10	9.96	0.996	-0.04	9.52	0.952	-0.427
110	10	9.99	0.999	0.00	9.68	0.968	-0.282
120	10	9.89	0.989	-0.10	9.68	0.968	-0.282
130	10	9.68	0.968	-0.28	9.68	0.968	-0.282
140	10	9.40	0.940	-0.54	9.52	0.952	-0.427
150	10	9.08	0.908	-0.83	9.36	0.936	-0.574
200	10	7.45	0.745	-2.55	7.92	0.792	-2.026
500	10	3.17	0.317	-9.99	3.20	0.320	-9.897
1,000	10	1.59	0.159	-15.97	0.96	0.096	-20.355

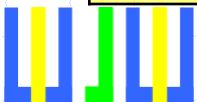

16-8. Band Pass Filter-BPF

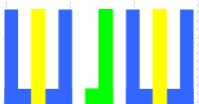
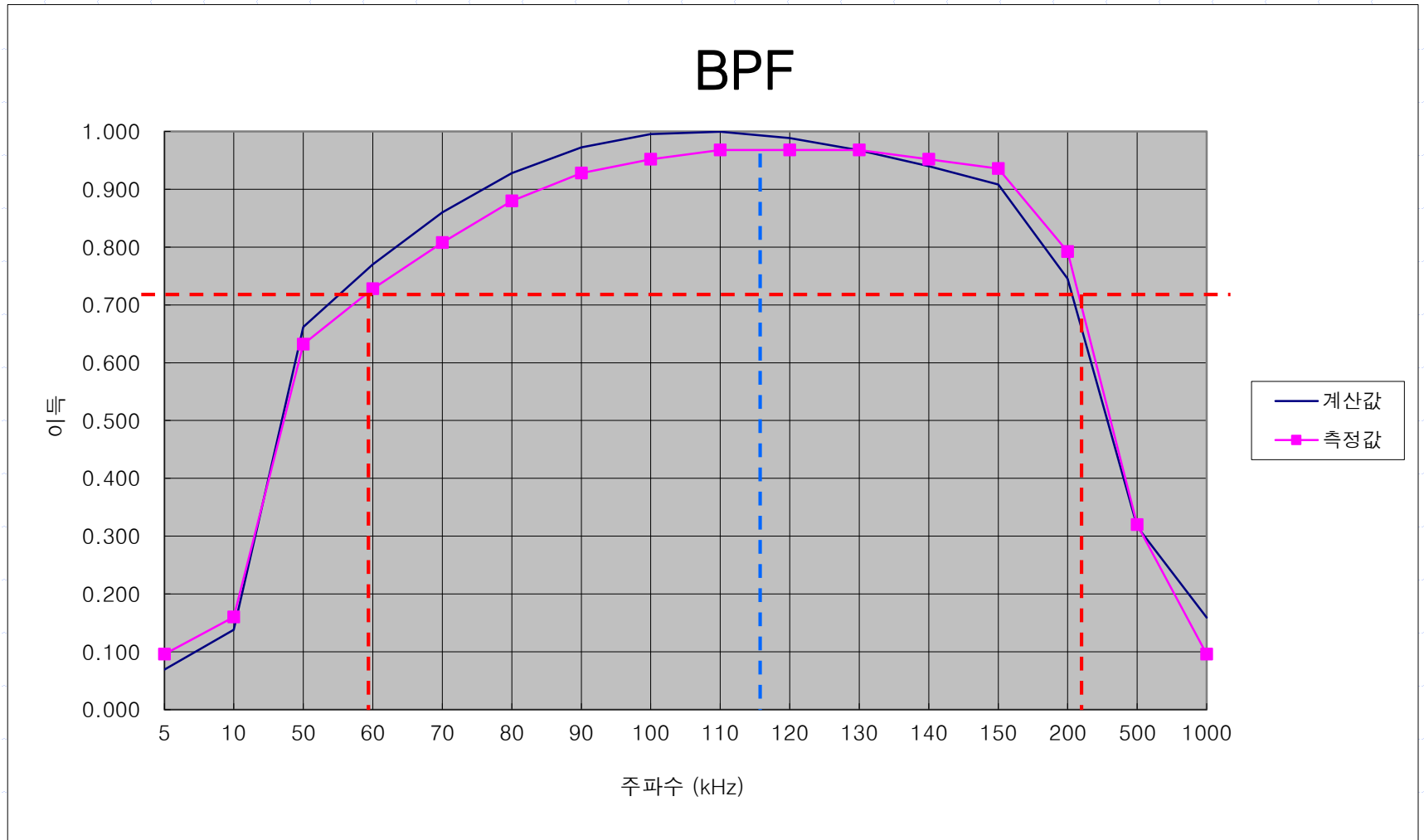

16-8. Band Pass Filter-BPF

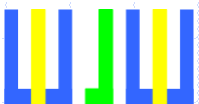
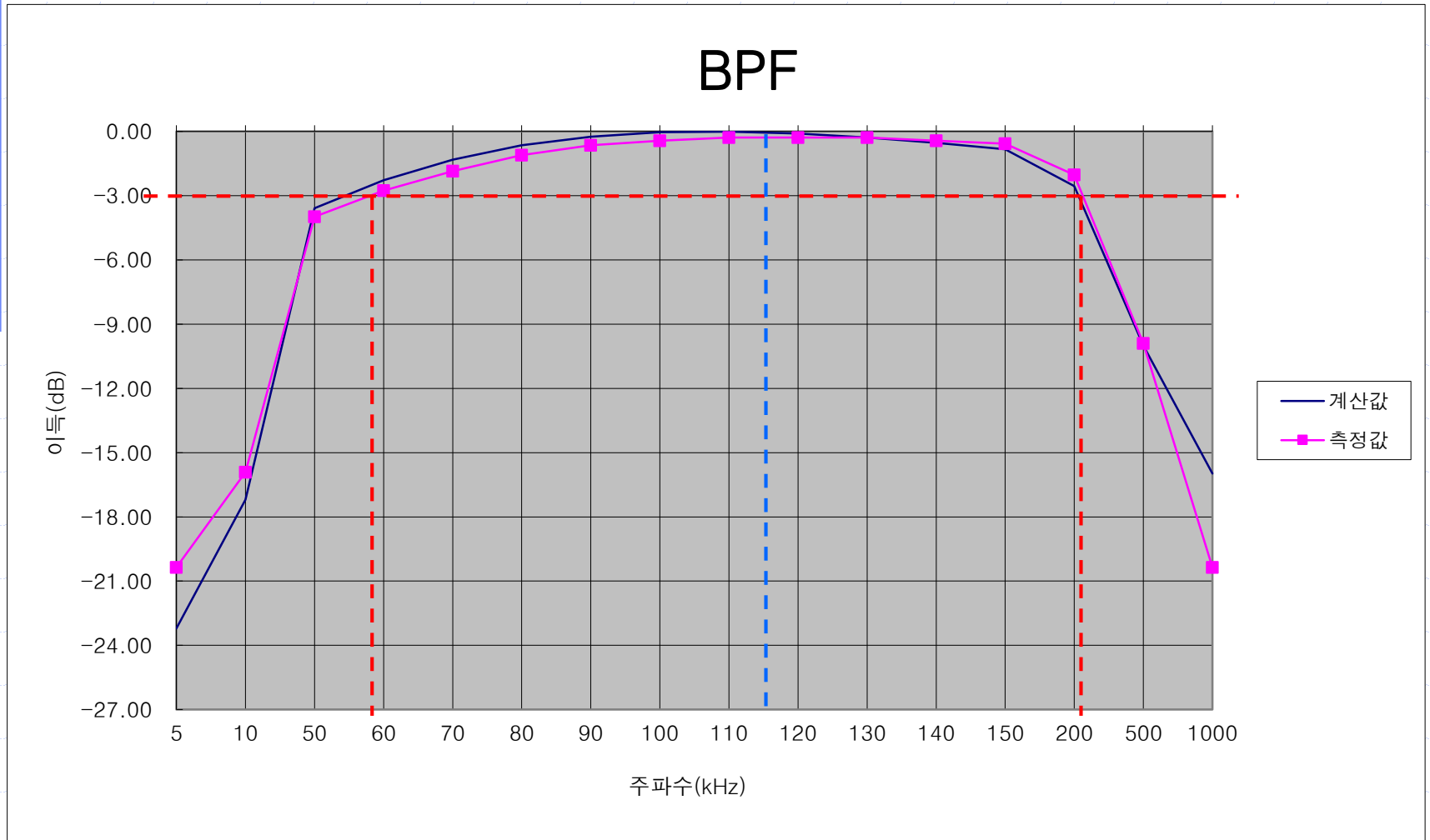

16-8. Band Pass Filter-BPF

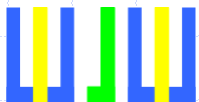
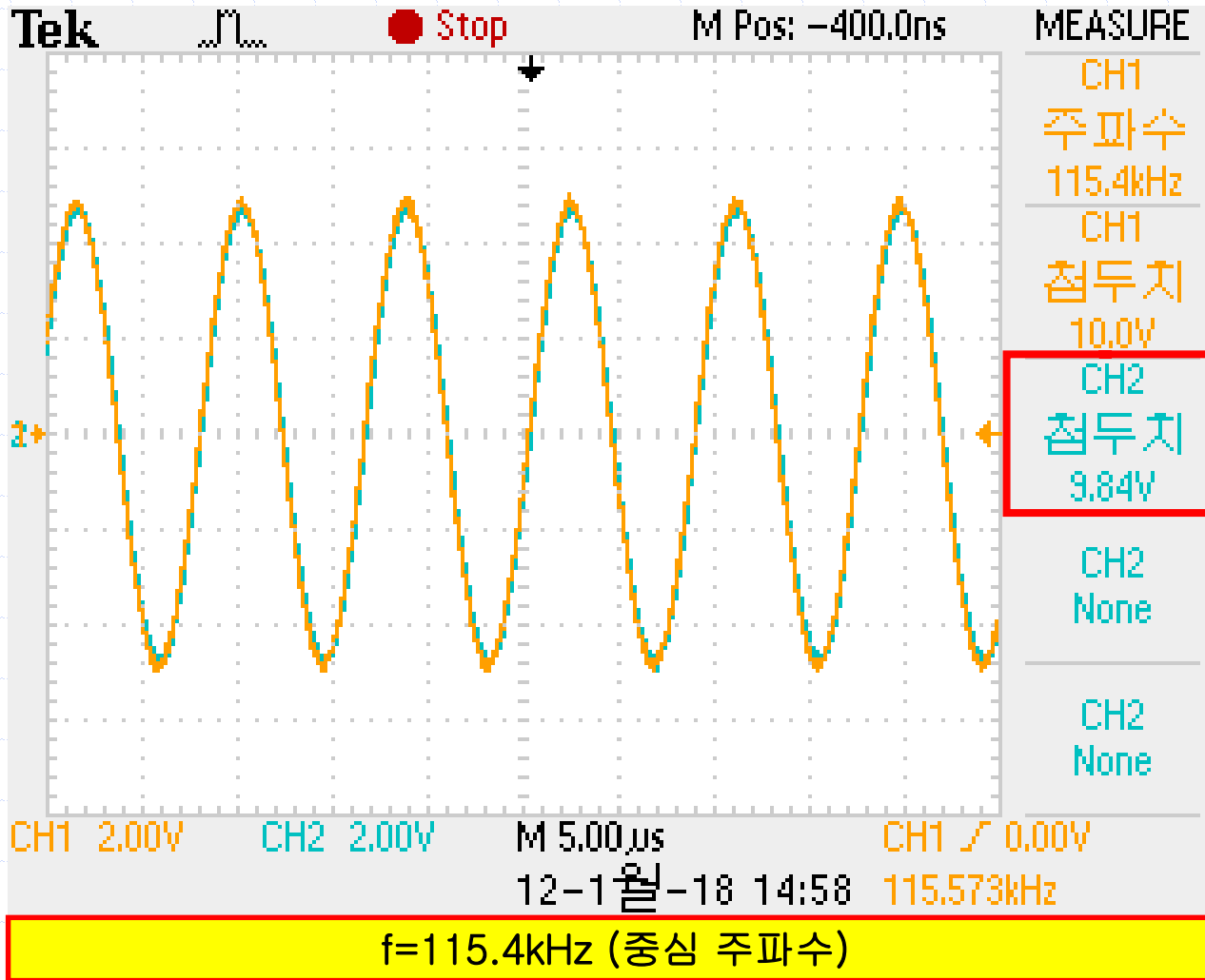

16-8. Band Pass Filter-BPF

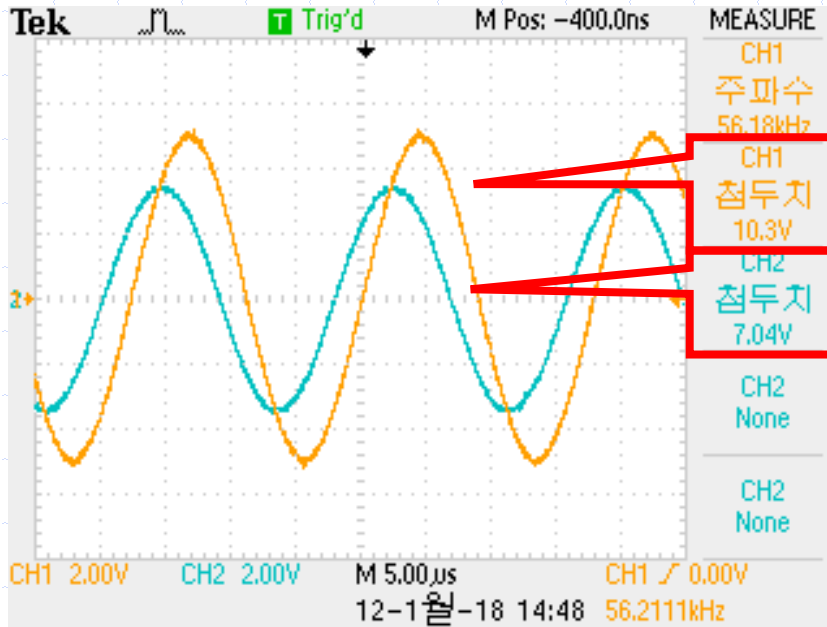

f=56.18kHz (하한 주파수)

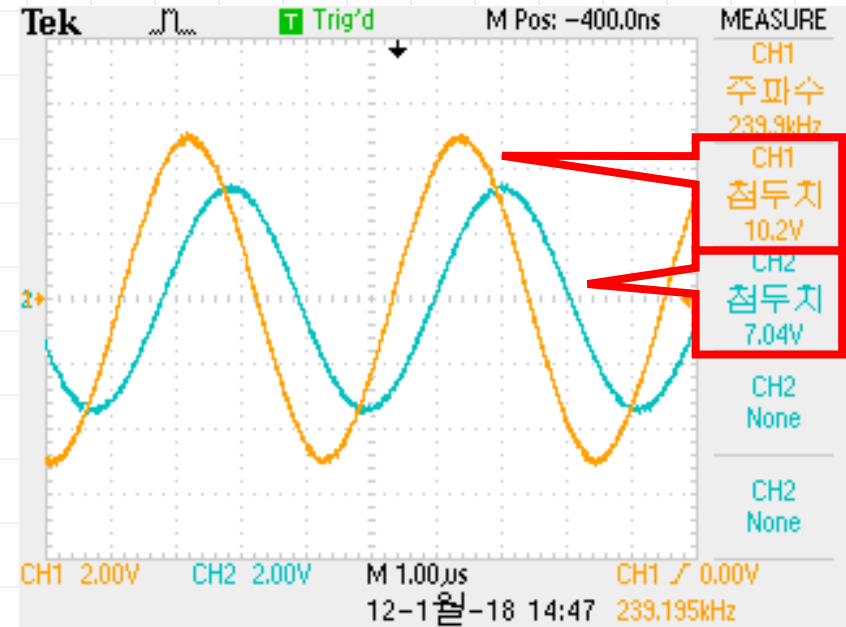

f=239.9kHz (상한 주파수)

$$10V_{pp} \times 0.707 = 7.07V_{pp}$$

