

# 회로 이론/실습

## 9. 인덕터

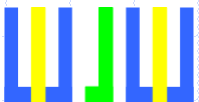

# 9. 인덕터

9-1. 목적 및 배경

9-2. 소요 부품 및 장비

9-3. 유용한 공식

9-4. 인덕터의 리액턴스

8-5. 주파수에 따른 인덕터의 특성

8-6. 인덕터의 전압, 전류 위상차

8-7. 인덕터의 AC, DC 특성

8-8. 위상차

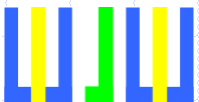

## 9-1. 목적 및 배경

- ✓ 인덕터의 용량을 읽는 법을 학습한다.
- ✓ 인덕터와 저항의 직렬회로를 해석한다.
- ✓ 주파수에 따라 인덕터의 리액턴스값의 변화를 실험한다.
- ✓ 인덕터에 의한 위상의 변화를 관측한다.

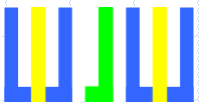

## 9-2. 소요 부품 및 장비

### ✓ 부품

- ✓ 저항 (1/4W) : 100 $\Omega$ , 1k $\Omega$
- ✓ 인덕터 : 1mH, 33mH

### ✓ 장비

- ✓ 브레드 보드
- ✓ 디지털 멀티미터 (Digital Multi-Meter)
- ✓ 직류전원장치 (DC Power Supply)
- ✓ 오실로스코프 (Oscilloscope)
- ✓ 신호발생기 (Function Generator)

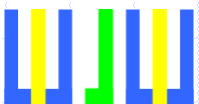

# 9-3. 유용한 공식

✓ 색깔로 용량 표시 (저항과 같음)

번호	0	1	2	3	4	5	6	7	8	9		
색깔	흑색	갈색	적색	등색	황색	녹색	청색	자색	회색	백색	금색	은색
color	Black	Brown	Red	Orange	Yellow	Green	Blue	Violet	Gray	White	Gold	Silver
승수	$\times 10^0$ = $\times 1$	$\times 10^1$	$\times 10^2$	$\times 10^3$	$\times 10^4$	$\times 10^5$	$\times 10^6$	$\times 10^7$	$\times 10^8$	$\times 10^9$	$\times 0.1$	$\times 0.01$
오차율 (급수)	$\pm 20\%$	$\pm 1\%$ (F)	$\pm 2\%$ (G)	$\pm 3\%$	$\pm 4\%$	-	-	-	-	$\pm 10\%$	$\pm 5\%$ (J)	$\pm 10\%$ (K)

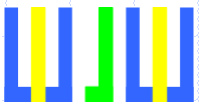

# 9-3. 유용한 공식

✓ 색깔로 용량을 표시

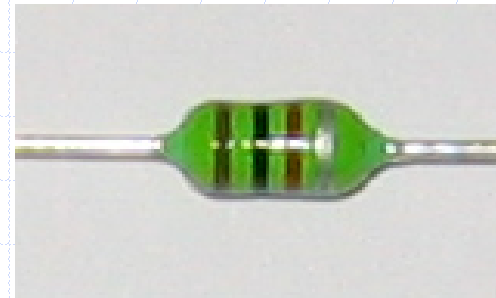
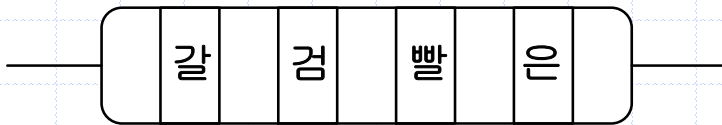
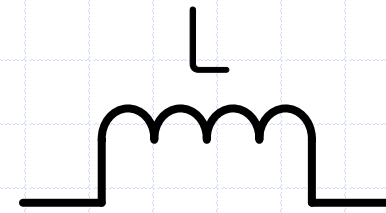
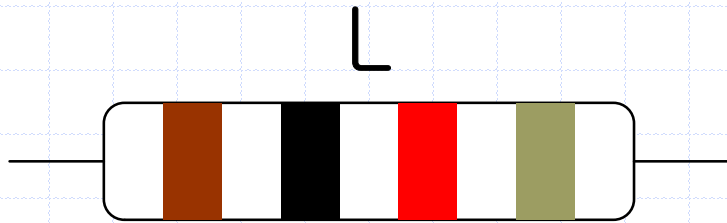

↓ ↓ ↓ ↓

1 0 X100 ±10% = 1,000μH 오차 ±10% 저항  
= 1mH 오차 ±10% 저항

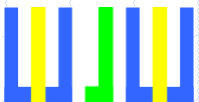

## 9-3. 유용한 공식

✓ 용량을 숫자로 표시

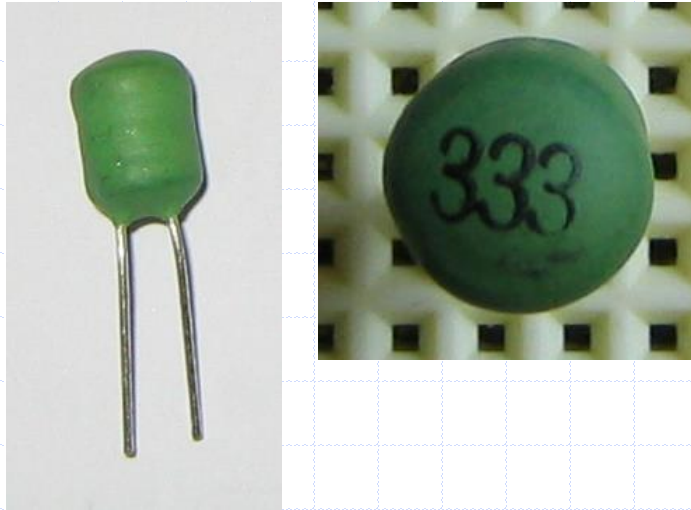

✓ 용량 : 33mH

$\frac{3}{\blacktriangledown}$	$\frac{3}{\blacktriangledown}$	$\frac{3}{\blacktriangledown}$	
3	3	X1000	uH

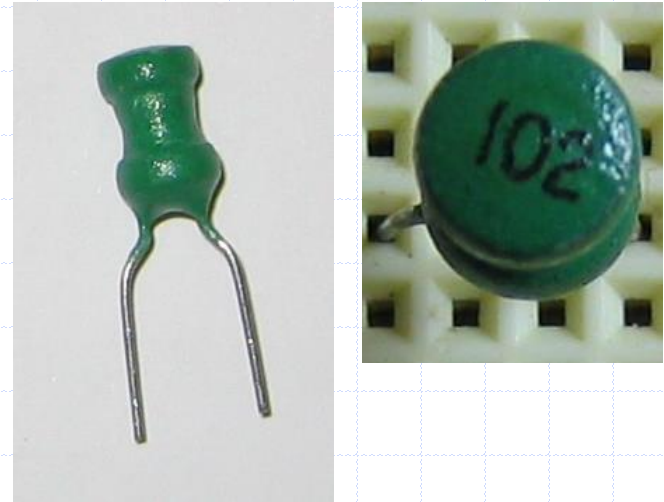

✓ 용량 : 1mH

$\frac{1}{\blacktriangledown}$	$\frac{0}{\blacktriangledown}$	$\frac{2}{\blacktriangledown}$	
1	0	X100	uH

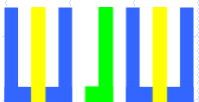

## 9-3. 유용한 공식

- ✓ 인덕터의 리액턴스

$$X_L = \omega L = 2\pi fL$$

- ✓ 각주파수 ( $\omega$ )

$$\omega = 2\pi f$$

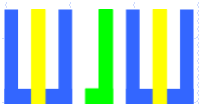



# 9-4. 인덕터의 리액턴스

- 다음과 같이 회로를 연결하고, 신호발생기를 조절하여 주파수 1kHz, 1Vrms 의 정현파가 나오도록 한다.

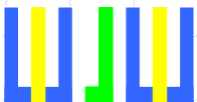
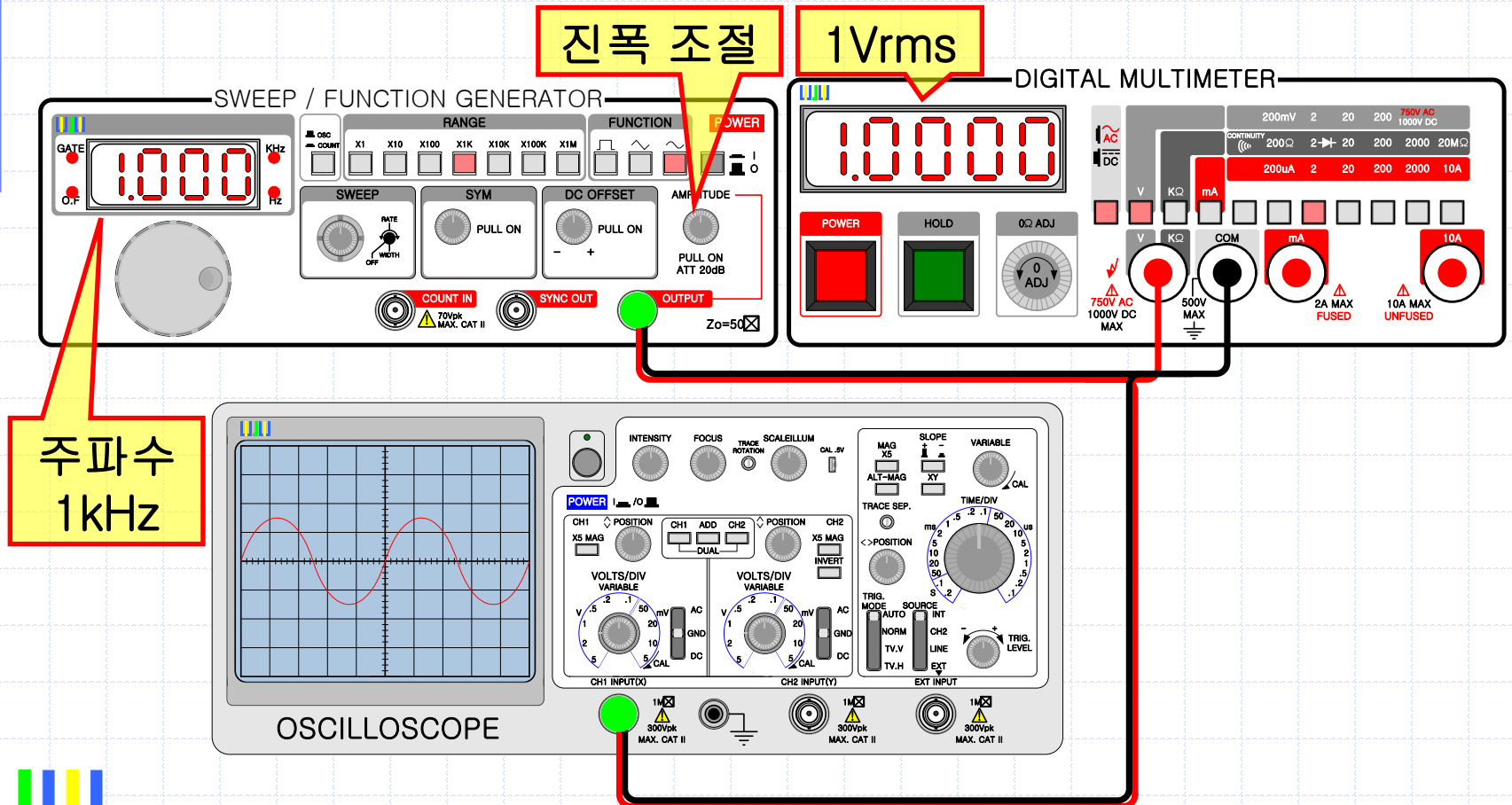

# 9-4. 인덕터의 리액턴스

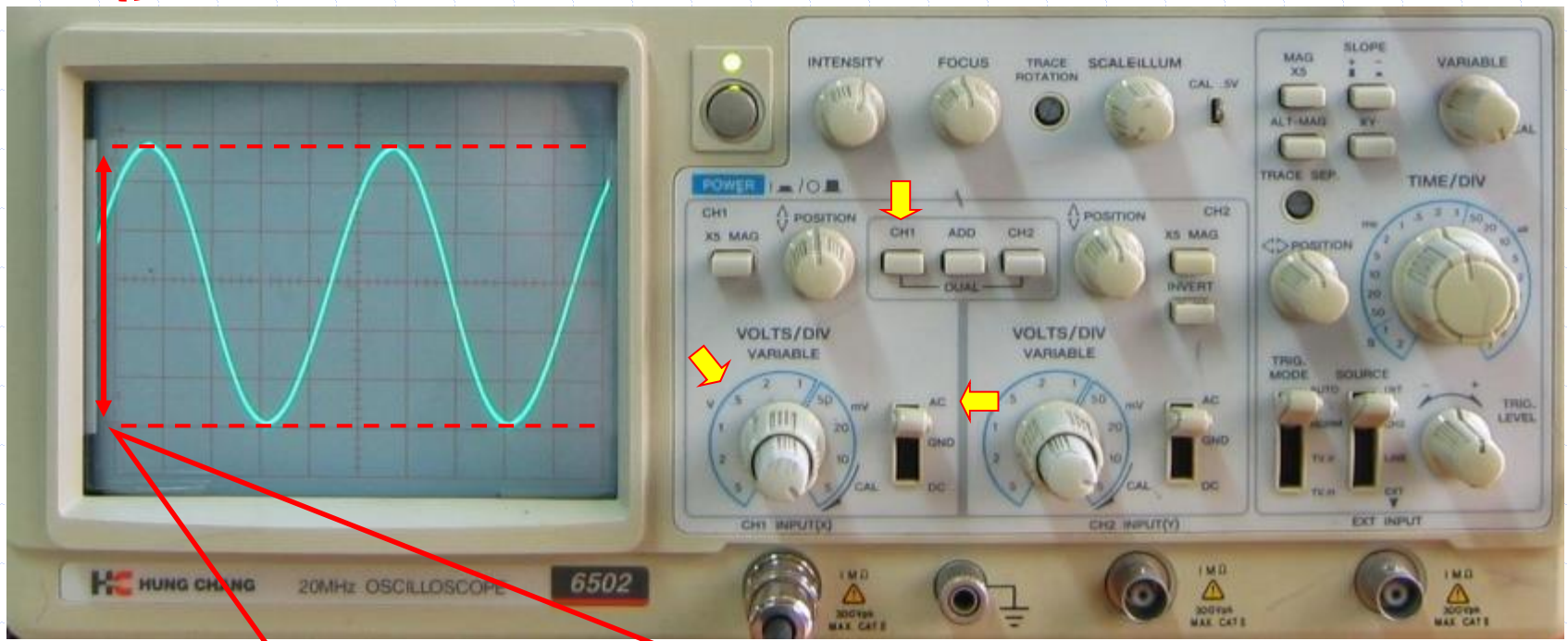
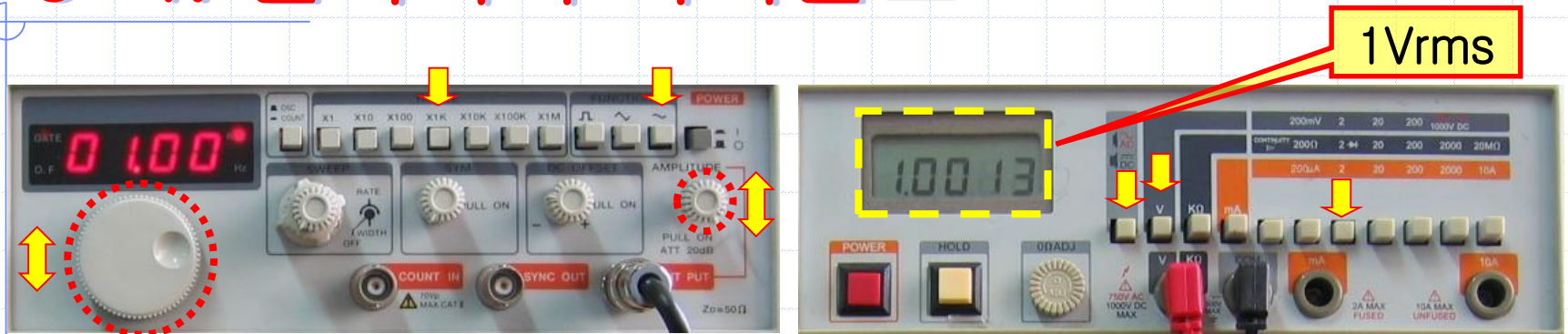

$5.6\text{칸} \times 0.5\text{V/DIV} = 2.8\text{Vpp}$ ,  $2.8\text{Vpp} / 2 = 1.4\text{Vp}$ ,  $1.4\text{Vp} \times 0.707 = 1\text{Vrms}$

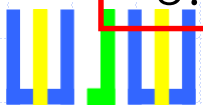

## 9-4. 인덕터의 리액턴스

- 다음과 같이 회로를 연결하고, 저항과 인덕터 양단의 전압을 디지털 멀티미터 (DMM) 을 사용하여 측정하라.

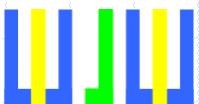
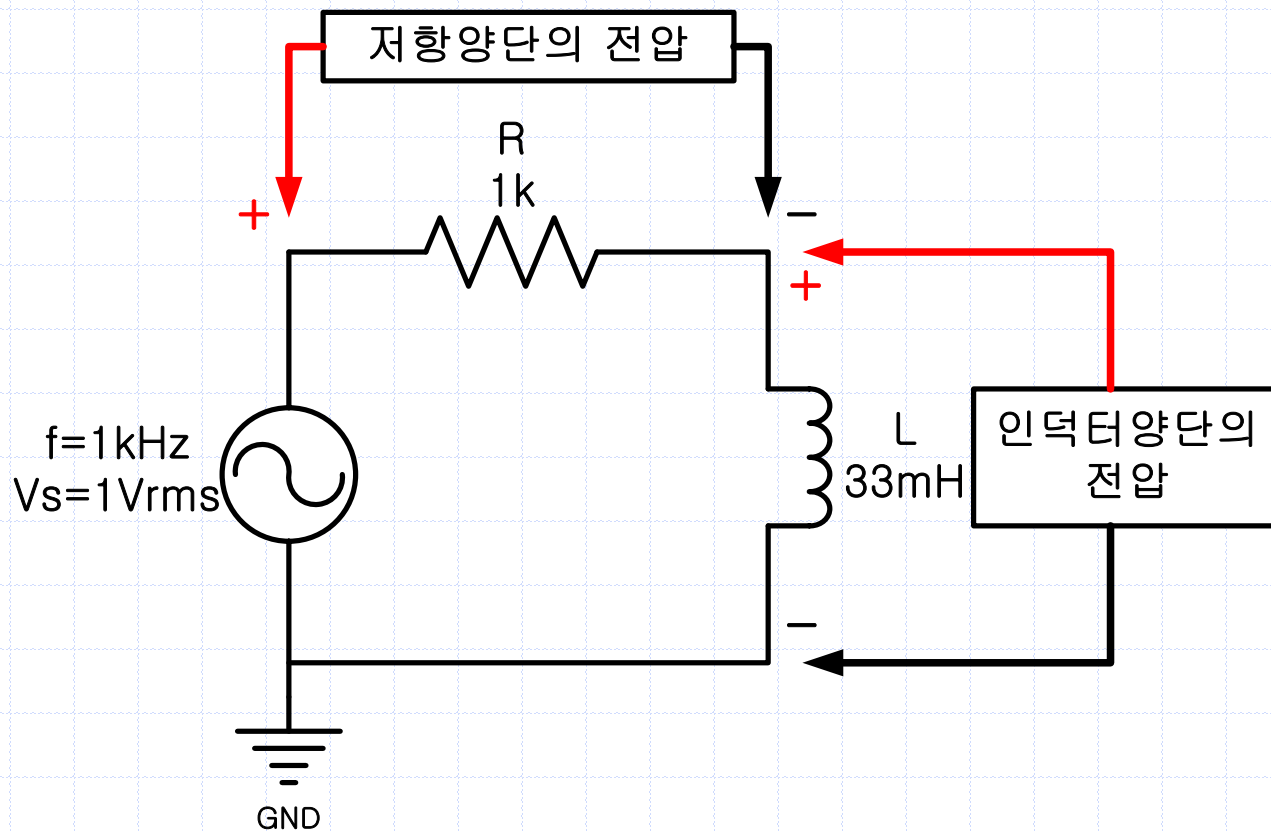

# 9-4. 인덕터의 리액턴스

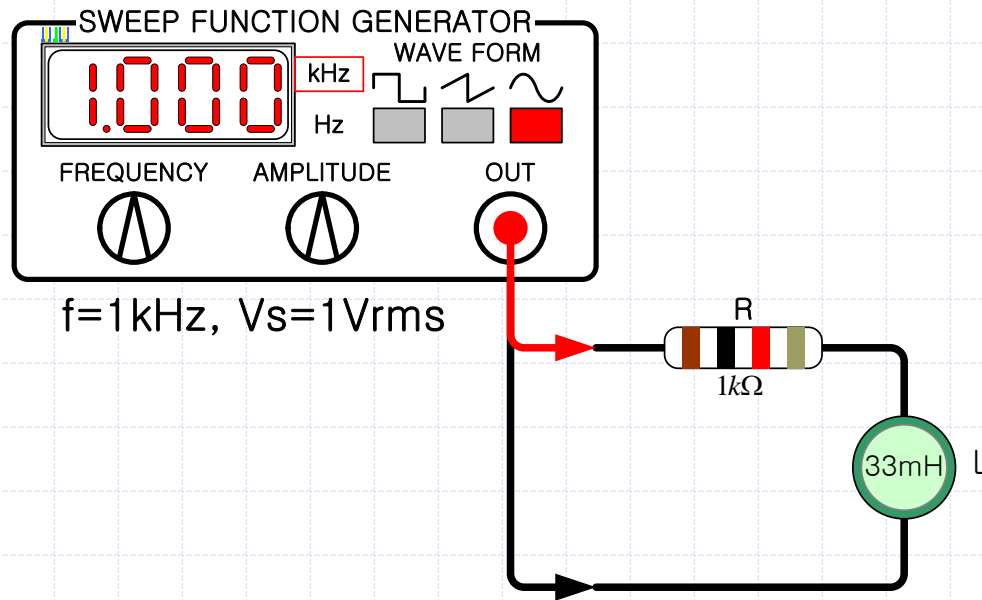

신호발생기  
Function Generator

정현파  
1kHz  
1Vrms

GND

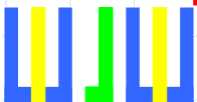
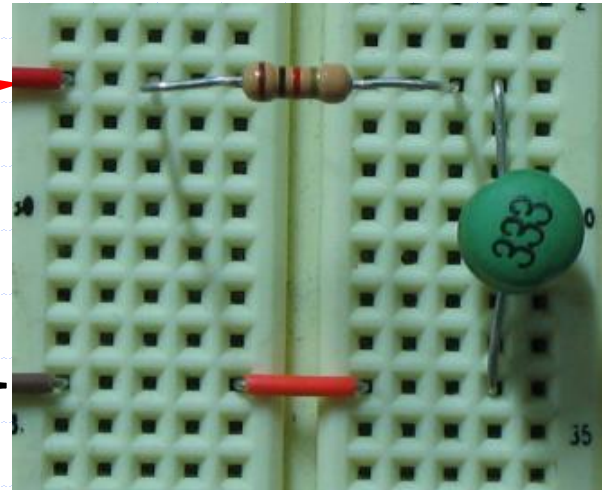

# 9-4. 인덕터의 리액턴스

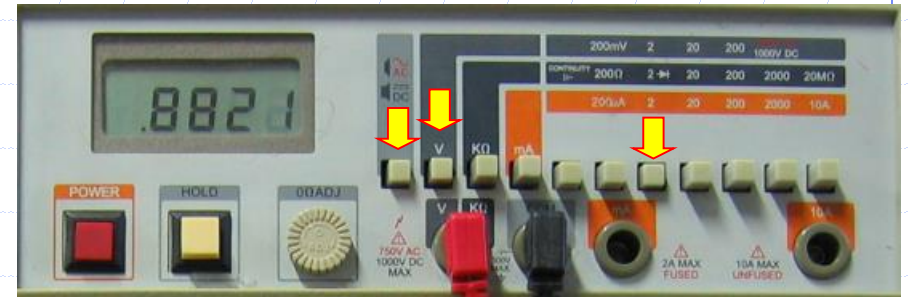
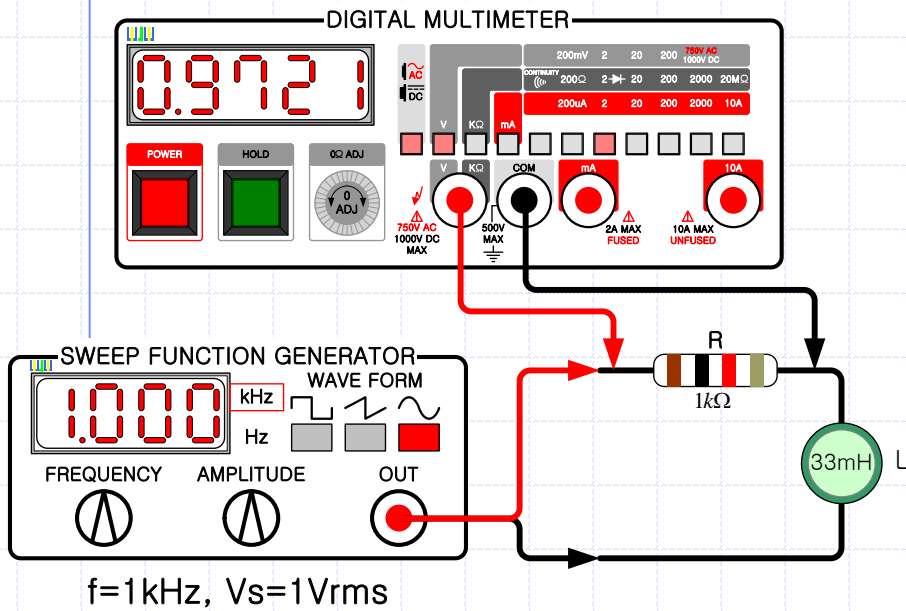

신호발생기  
Function Generator

정현파  
1kHz  
1Vrms

GND

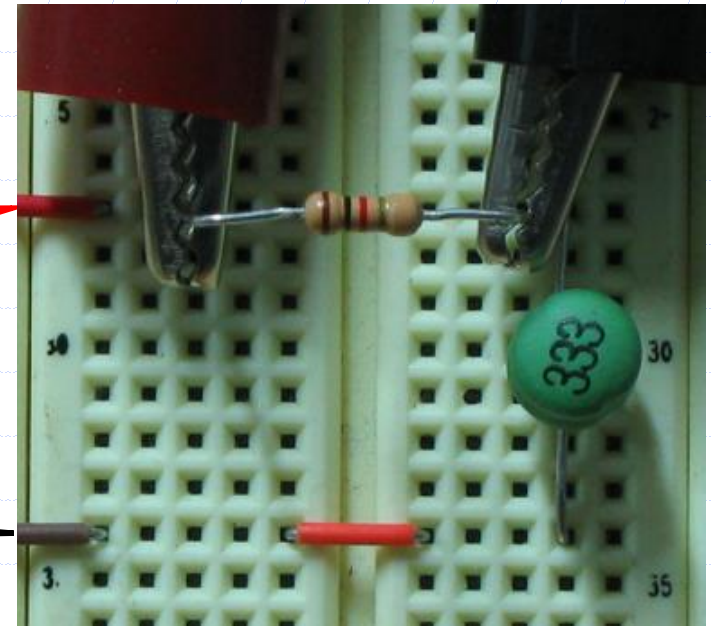

# 9-4. 인덕터의 리액턴스

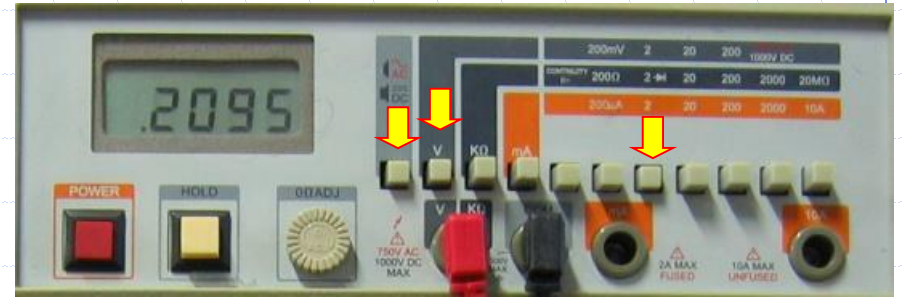
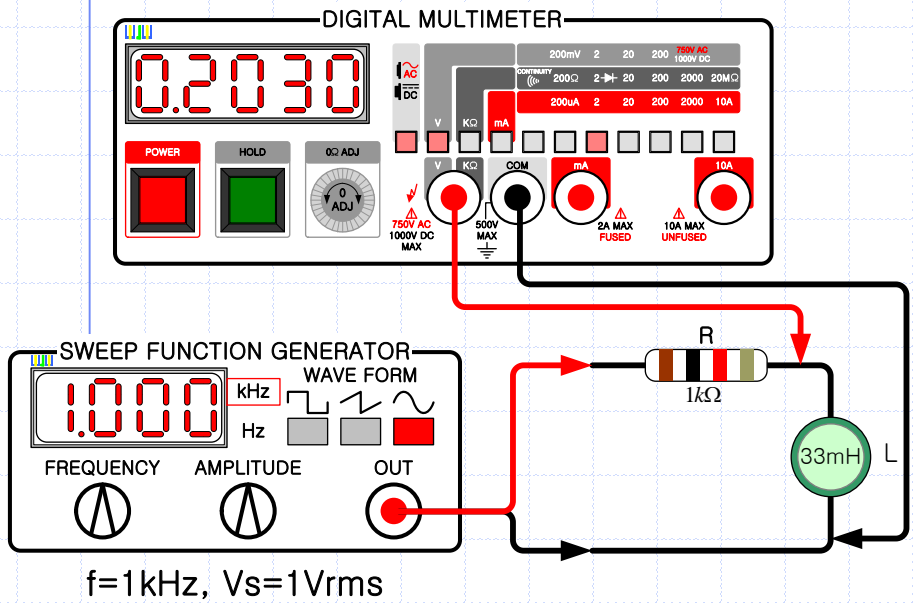

신호발생기  
Function Generator

정현파  
1kHz  
1Vrms

GND

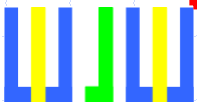
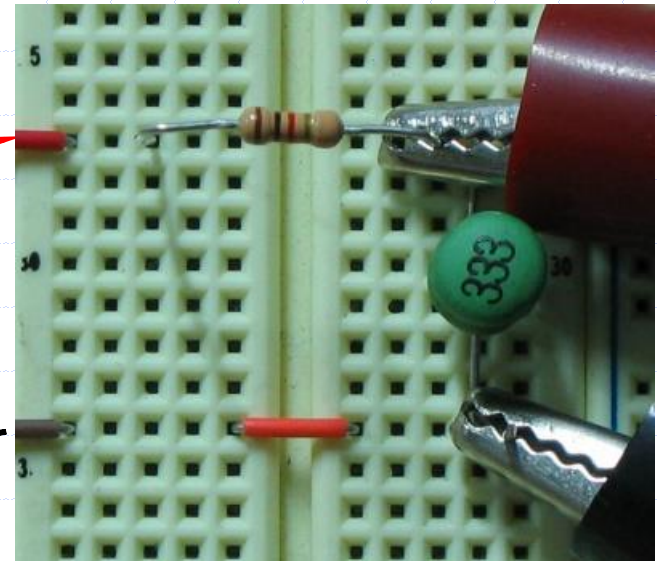

# 9-4. 인덕터의 리액턴스

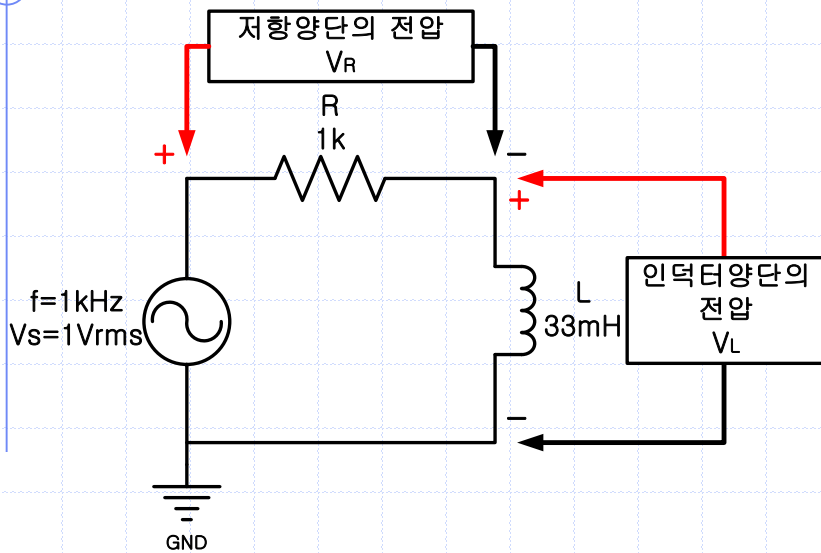

$$R = 1,000\Omega$$

$$\begin{aligned} X_L &= \omega L = 2\pi fL \\ &= 2\pi \times 1,000\text{Hz} \times 33 \times 10^{-3}\text{H} \\ &= 207.345\Omega \end{aligned}$$

$$\begin{aligned} Z &= R + jX_L = 1,000 + j207.345[\Omega] \\ &= 1021.27 \angle 11.714^\circ[\Omega] \end{aligned}$$

$$\begin{aligned} V_R &= \frac{R}{R + jX_L} \times v_s = \frac{1,000[\Omega]}{1,000 + j207.345[\Omega]} \times 1V_{rms} = \frac{1,000 \angle 0^\circ[\Omega]}{1021.27 \angle 11.714^\circ[\Omega]} \times 1V_{rms} \\ &= 0.9792 \angle 11.714^\circ V_{rms} \end{aligned}$$

$$\begin{aligned} V_L &= \frac{jX_L}{R + jX_L} \times v_s = \frac{j207.345[\Omega]}{1,000 + j207.345[\Omega]} \times 1V_{rms} = \frac{207.345 \angle 90^\circ[\Omega]}{1021.27 \angle 11.714^\circ[\Omega]} \times 1V_{rms} \\ &= 0.203 \angle -78.26^\circ V_{rms} \end{aligned}$$

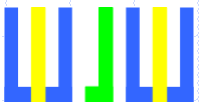

## 9-4. 인덕터의 리액턴스

$$V_R(\text{이론}) = 0.9721V$$

$$V_R(\text{실험}) = 0.8821V$$

$$V_L(\text{이론}) = 0.203V$$

$$V_L(\text{실험}) = 0.2095V$$

$$I_T(\text{이론}) = \frac{V_R}{R} = \frac{0.9721V}{1k\Omega} = 0.9721mA$$

$$I_T(\text{실험}) = \frac{V_R}{R} = \frac{0.8821V}{1k\Omega} = 0.8821mA$$

$$X_L(\text{이론}) = \frac{V_L}{I_T} = \frac{0.203V}{0.9721mA} = 208.83\Omega$$

$$X_L(\text{실험}) = \frac{V_L}{I_T} = \frac{0.2095V}{0.8821mA} = 237.5\Omega$$

$$\begin{aligned} L(\text{이론}) &= \frac{X_L}{2\pi f} \\ &= \frac{208.83\Omega}{2\pi \times 1,000Hz} \\ &= 0.03324H = 33.24mH \end{aligned}$$

$$\begin{aligned} L(\text{실험}) &= \frac{X_L}{2\pi f} \\ &= \frac{237.5\Omega}{2\pi \times 1,000Hz} \\ &= 0.0378H = 37.8mH \end{aligned}$$

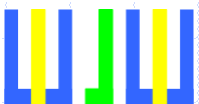



# 9-5A. 주파수에 따른 인덕터의 특성



5칸 X 2V/DIV = 10Vpp

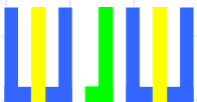
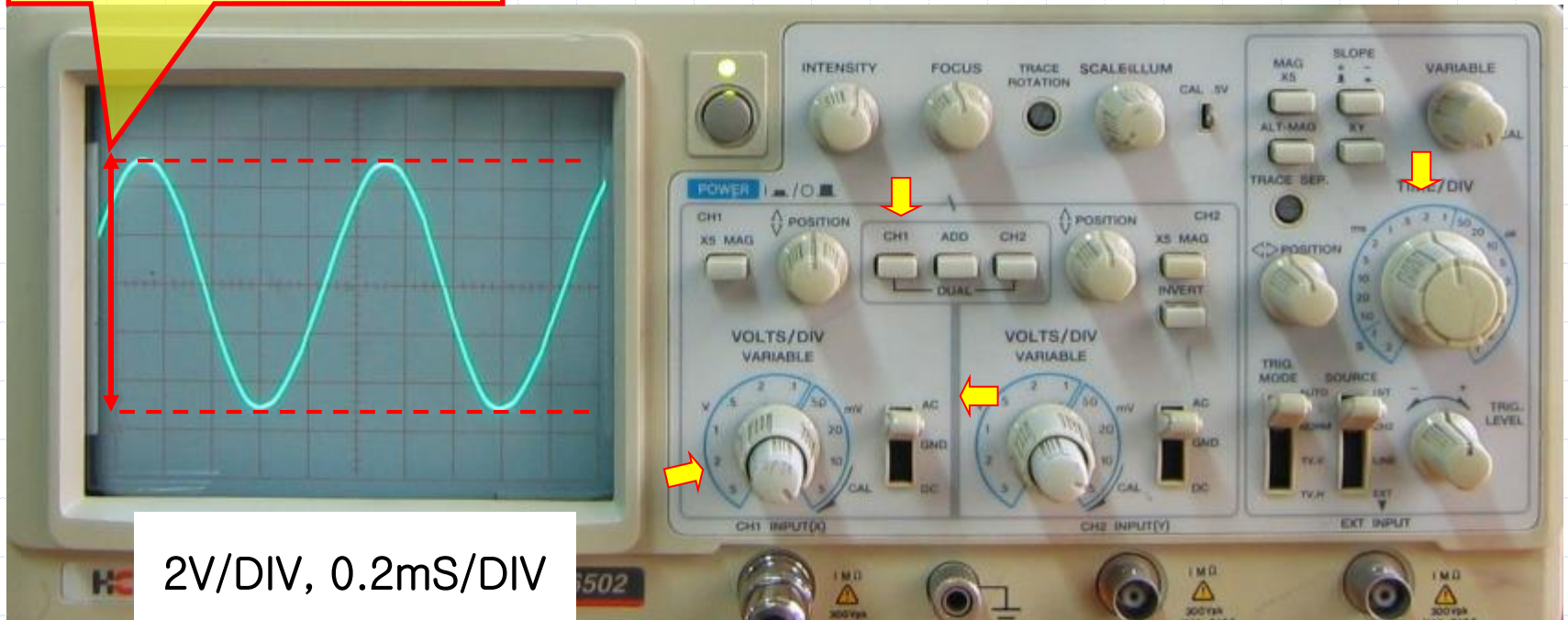

## 9-5A. 주파수에 따른 인덕터의 특성

- 다음과 같이 회로를 연결하고, 인덕터 양단의 전압을 오실로스코프를 사용하여 측정하라.

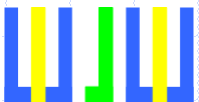
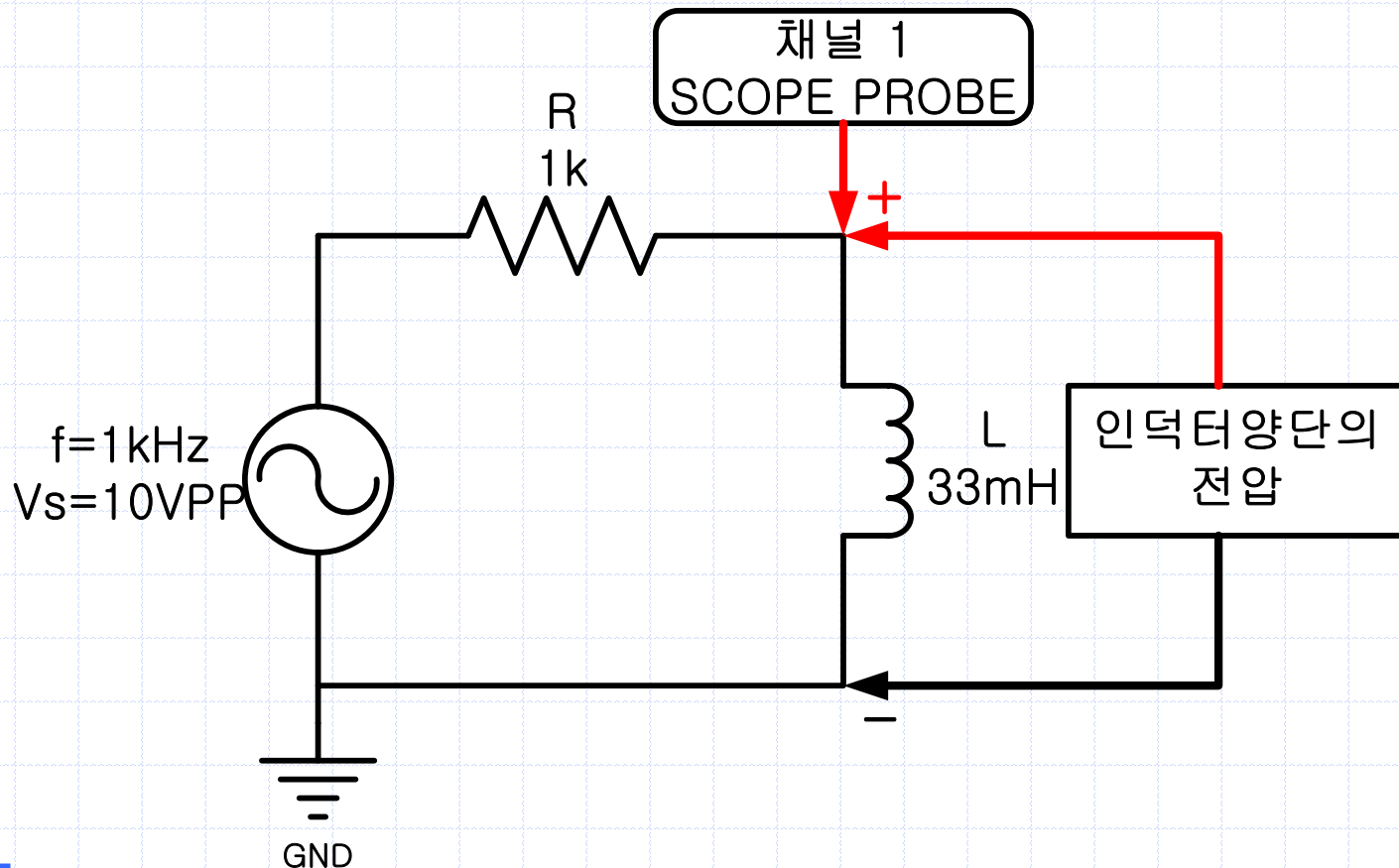

# 9-5A. 주파수에 따른 인덕터의 특성

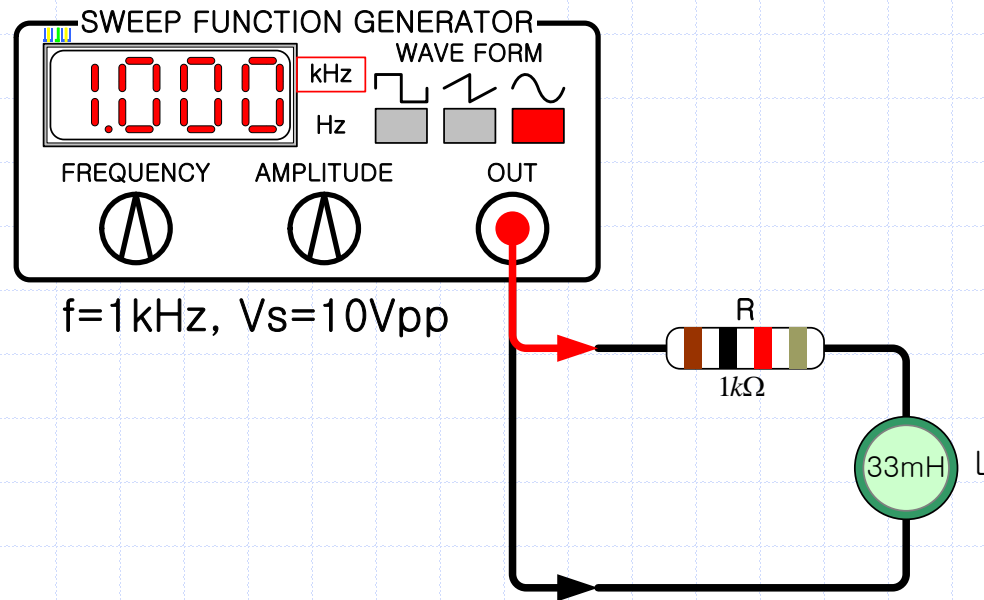

신호발생기  
Function Generator

정현파  
1 kHz  
10 Vpp

GND

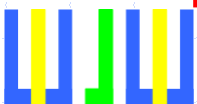
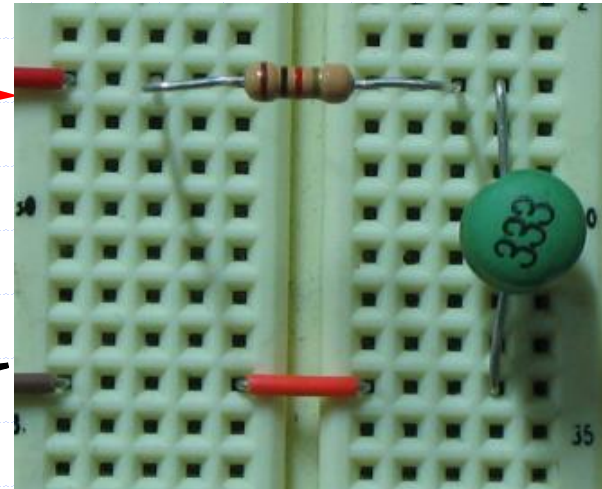

# 9-5A. 주파수에 따른 인덕터의 특성

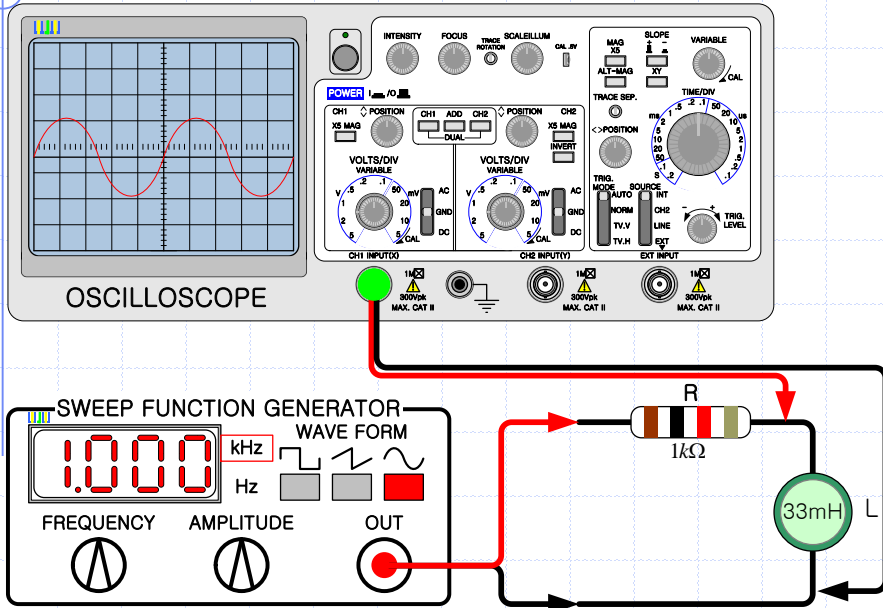

$f=1\text{kHz}, V_s=10\text{Vpp}$

신호발생기  
 Function Generator

정현파  
 1kHz  
 10Vpp

GND

$4.4\text{칸} \times 0.5\text{V/DIV} = 2.2\text{Vpp}$

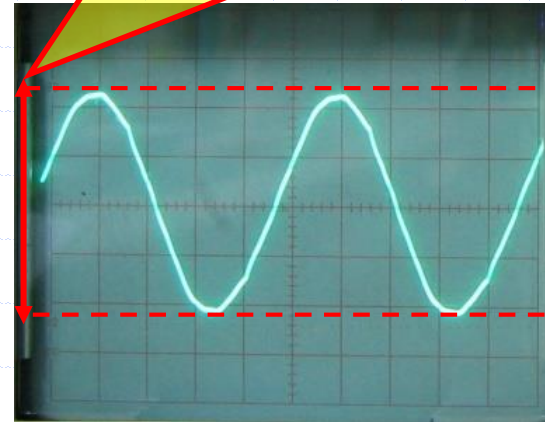

0.5V/DIV, 0.2mS/DIV

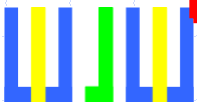
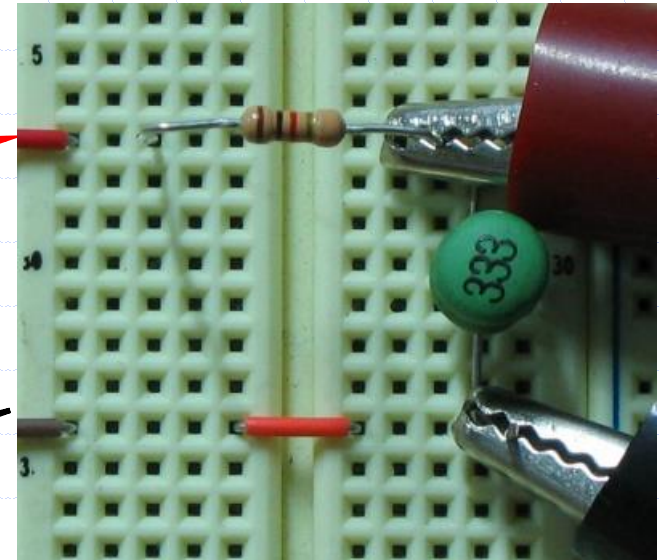

# 9-5A. 주파수에 따른 인덕터의 특성

- ✓ 주파수를 10kHz로 변경하고, 측정을 반복한다.

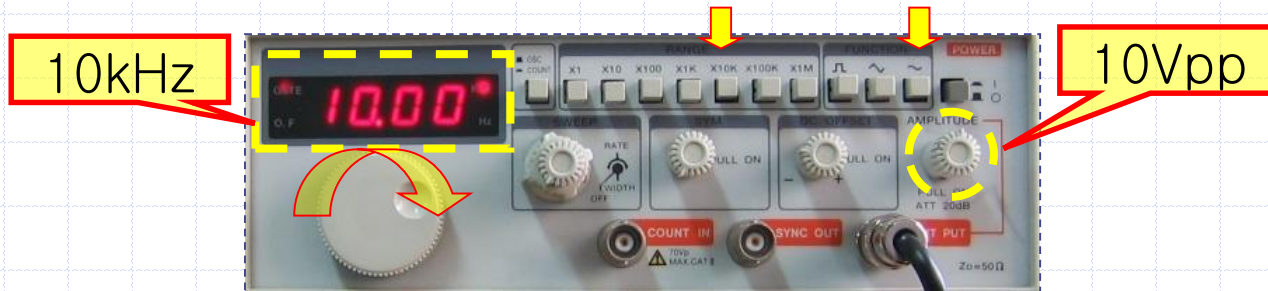

$$V_L : 4.5\text{칸} \times 2\text{V/DIV} = 9\text{Vpp}$$

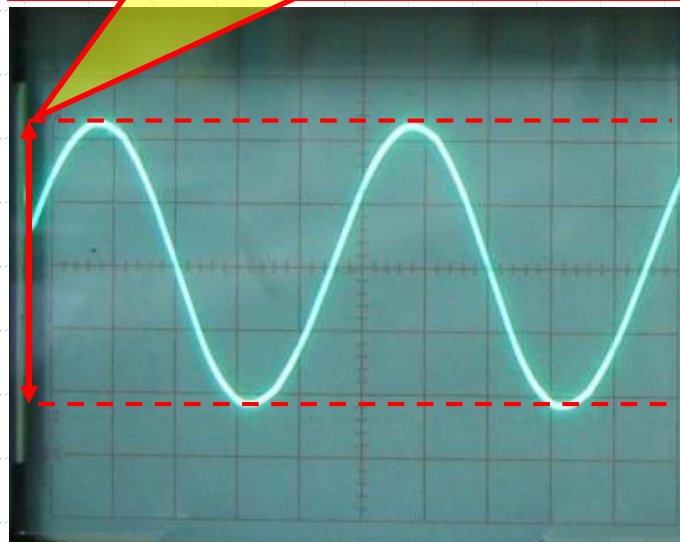

2V/DIV, 20uS/DIV

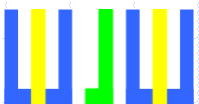

# 9-5A. 주파수에 따른 인덕터의 특성

- ✓ 주파수를 20kHz로 변경하고, 측정을 반복한다.

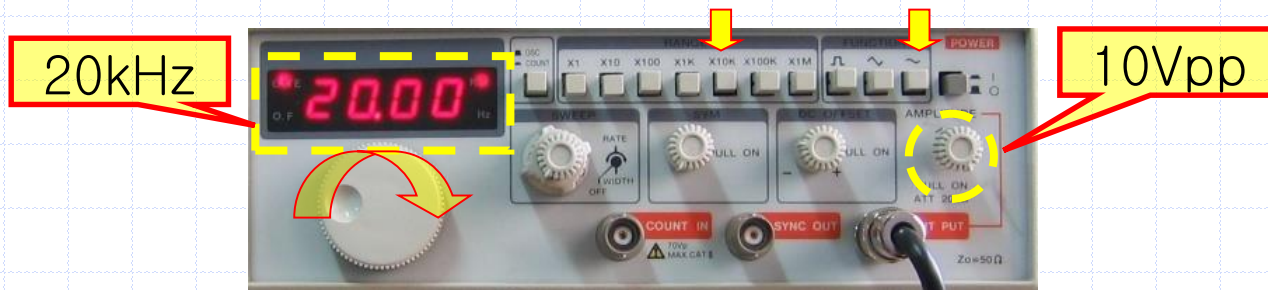

$$V_L : 4.9\text{칸} \times 2\text{V/DIV} = 9.8\text{Vpp}$$

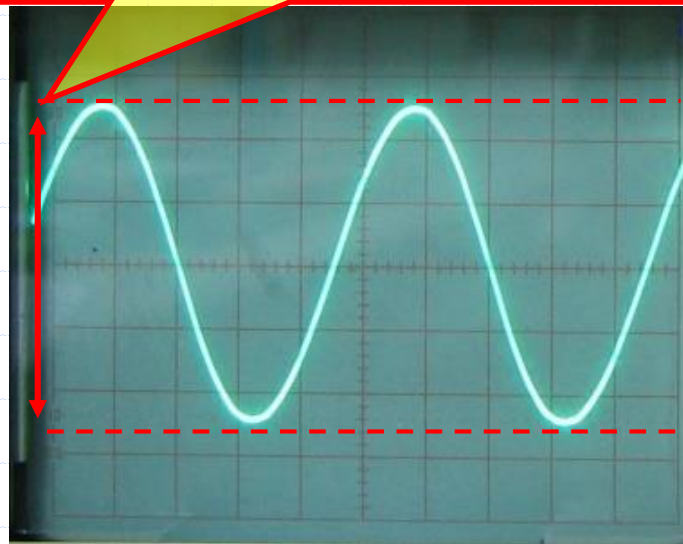

0.2V/DIV, 20uS/DIV

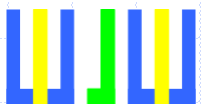

# 9-5A. 주파수에 따른 인덕터의 특성

- ✓ 주파수를 50kHz로 변경하고, 측정을 반복한다.

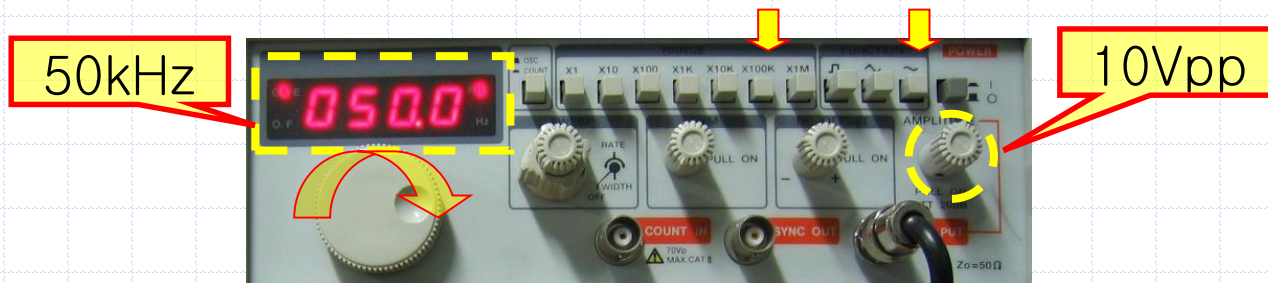

$$V_L : 4.9\text{칸} \times 2\text{V/DIV} = 9.8\text{Vpp}$$

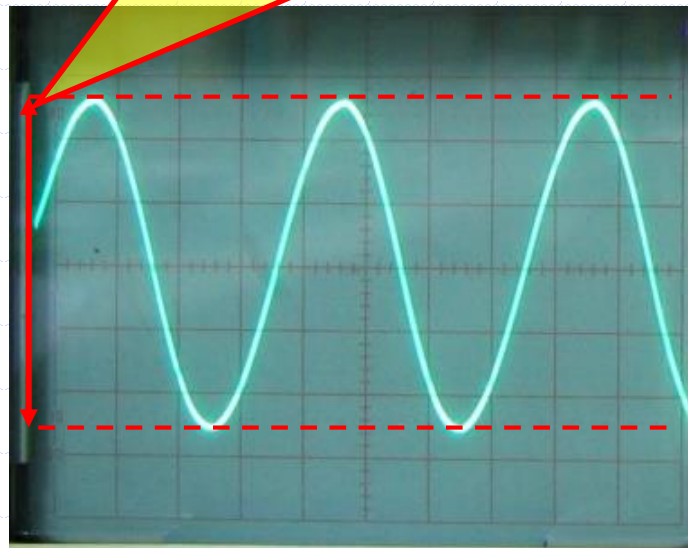

2V/DIV, 5uS/DIV

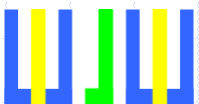

# 9-5A. 주파수에 따른 인덕터의 특성

- ✓ 주파수를 80kHz로 변경하고, 측정을 반복한다.

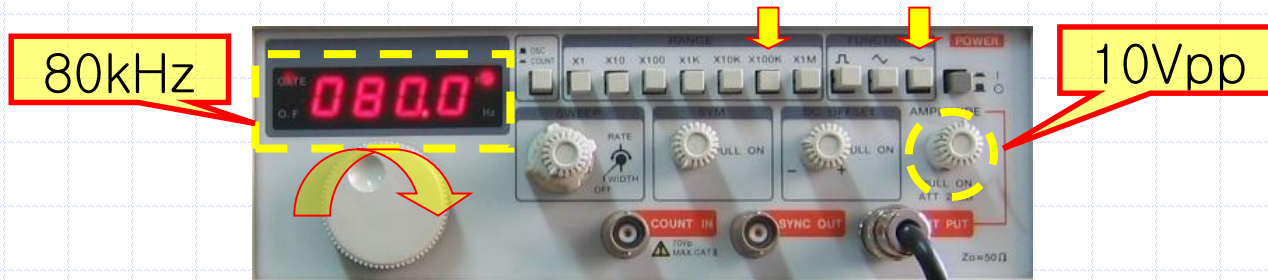

$$V_L : 5\text{칸} \times 2\text{V/DIV} = 10\text{Vpp}$$

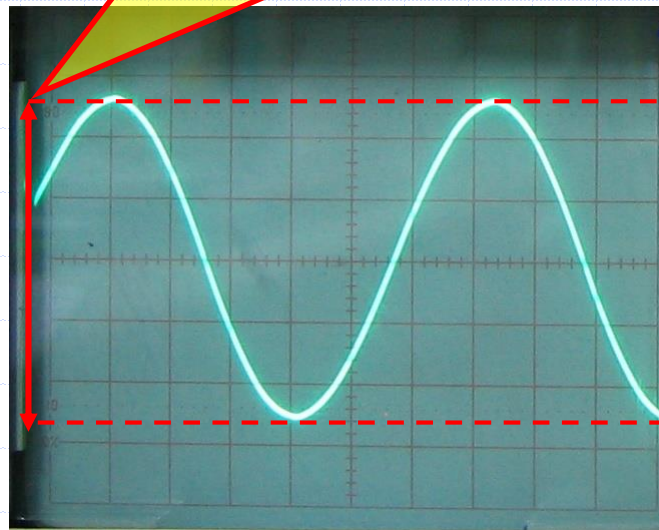

2V/DIV, 5 $\mu$ S/DIV

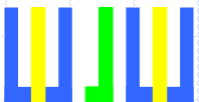



# 9-5A. 주파수에 따른 인덕터의 특성

$V_L$ 의 변화를 2V/DIV의 같은 크기로 비교

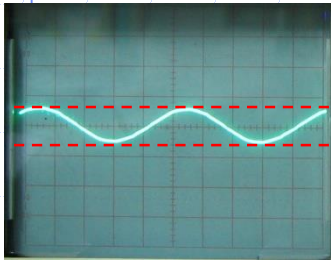

1kHz

이론 : 2.03Vpp

실험 : 2.20Vpp

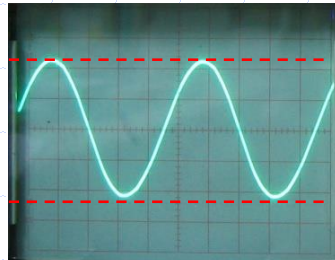

10kHz

이론 : 9.00Vpp

실험 : 9.00Vpp

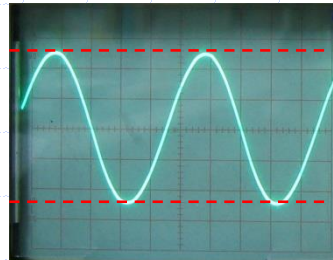

20kHz

이론 : 9.72Vpp

실험 : 9.80Vpp

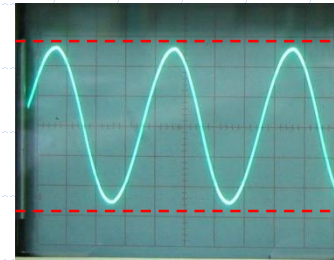

50kHz

이론 : 9.95Vpp

실험 : 9.80Vpp

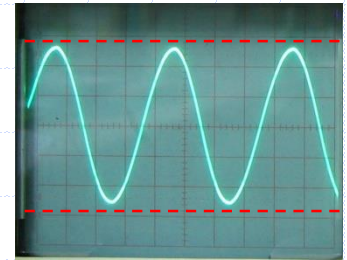

80kHz

이론 : 9.98Vpp

실험 : 10.0Vpp

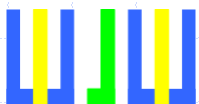

# 9-5B. 주파수에 따른 인덕터의 특성

- ✓ 인덕터를 1mH 로 바꾸어서 측정하라.

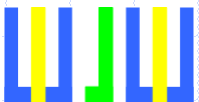
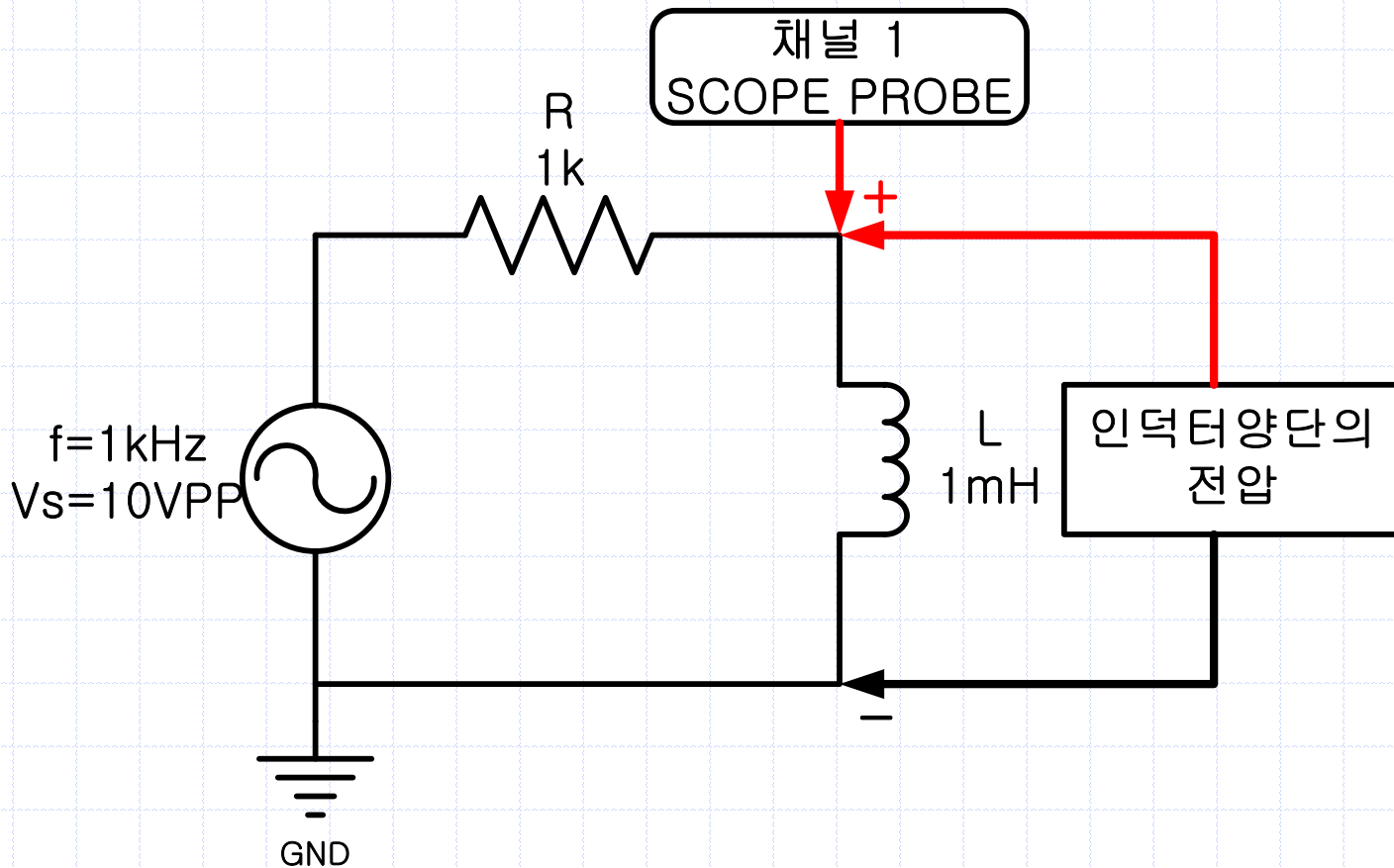

# 9-5B. 주파수에 따른 인덕터의 특성

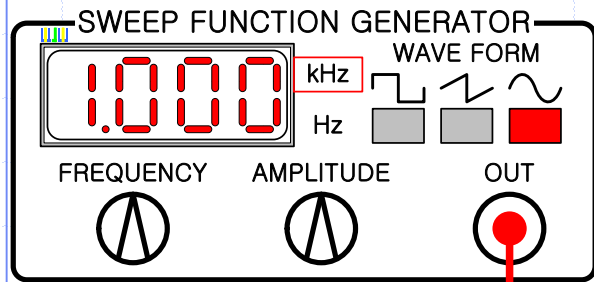

$f=1\text{kHz}$ ,  $V_s=10\text{Vpp}$

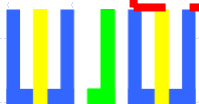
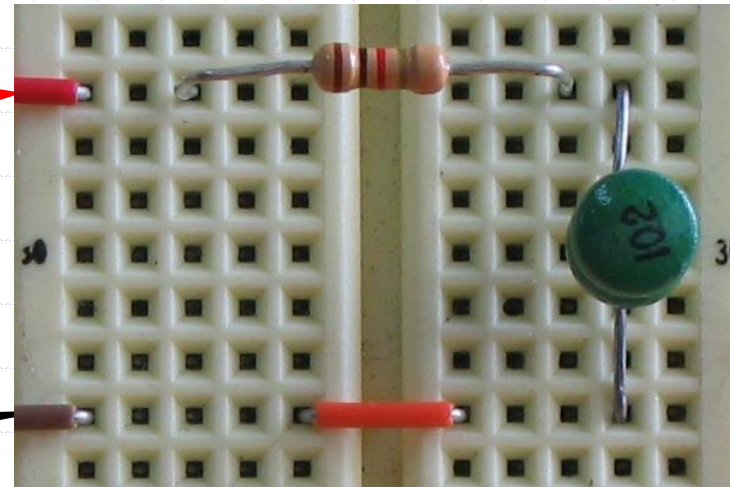
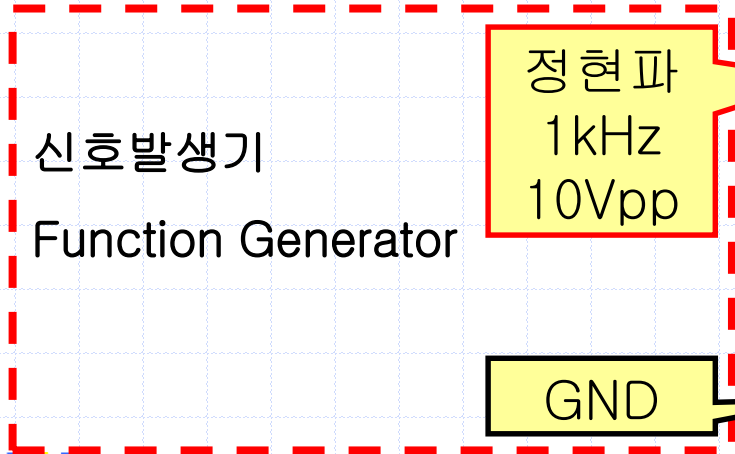
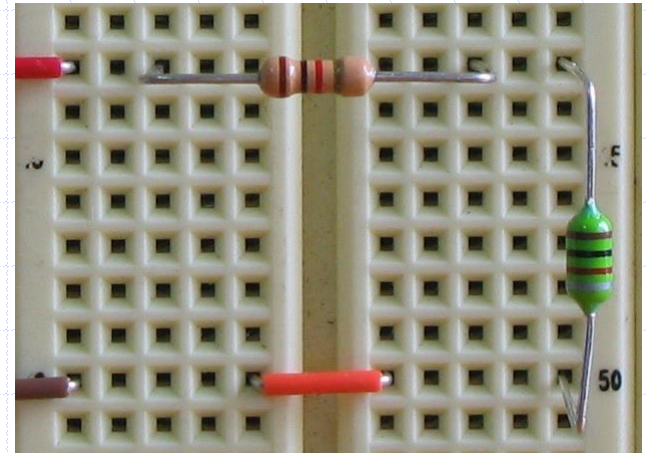
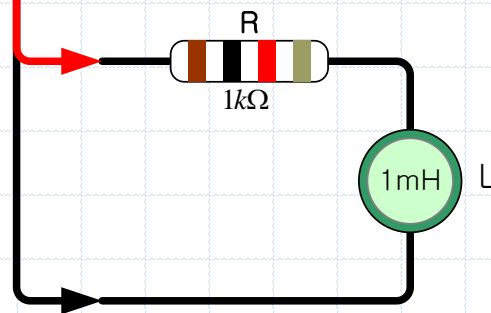

# 9-5B. 주파수에 따른 인덕터의 특성

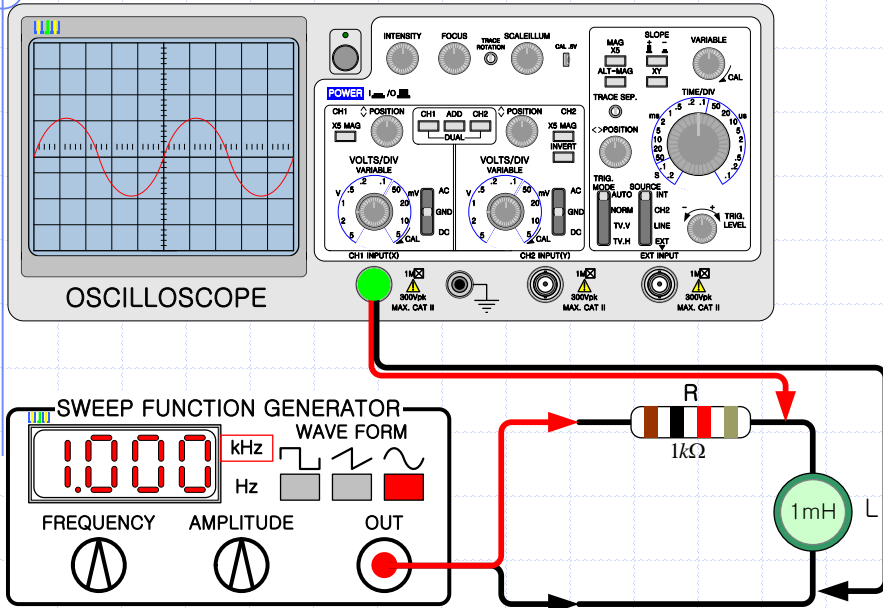

8칸 X 10mV/DIV = 80mVpp

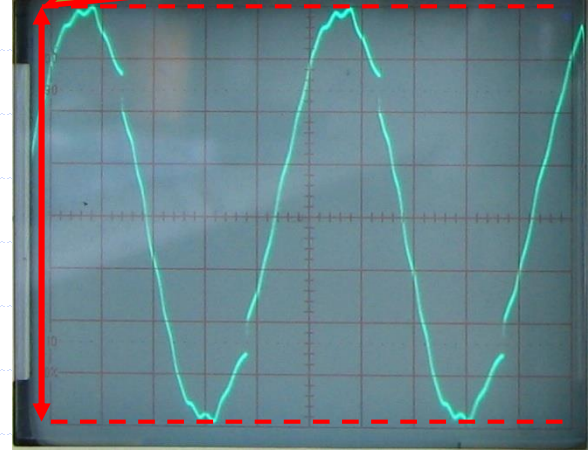

2V/DIV, 0.2mS/DIV

신호발생기  
 Function Generator

정현파  
 1kHz  
 10Vpp

GND

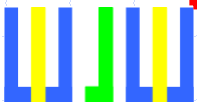
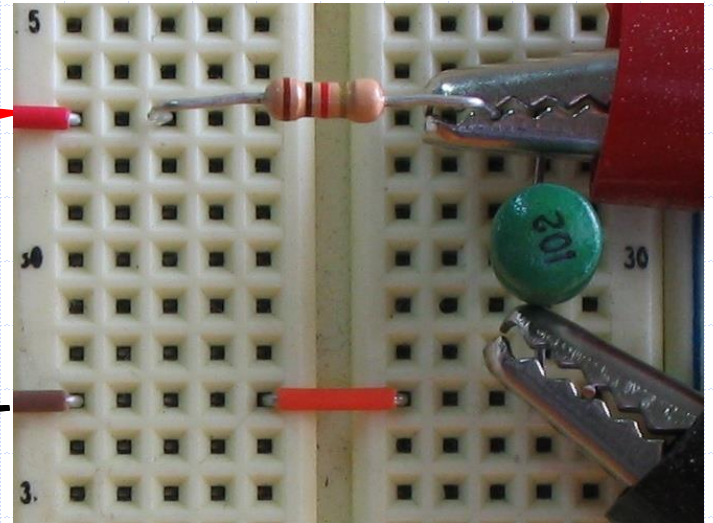

# 9-5B. 주파수에 따른 인덕터의 특성

- ✓ 주파수를 10kHz로 변경하고, 측정을 반복한다.

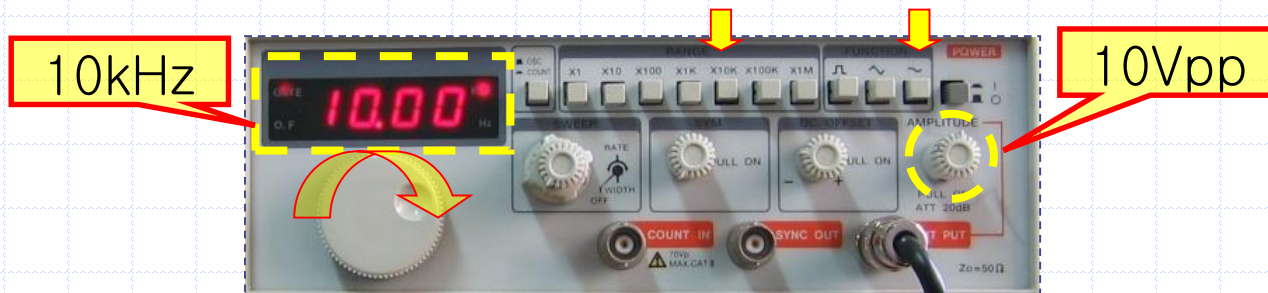

$$V_L : 6.5 \text{칸} \times 0.1 \text{V/DIV} = 0.65 \text{Vpp}$$

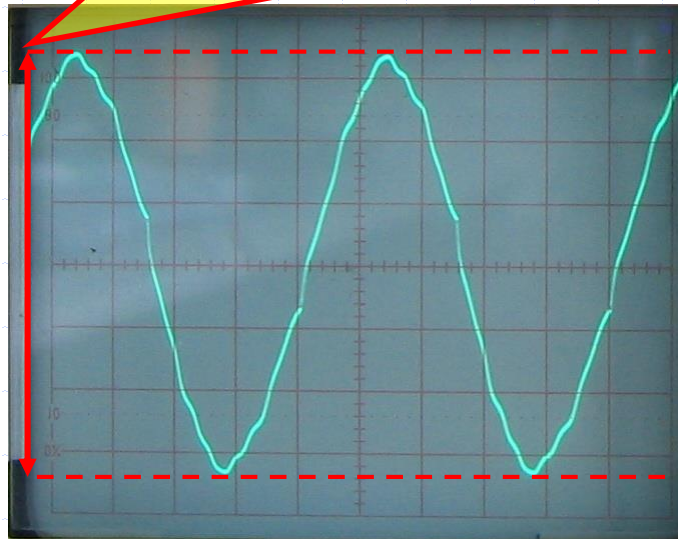

0.1V/DIV, 20uS/DIV

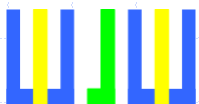

# 9-5B. 주파수에 따른 인덕터의 특성

- ✓ 주파수를 20kHz로 변경하고, 측정을 반복한다.

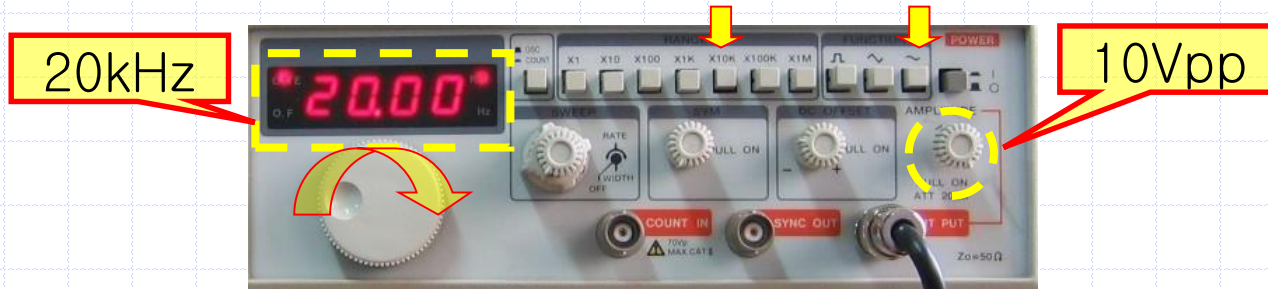

$$V_L : 6.5\text{칸} \times 0.2\text{V/DIV} = 1.3\text{Vpp}$$

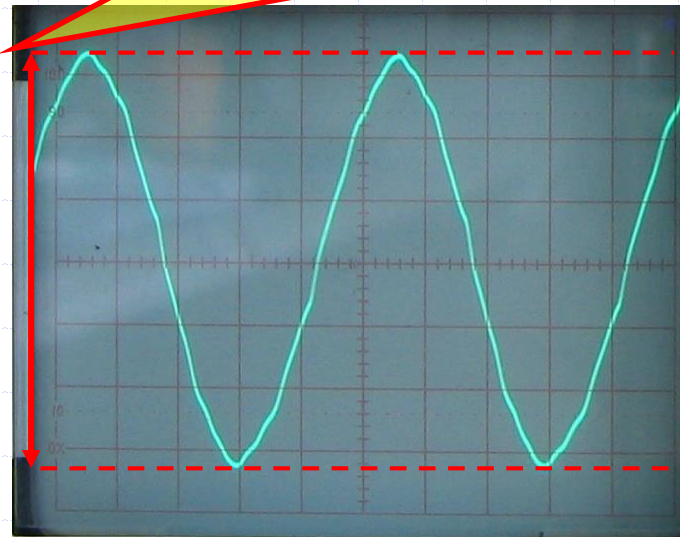

0.2V/DIV, 20uS/DIV

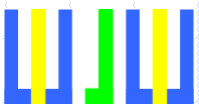

# 9-5B. 주파수에 따른 인덕터의 특성

- ✓ 주파수를 50kHz로 변경하고, 측정을 반복한다.

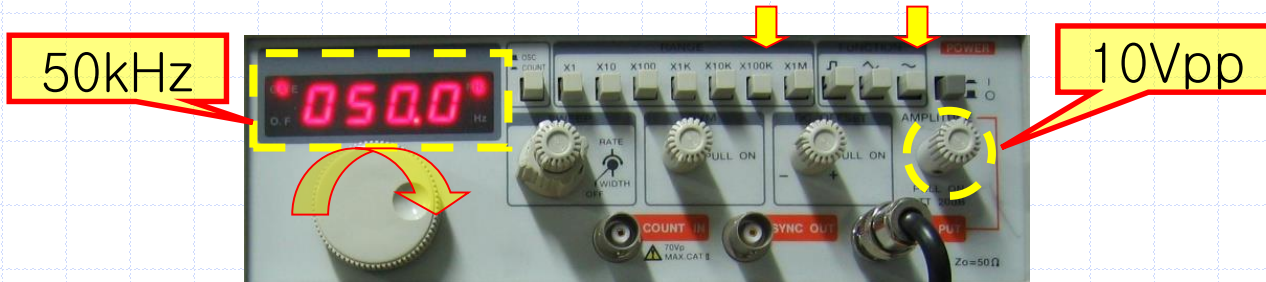

$$V_L : 6\text{칸} \times 0.5\text{V/DIV} = 3\text{Vpp}$$

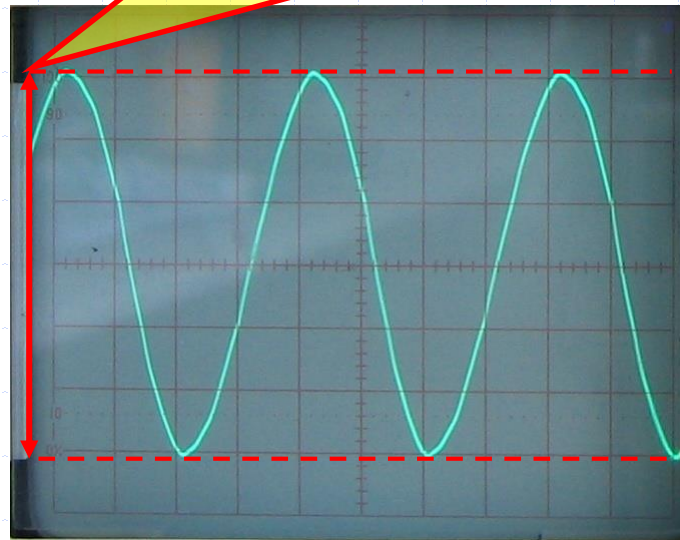

0.5V/DIV, 5 $\mu$ S/DIV

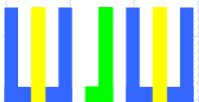

# 9-5B. 주파수에 따른 인덕터의 특성

- ✓ 주파수를 100kHz로 변경하고, 측정을 반복한다.

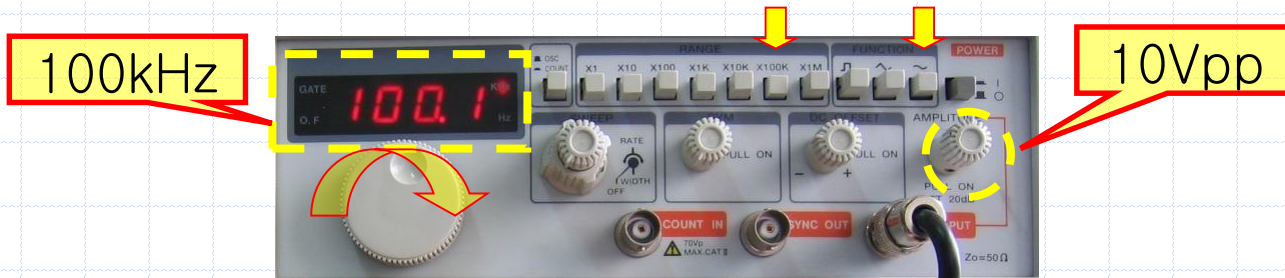

$$V_L : 5.6\text{칸} \times 1\text{V}/\text{DIV} = 5.6\text{Vpp}$$

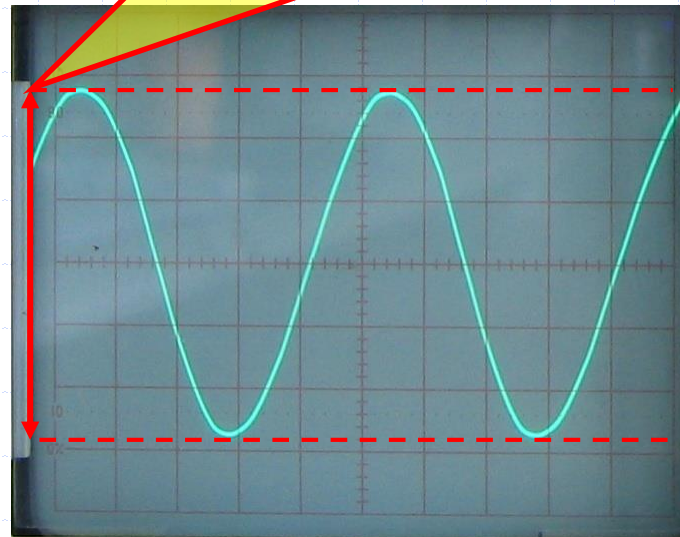

1V/DIV, 20uS/DIV

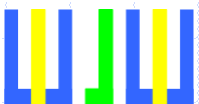



# 9-5B. 주파수에 따른 인덕터의 특성

$V_L$  의 변화를 2V/DIV의 같은 크기로 비교

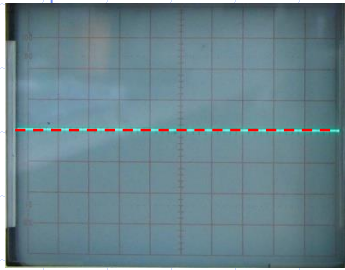

1kHz

이론 : 0.063Vpp

실험 : 0.080Vpp

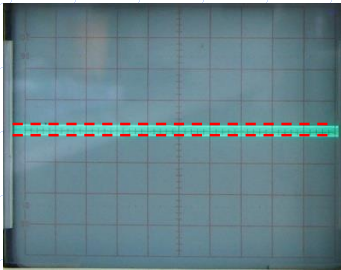

10kHz

이론 : 0.63Vpp

실험 : 0.65Vpp

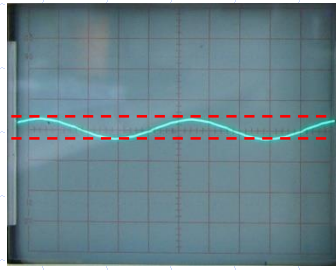

20kHz

이론 : 1.25Vpp

실험 : 1.30Vpp

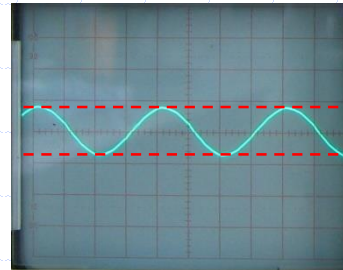

50kHz

이론 : 2.99Vpp

실험 : 3.00Vpp

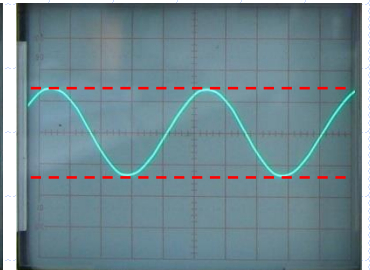

100kHz

이론 : 5.32Vpp

실험 : 5.60Vpp

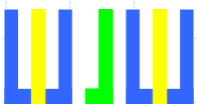

## 9-6. 인덕터의 전압, 전류 위상차

- 다음과 같이 회로를 연결하고, 오실로스코프의 CH 1과 CH 2를 이용하여 측정하라.

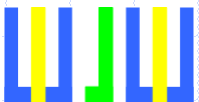
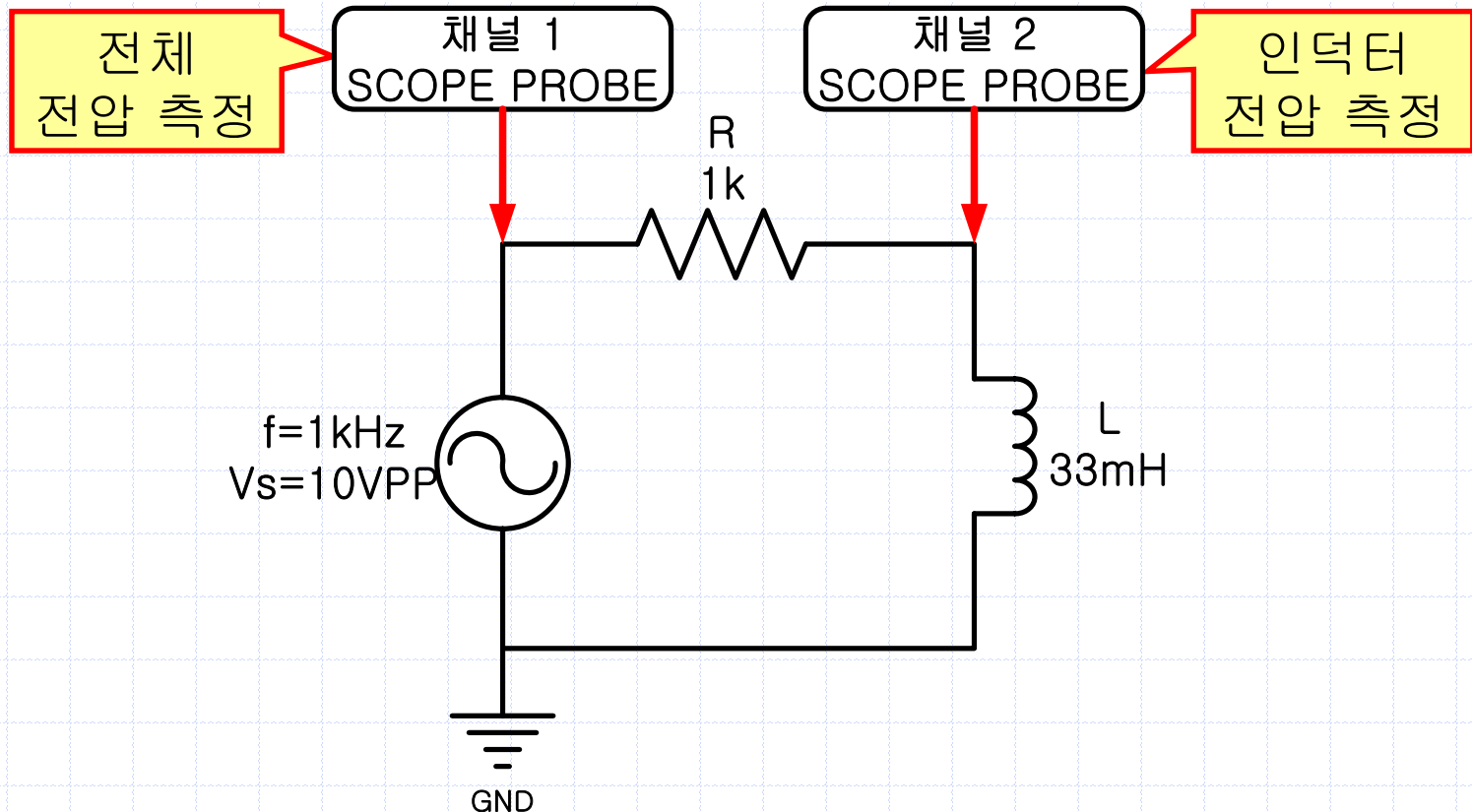

# 9-6. 인덕터의 전압, 전류 위상차

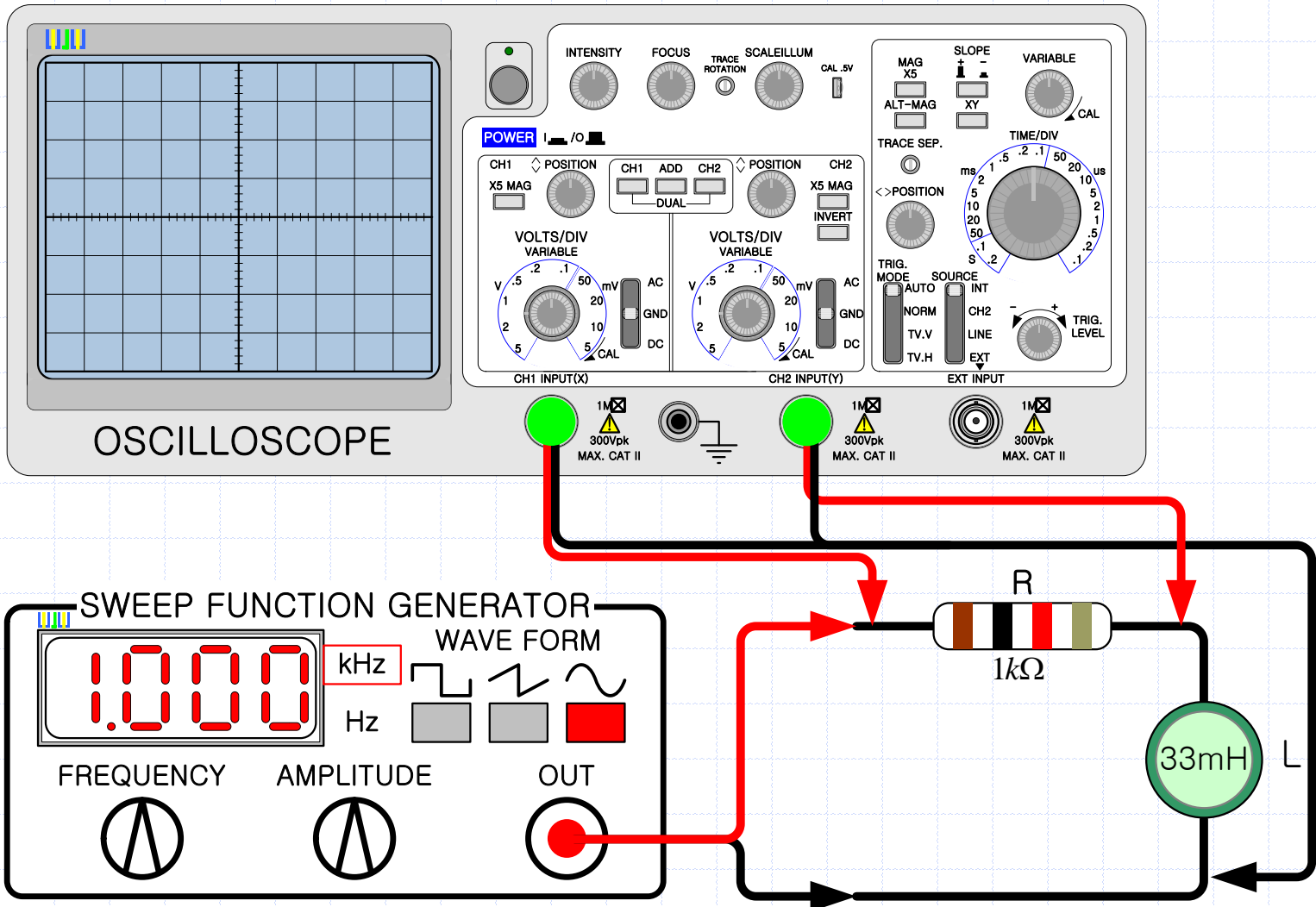

$f=1\text{kHz}$ ,  $V_s=10\text{Vpp}$

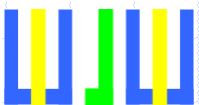

# 9-6. 인덕터의 전압, 전류 위상차

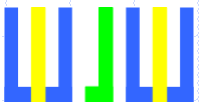
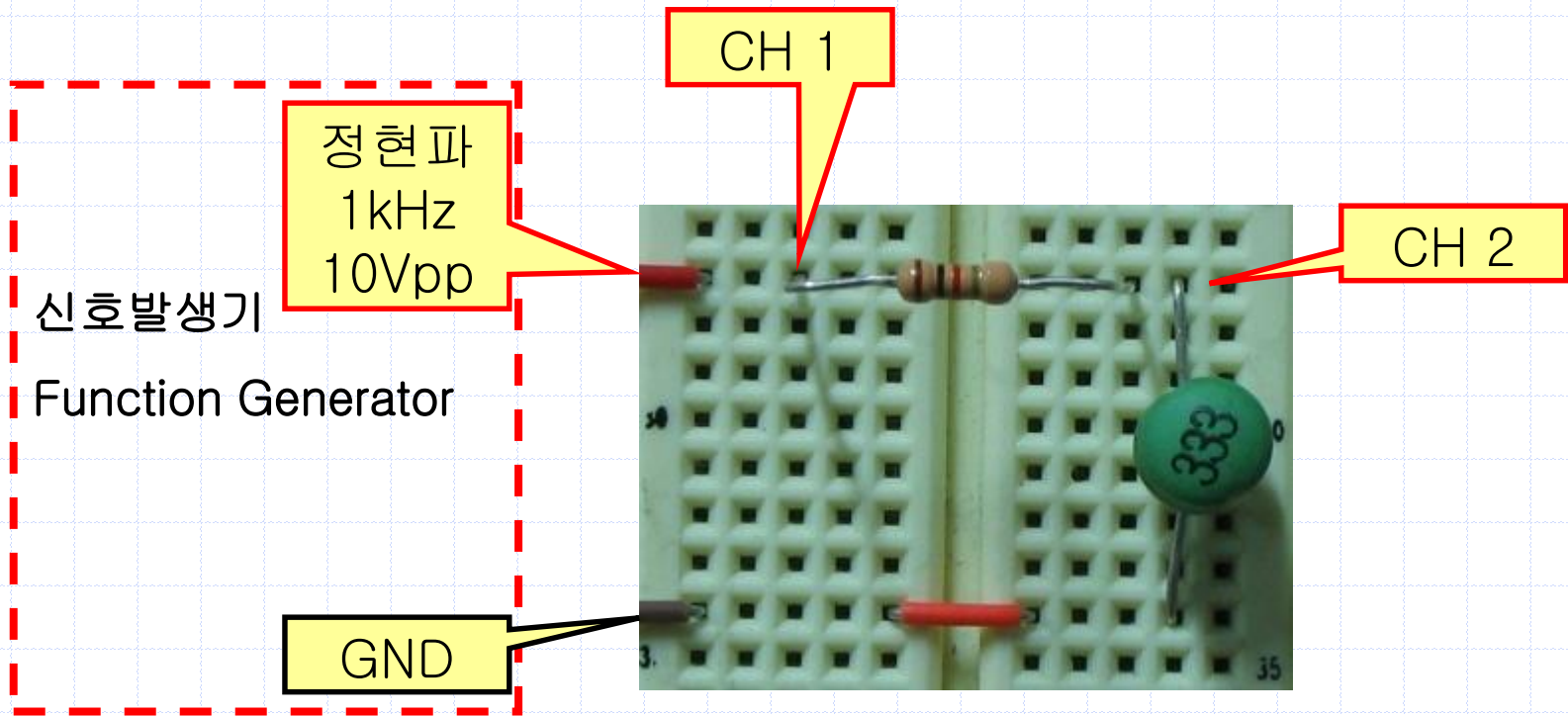

# 9-6. 인덕터의 전압, 전류 위상차

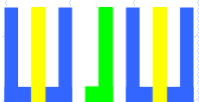
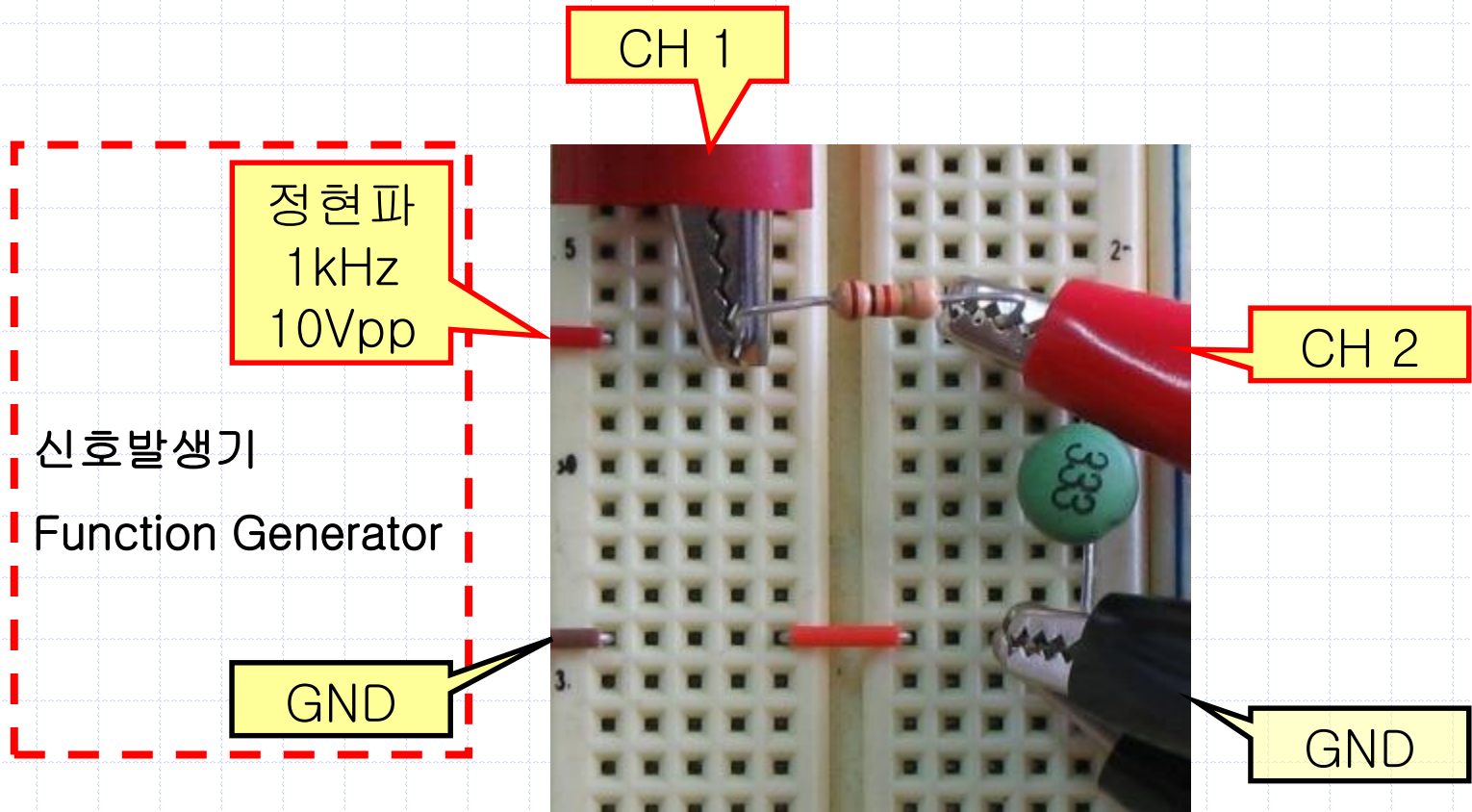

# 9-6. 인덕터의 전압, 전류 위상차



CH 1 : 전압 파형    CH 2 : 전압 파형

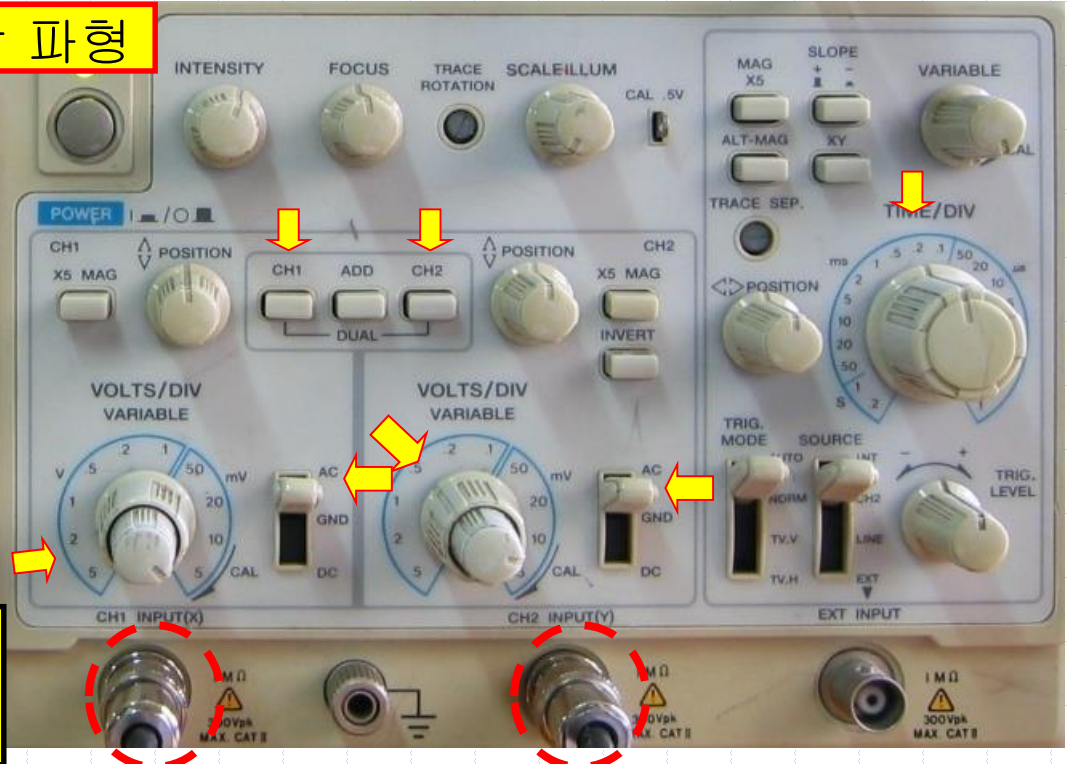
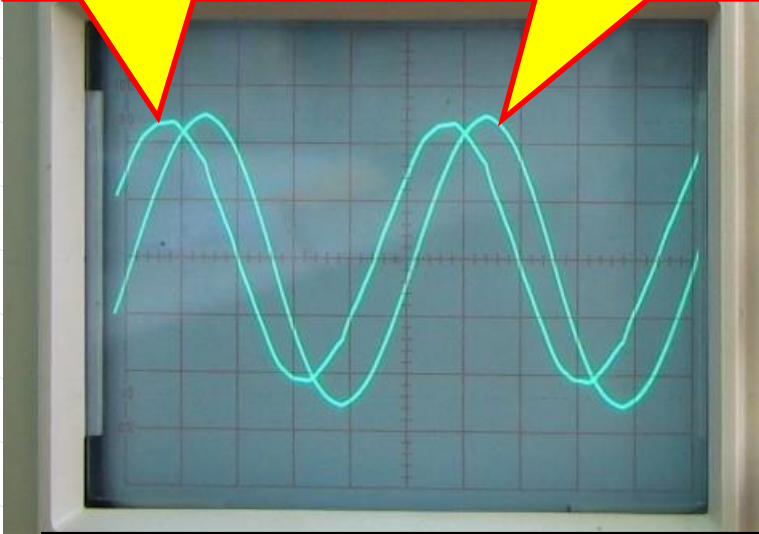

CH 1 : 2V/DIV, CH 2 : 10mV/DIV  
Time : 0.2mS/DIV

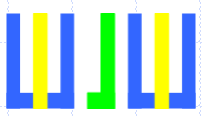

# 9-6. 인덕터의 전압, 전류 위상차

✓ 위상차를 측정하라

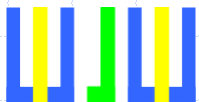
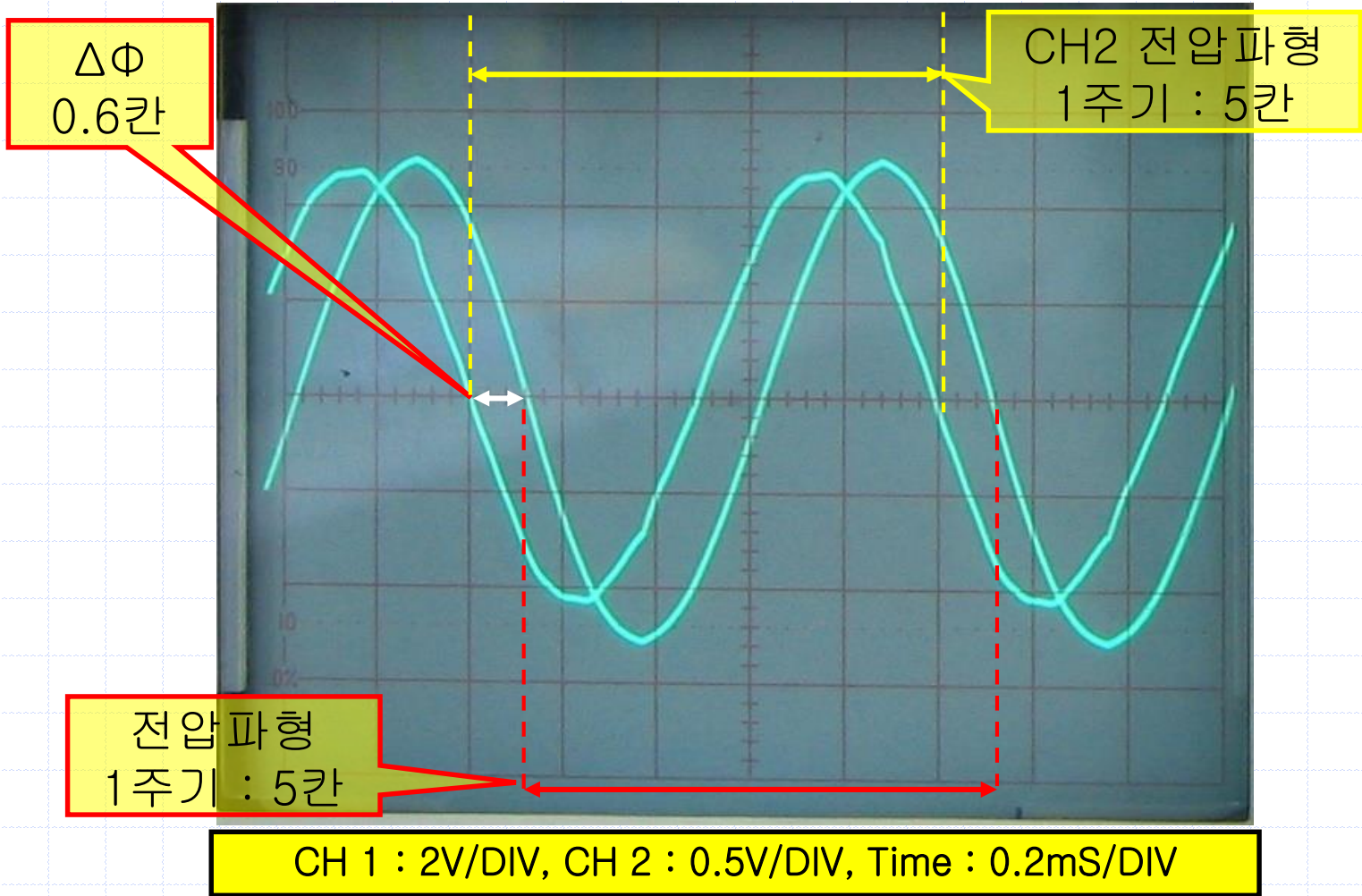

## 9-6. 인덕터의 전압, 전류 위상차

### ✓ 위상차

$$1T = 5\cancel{\text{칸}} \times 0.2\text{mSec} = 1\text{mSec}$$

$$\Delta t = 0.6\cancel{\text{칸}} \times 0.2\text{mSec} = 0.12\text{mSec}$$

$$1\text{mSec} : 0.12\text{mSec} = 360^\circ : \Delta\theta$$

$$\Delta\theta = 43.2^\circ$$

### ✓ 전압과 전류의 크기

$$\begin{aligned} X_L &= \omega L = 2\pi fL \\ &= 2\pi \times 1,000\text{Hz} \times 33 \times 10^{-3}\text{H} \\ &= 207.345\Omega \end{aligned}$$

$$\begin{aligned} Z &= R + jX_L = 1,000 + j207.345[\Omega] \\ &= 1021.27 \angle +11.714^\circ[\Omega] \end{aligned}$$

$$v_S = 10V_{PP} \angle 0^\circ$$

$$\begin{aligned} i_C &= \frac{v_S}{Z} = \frac{10V_{PP} \angle 0^\circ}{1021.27 \angle +11.714^\circ[\Omega]} \\ &= 9.792\text{mA}_{PP} \angle -11.714^\circ \end{aligned}$$

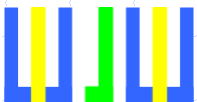



# 9-7A. 인덕터의 AC, DC 특성

- 회로를 다음과 같이 연결하고, 오실로스코프를 이용하여 각 지점의 전압을 측정한다.

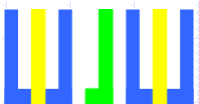
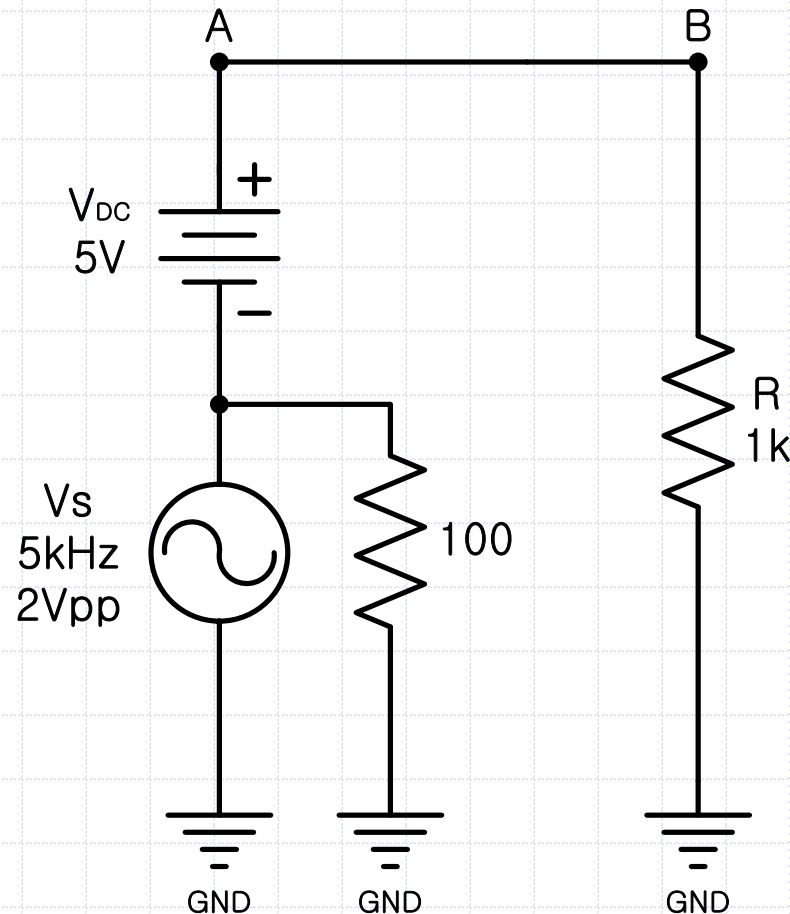

# 9-7A. 인덕터의 AC, DC 특성

+5V

직류전원장치  
DC Power Supply

GND

정현파  
5kHz  
2Vpp

신호발생기  
Function Generator

GND

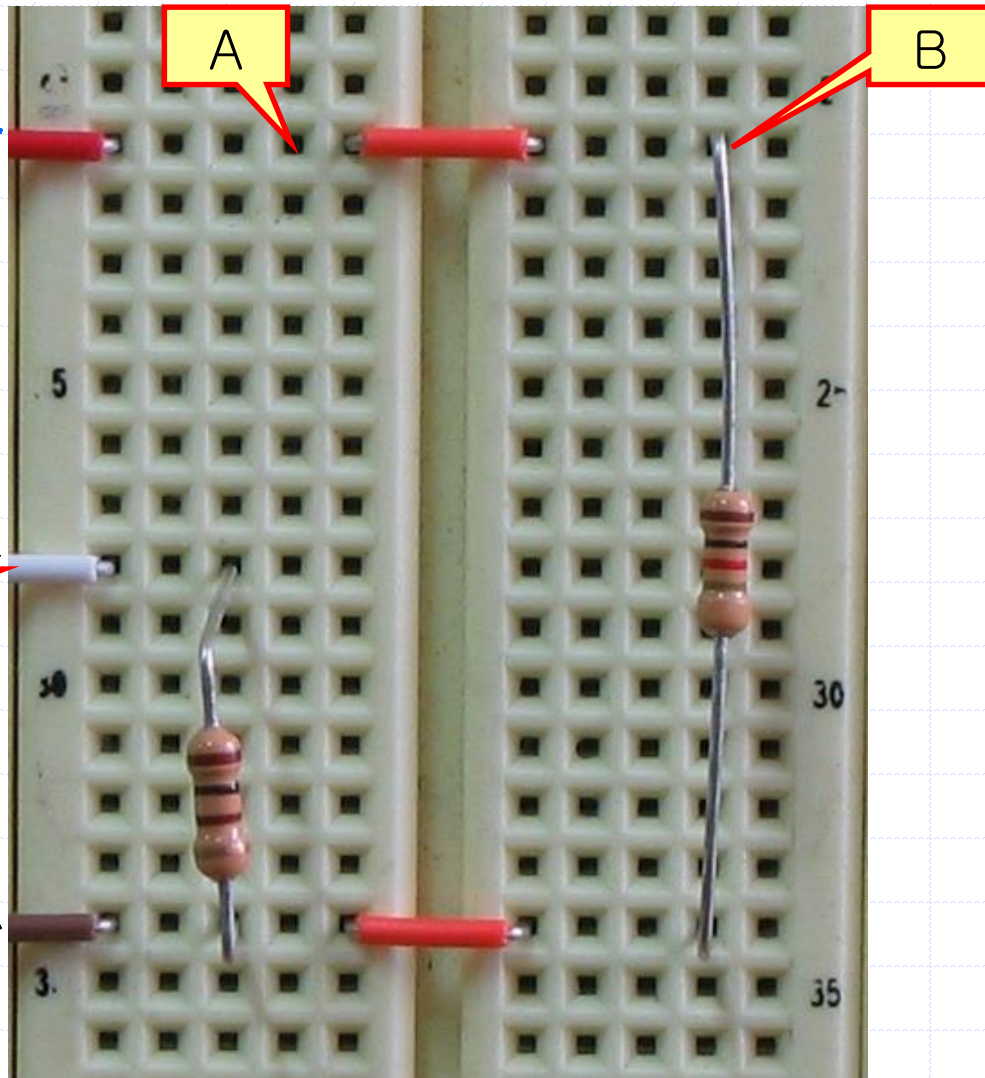

# 9-7A. 인덕터의 AC, DC 특성

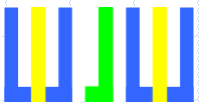
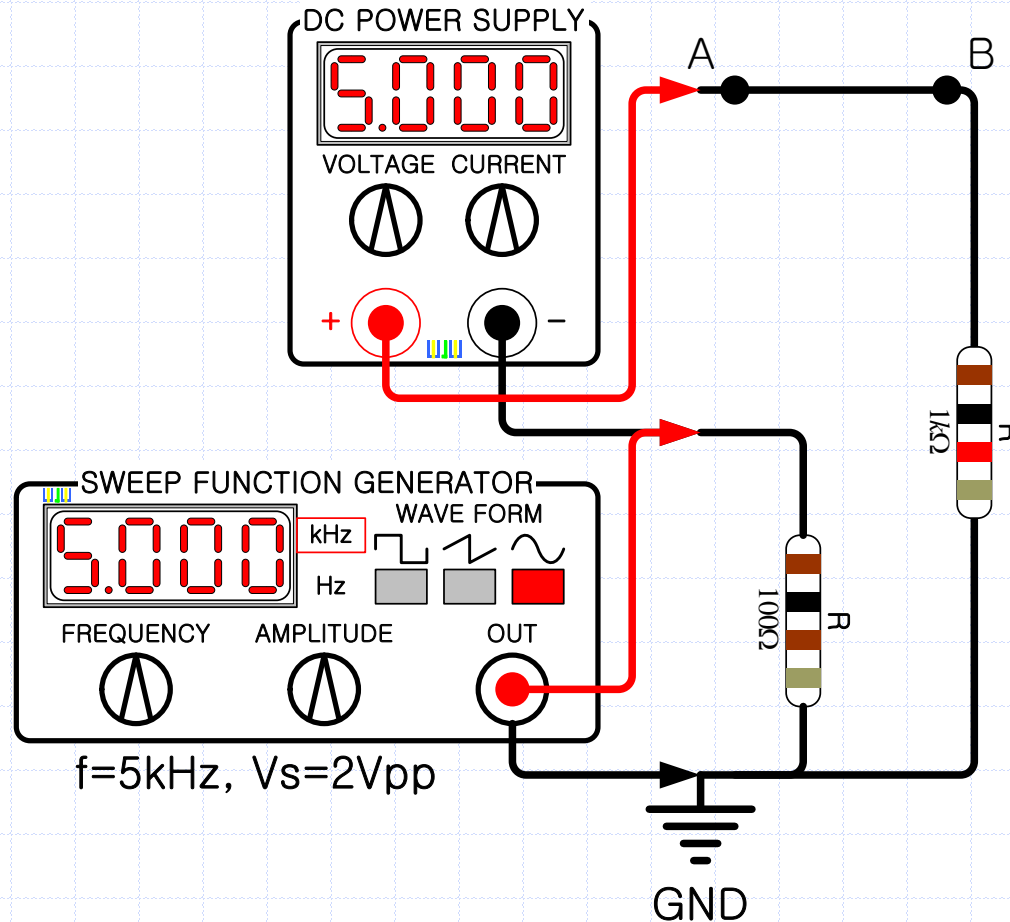

# 9-7A. 인덕터의 AC, DC 특성

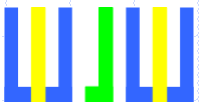
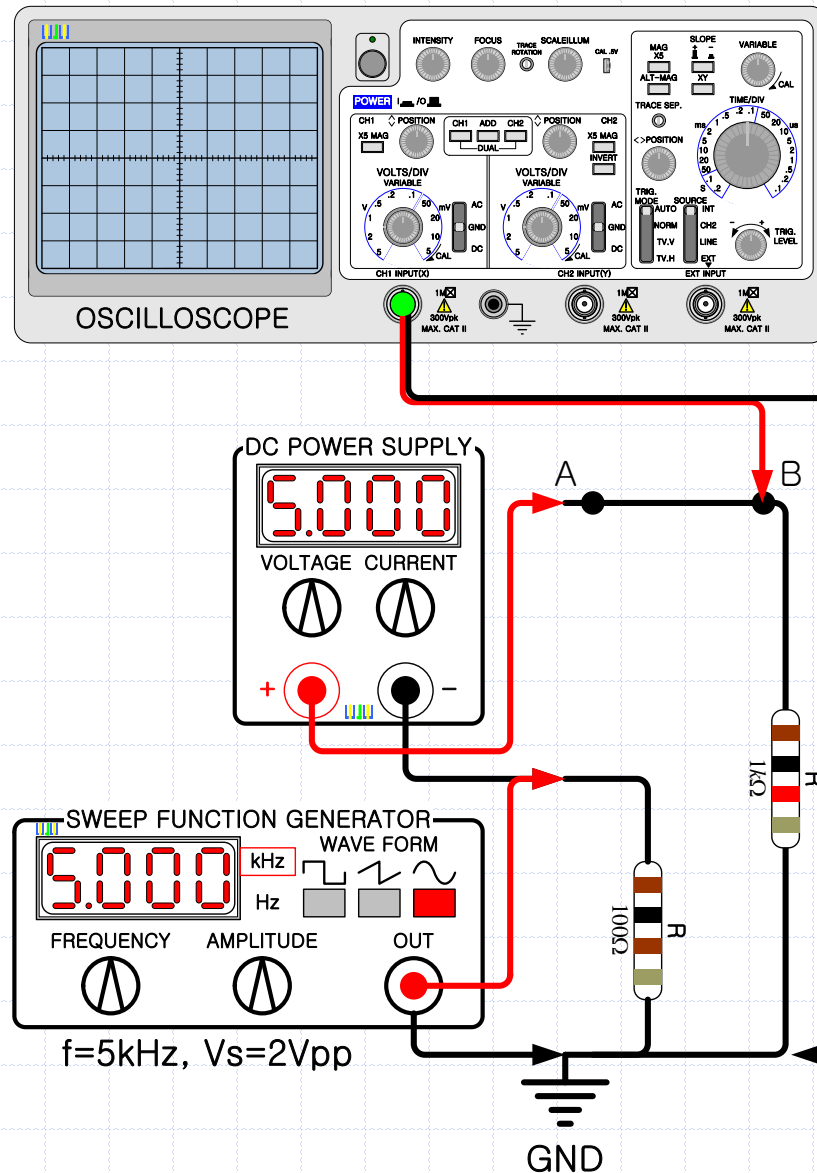

# 9-7A. 인덕터의 AC, DC 특성

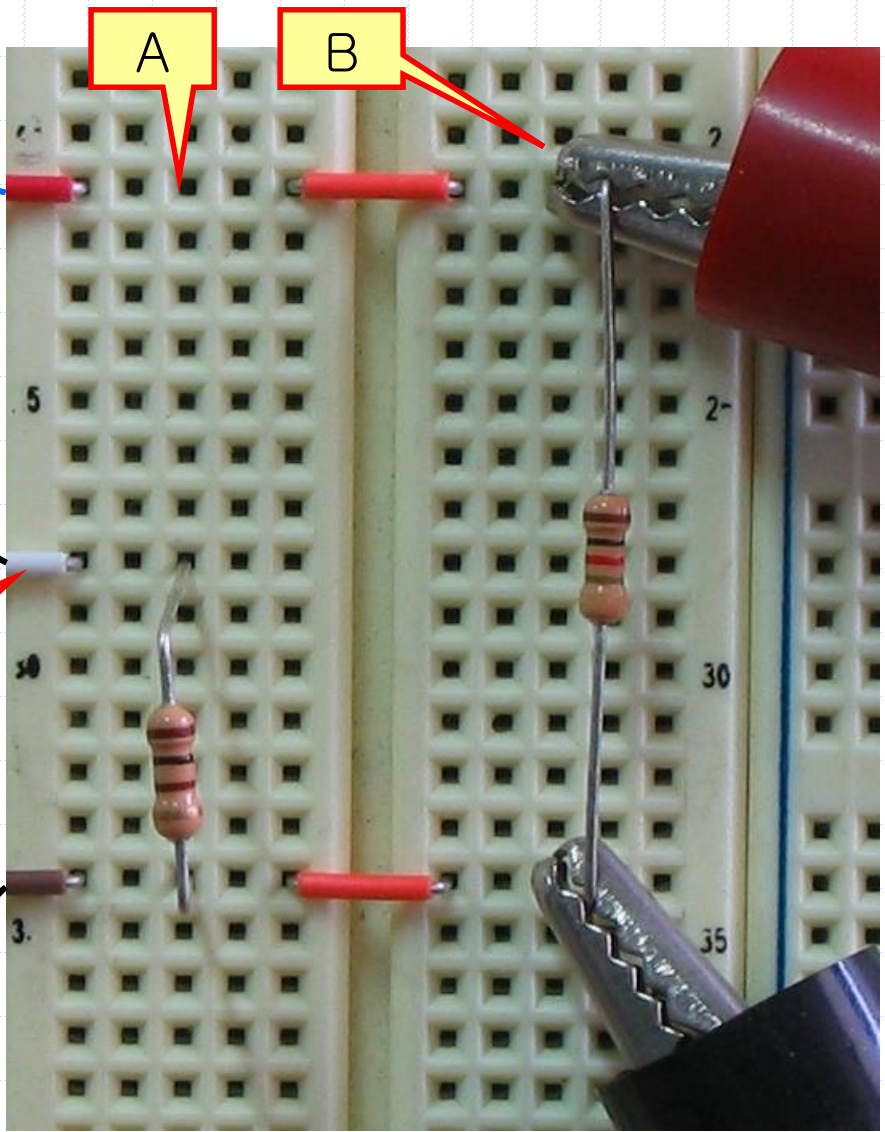
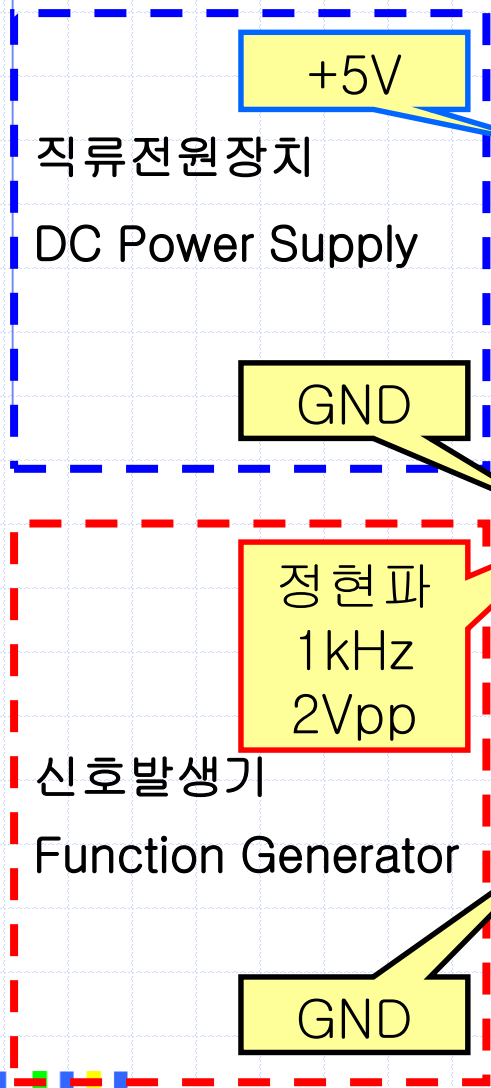

# 9-7A. 인덕터의 AC, DC 특성

✓ AC 측정

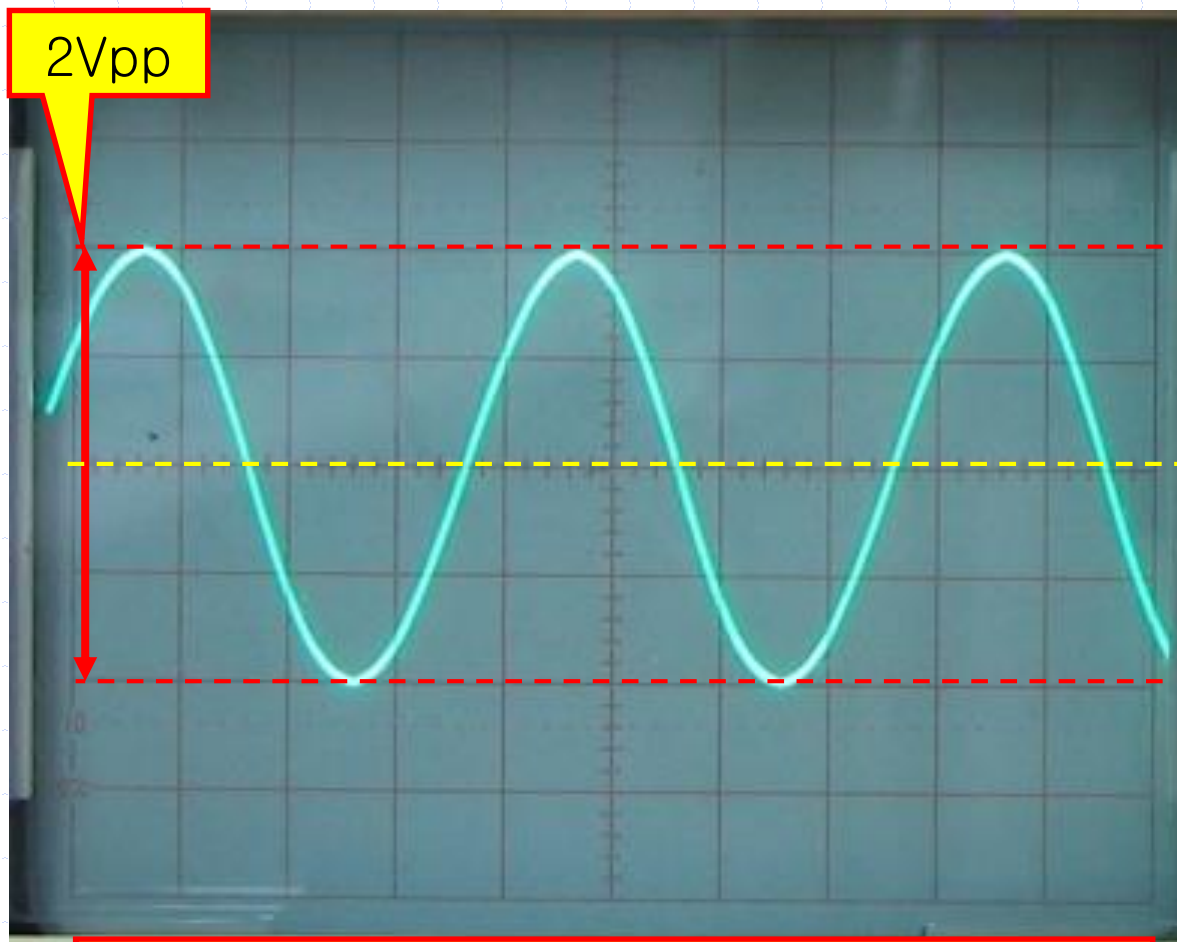

CH 1 : 0.5V/DIV, Time : 50uS/DIV

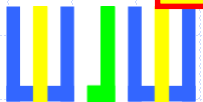

# 9-7A. 인덕터의 AC, DC 특성

✓ AC + DC 측정

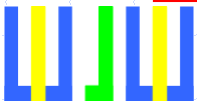
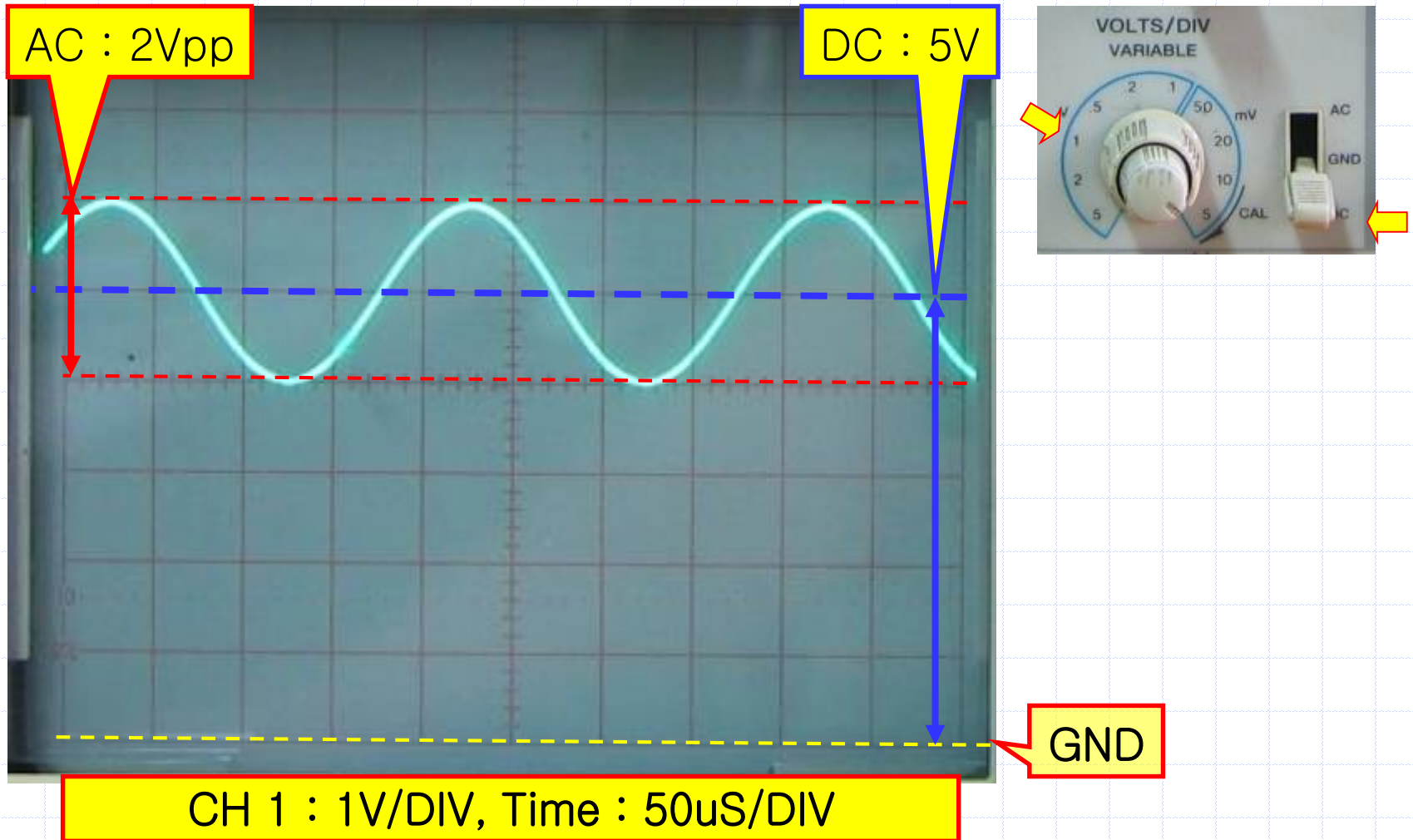

## 9-7B. 인덕터의 AC, DC 특성

- ✓ 앞의 회로에 커패시터를 다음과 같이 연결하고, 오실로스코프를 이용하여 각 지점의 전압을 측정한다.

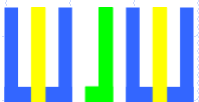
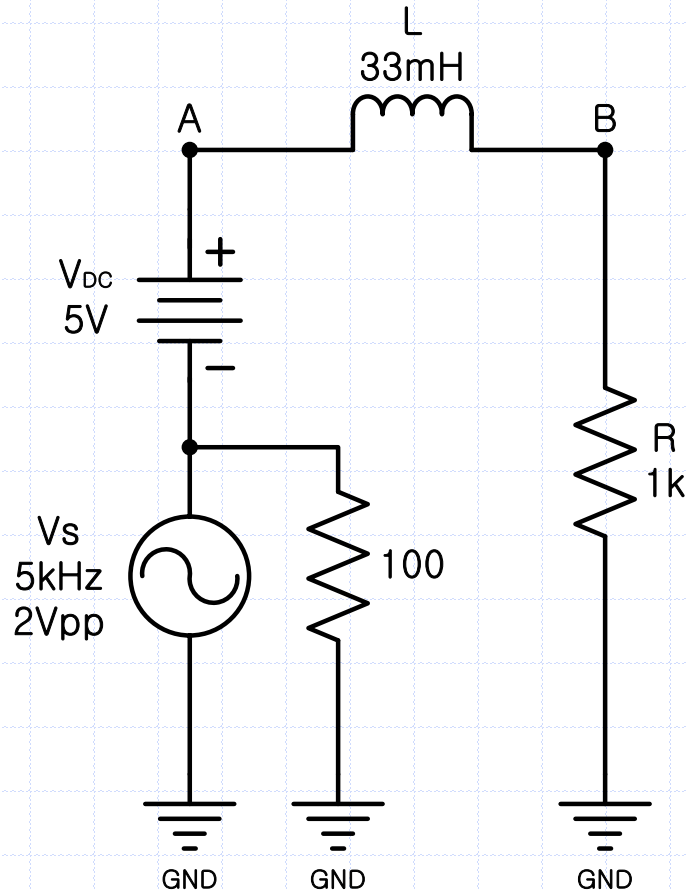



# 9-7B. 인덕터의 AC, DC 특성

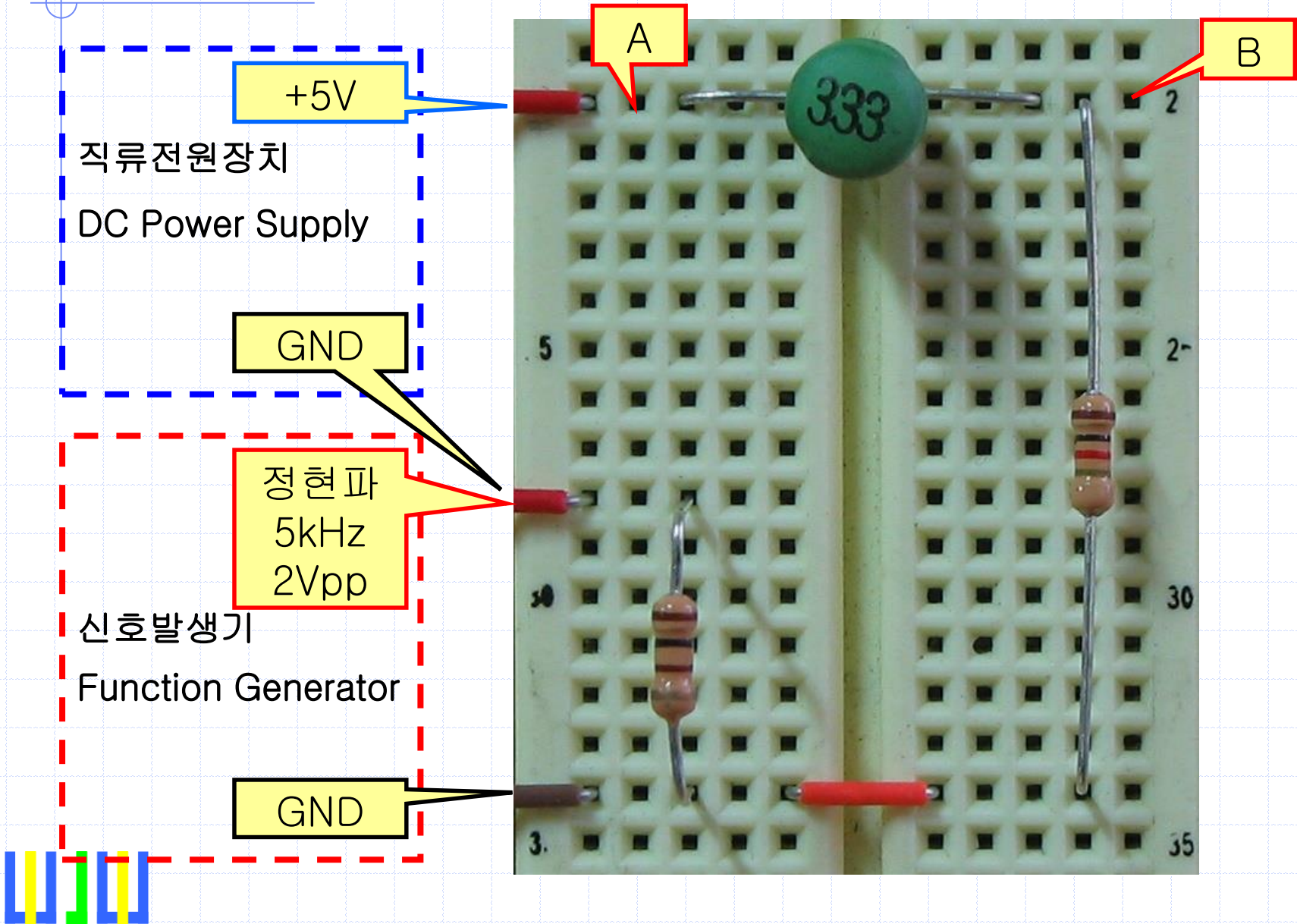

# 9-7B. 인덕터의 AC, DC 특성

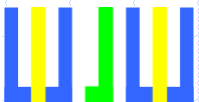
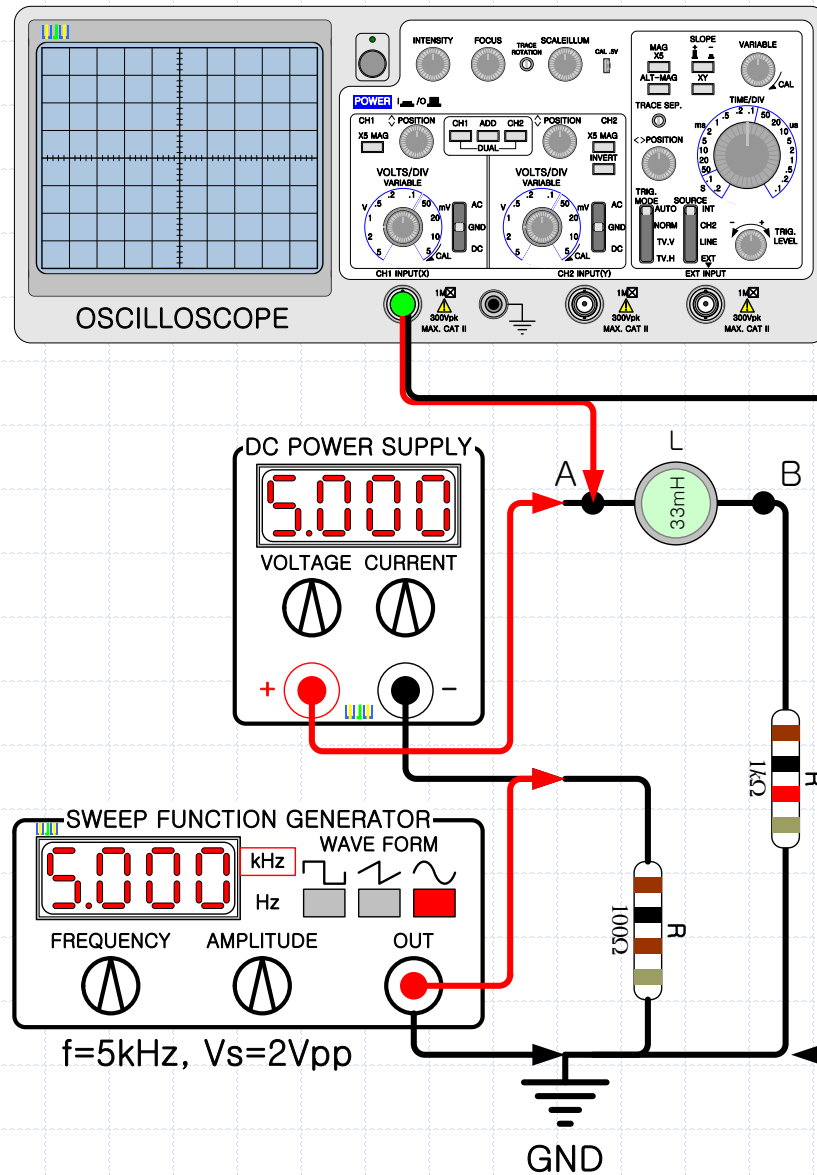

# 9-7B. 인덕터의 AC, DC 특성

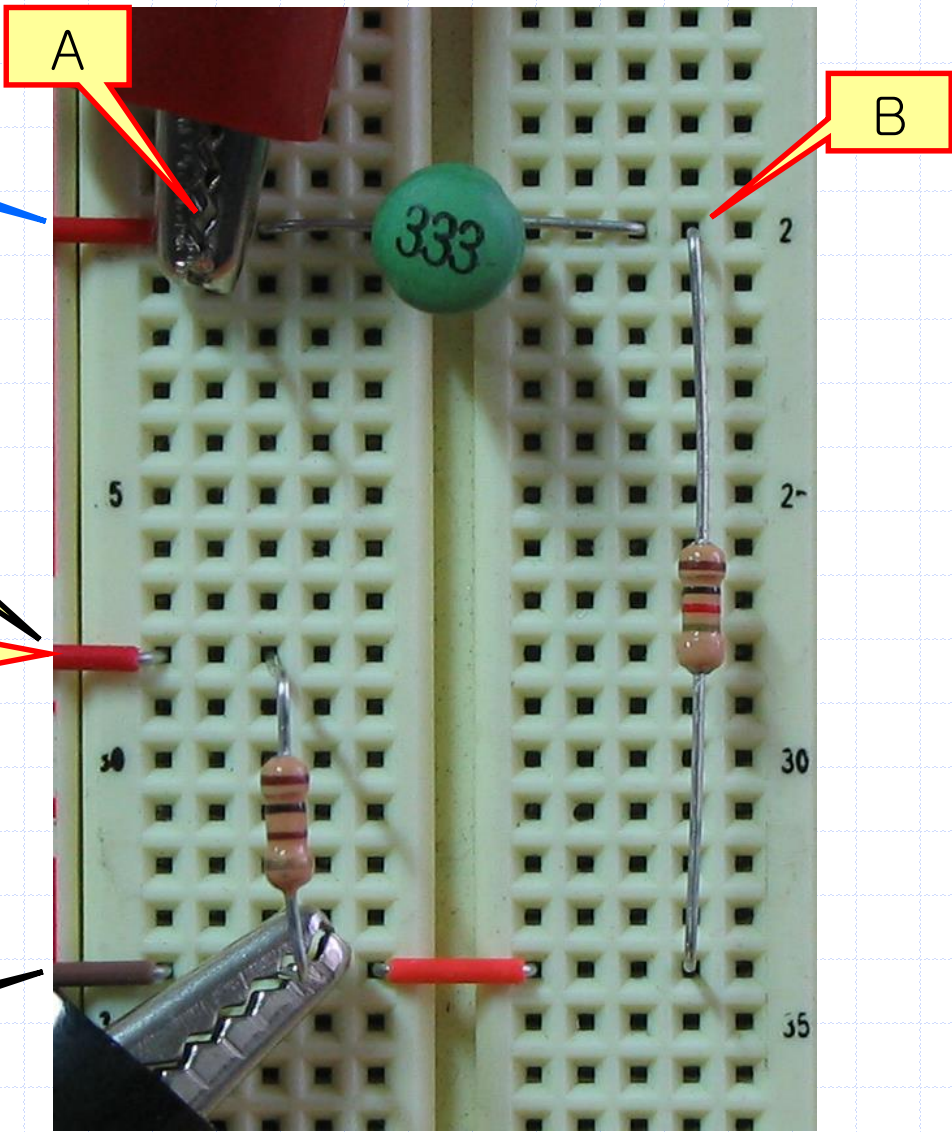
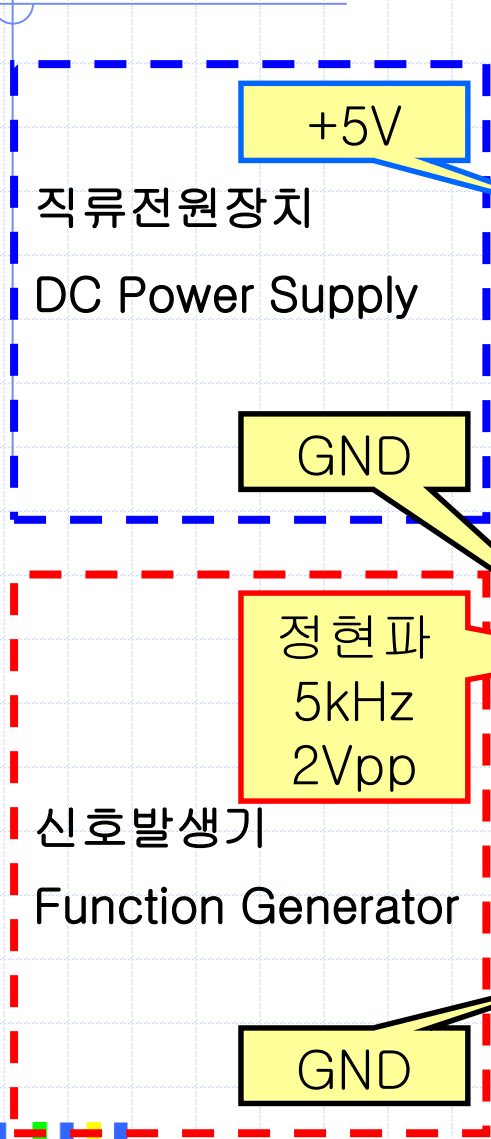

# 9-7B. 인덕터의 AC, DC 특성

✓ AC 측정

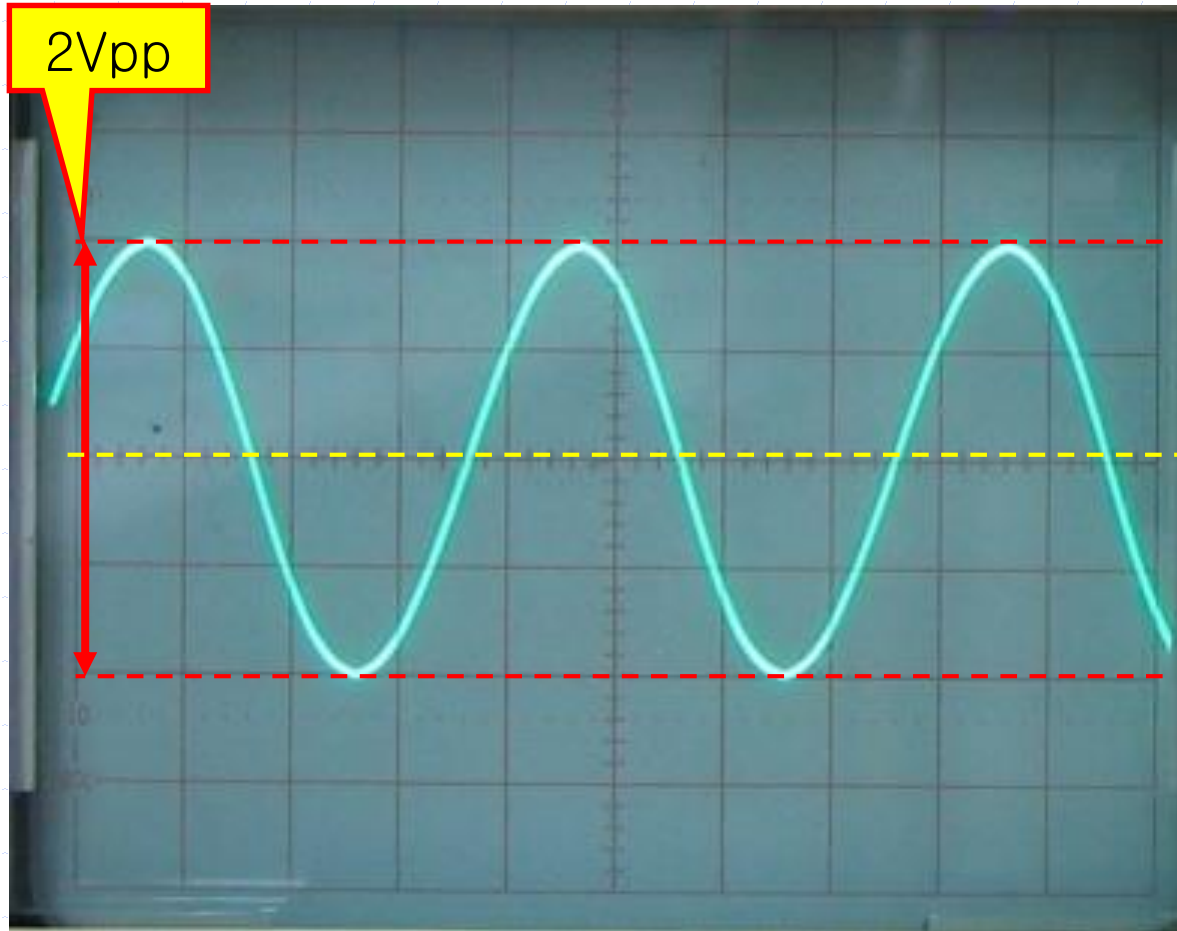

CH 1 : 0.5V/DIV, Time : 50uS/DIV

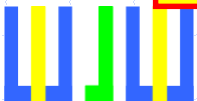

# 9-7B. 인덕터의 AC, DC 특성

✓ AC + DC 측정

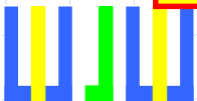
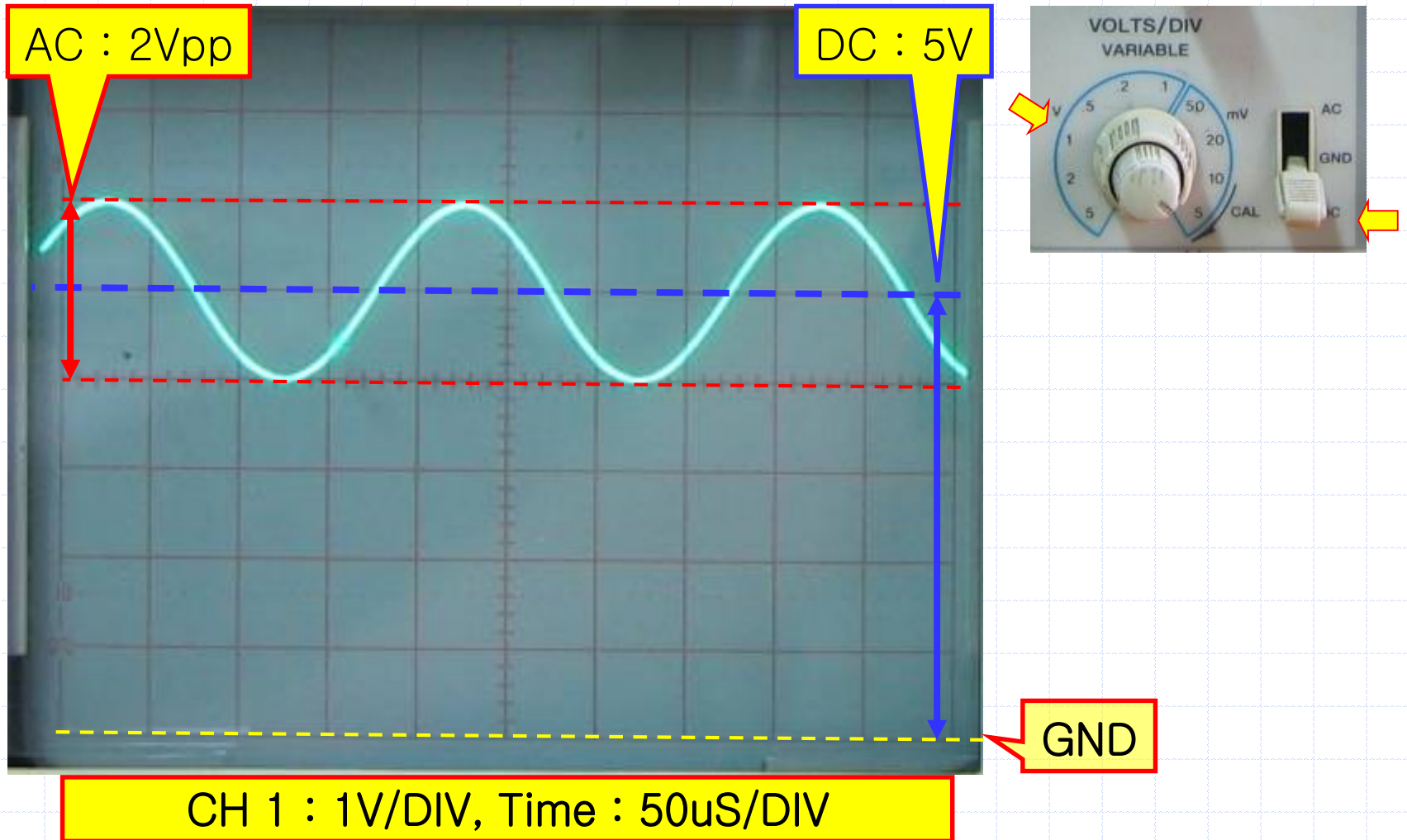

# 9-7B. 인덕터의 AC, DC 특성

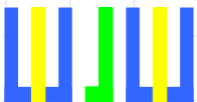
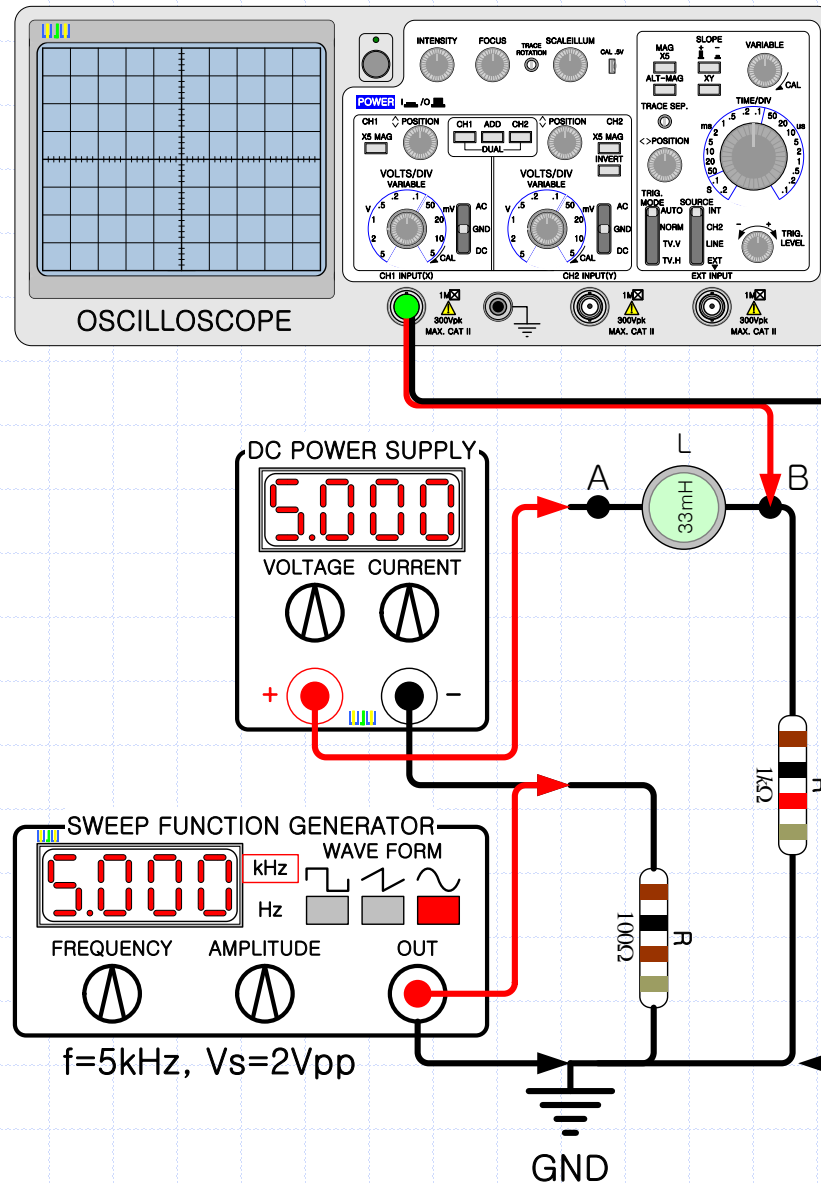

# 9-7B. 인덕터의 AC, DC 특성

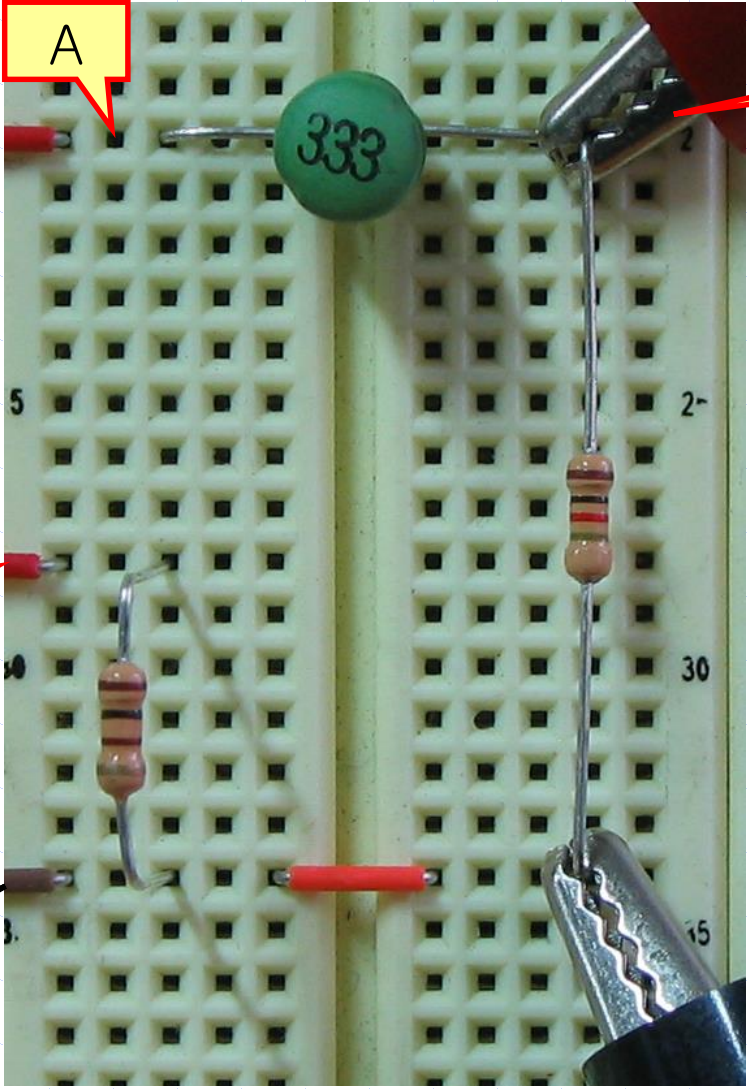
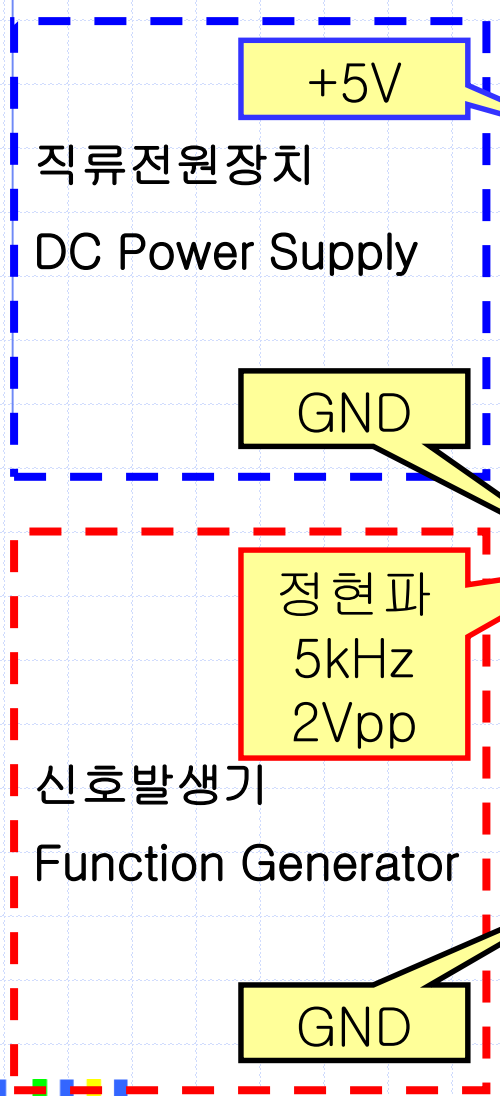

# 9-7B. 인덕터의 AC, DC 특성

✓ AC 측정

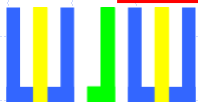
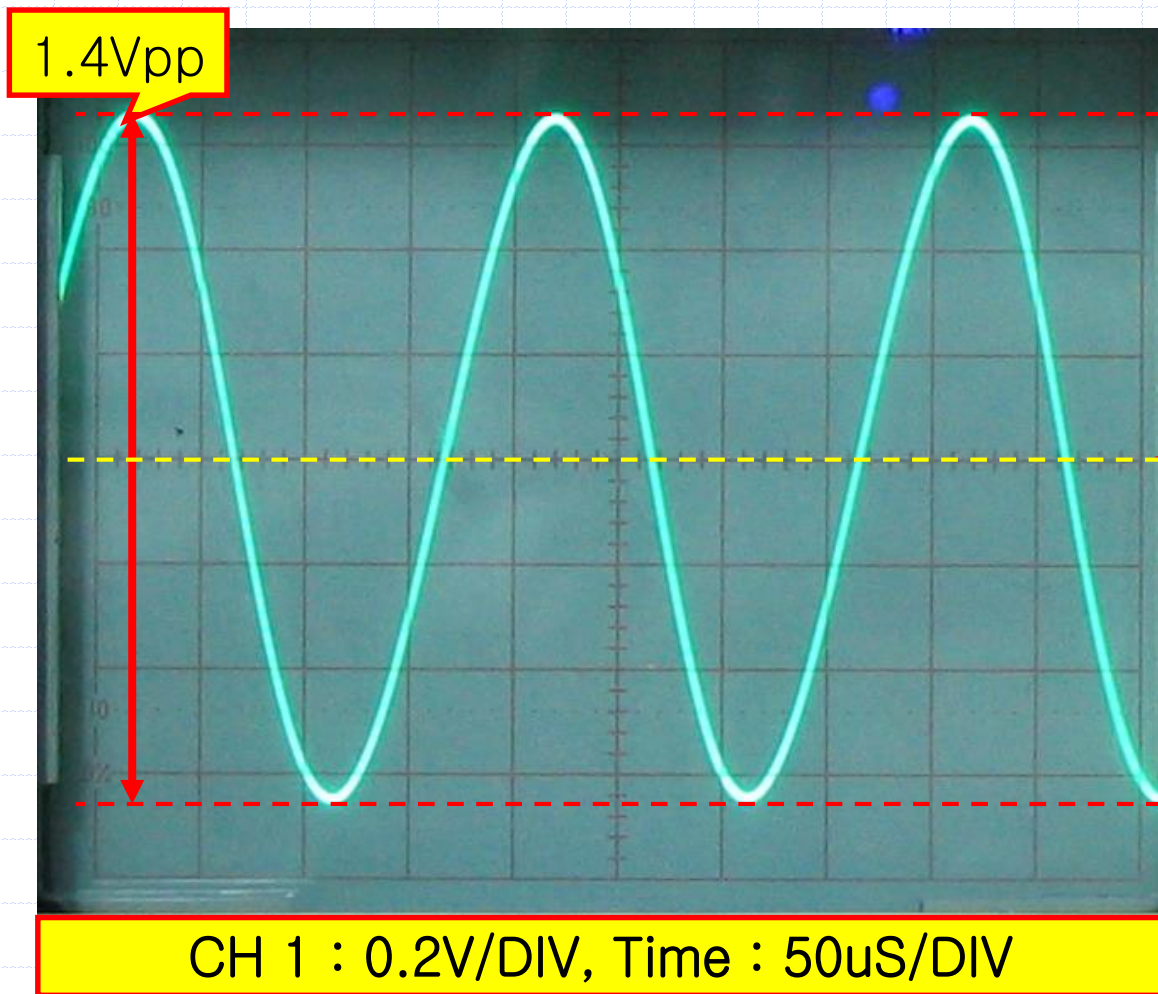



# 9-7B. 인덕터의 AC, DC 특성

✓ AC + DC 측정

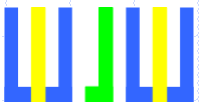
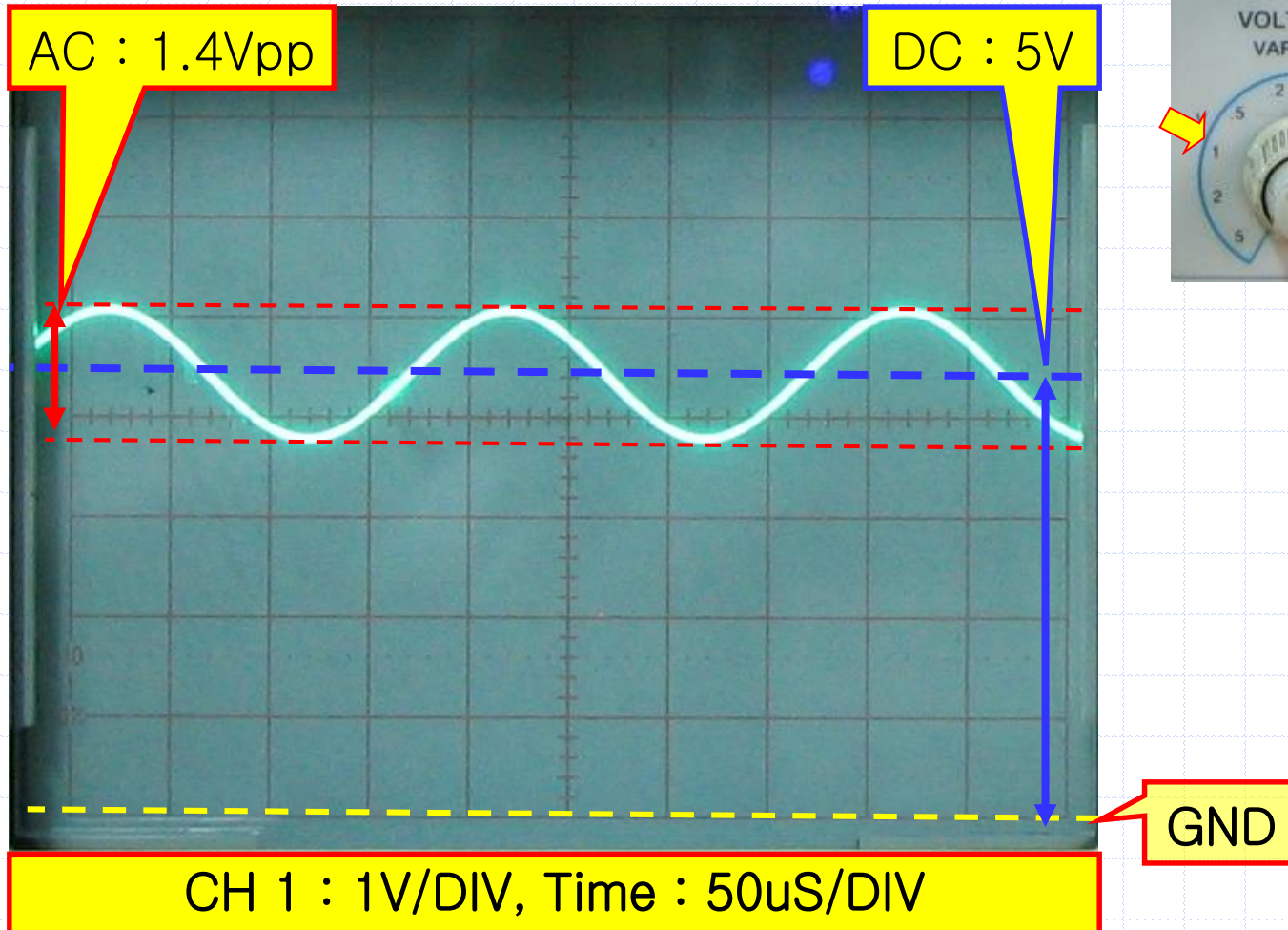

# 9-7C. 인덕터의 AC, DC 특성

✓ 인덕터의 직렬연결

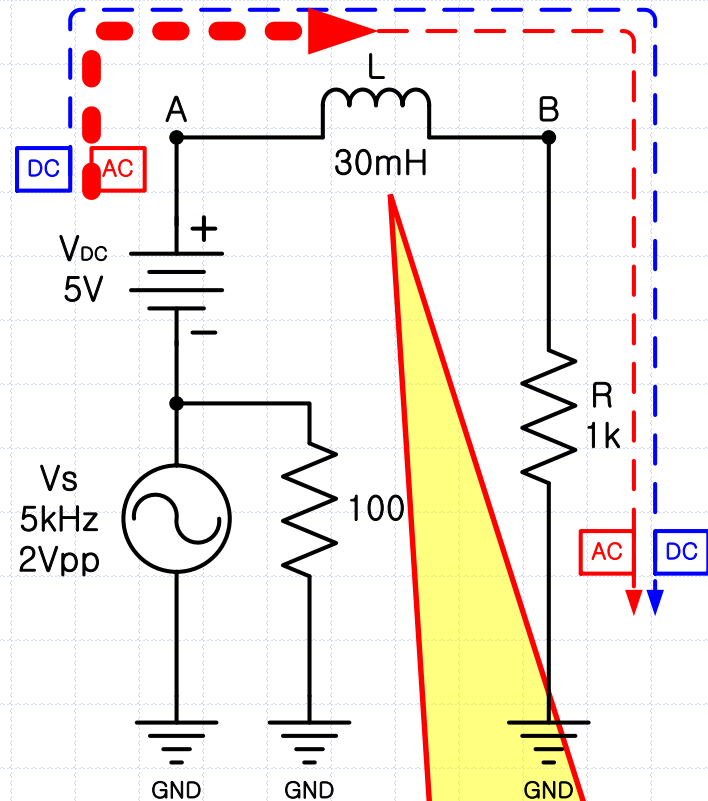
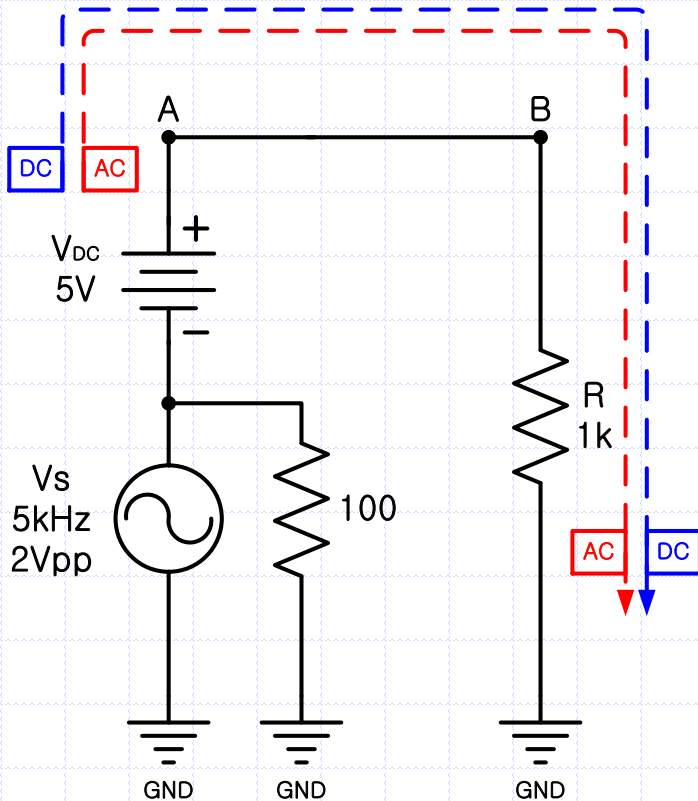

AC에 저항으로 작용하여 교류 성분을 감소시킴.

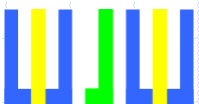

## 9-8. 위상차

- ✓ 인덕터와 캐패시터의 전압과 전류의 위상차



인덕터인 경우 전압이 빠름



캐패시터인 경우 전류가 빠름

